

**ROTHENBERGER**  
pipetool technologies at work



# MAIN CATALOG 2024



# Welcome to ROTHENBERGER!



ROTHENBERGER was founded as a trading house in 1949. As early as 1967, ROTHENBERGER developed the first system solution: the R-System. It consisted of tools for expanding, extracting and bending pipes—revolutionary equipment that enabled installers to connect pipes without fittings. This significantly accelerated the installation process.

Today, ROTHENBERGER serves installers and ACR technicians worldwide with products which have been co-developed, tested and improved by professional users.



Sculpture: ROTONDO; sculptor: Christian Hack



## Focus on users

At ROTHENBERGER, we focus on professionals in the sanitary, refrigeration and air conditioning sectors. Day after day, they face challenges on construction site and in service. They need tools they can rely on. That's why ROTHENBERGER manufactures tools and machines that are so easy to use. Our products are characterized by the highest quality and we are driven by innovation. Customers all over the world appreciate the reliability, durability and technical innovation of ROTHENBERGER pipe tools. Your demands are our motivation! To get the work done that needs to be done. Each and every day. Safe, fast and reliable.

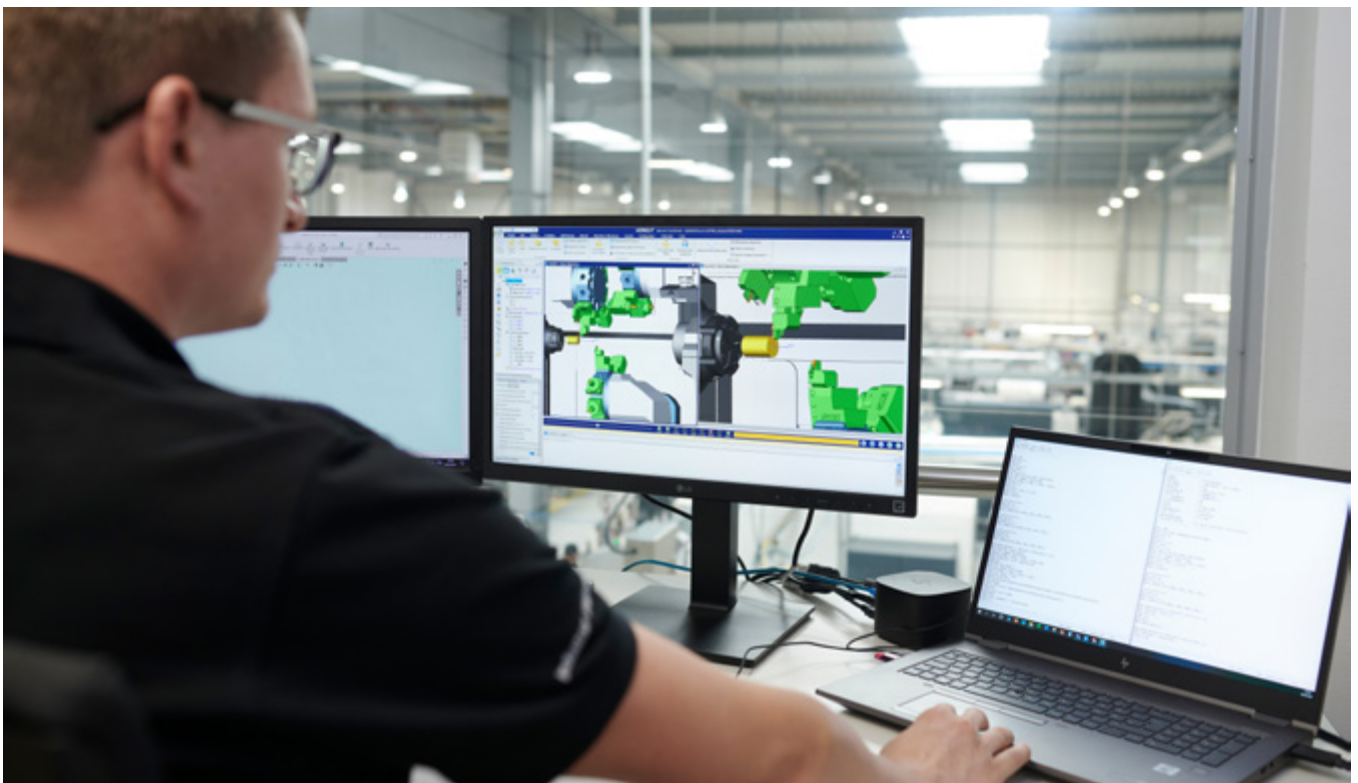


# Quality from the start

For more than 70 years, ROTHENBERGER has focused on customer satisfaction and success: from product development to manufacturing and quality control to service. We develop high quality, high performance and technically advanced pipe tools and machines.

Every development process begins with the specific needs of our users. We listen carefully, analyze the requirements and use our experience to create innovative solutions.

ROTHENBERGER's production facilities use state-of-the-art technologies and processes to develop tools and machines while maintaining a high proportion of inhouse production—by professionals for professionals!



# Sustainability means responsibility

In times of climate change and energy crisis, environmental protection is an important task for our society. ROTHENBERGER is taking responsibility and is committed to be climate-neutral by 2025. Since 2020, we have been operating photovoltaic systems with monocrystalline solar cells on the roofs of all buildings at the Kelkheim site in Germany.

Sustainability is a key concern for ROTHENBERGER. That is why we are focused on durable products, system solutions and batteries that can be used across manufacturers. This saves material, costs and valuable resources. Another great example of this is our ROCASE case system which enables safe tool storage and reduces packaging waste.



## "Sustained by"

Every tool whose product life cycle has been extended by a repair or upgrade and is sold again receives the "Sustained by" sticker.

This shows that you have made a contribution to sustainability with your purchase and that a fixed amount of the sales proceeds has been donated to a climate protection project.

# AMPShare—Powered by Bosch

ROTHENBERGER has been a founding member of the AMPShare battery platform since 2022. It is based on the 18-volt battery technology from Bosch. All AMPShare batteries and chargers are compatible with tools and machines of the cross-brand collaboration. In future, all ROTHENBERGER battery tools will be offered with an AMPShare interface.



# CAS—CORDLESS ALLIANCE SYSTEM

ROTHENBERGER has been offering a comprehensive range of CAS cordless tools since 2018. The range extends from sanitary installations to refrigeration and air conditioning technology to service area. The proven battery technology of the manufacturer-independent CORDLESS ALLIANCE SYSTEM comes from Metabo.





## Collect BONUS POINTS and benefit from rewards!

With ROTHENBERGER tools you earn bonus points that you can exchange for fantastic rewards. And the best thing about it: Our portfolio of bonus point products is constantly being expanded so that you always have a varied selection.







## Service for professionals: Always there for you!

RO SERVICE+ takes care of maintenance and repairs: our service team will quickly get your tools back up and running again. And without any delays—we pick up your tools and deliver them directly to the construction site on request.



### How to contact us}

You can contact us via many channels—via our website [rothenberger.com](https://rothenberger.com), by email to [info@rothenberger.com](mailto:info@rothenberger.com), by phone via our customer and our technical customer service hotlines.



Visit us on Facebook, Instagram, YouTube, TikTok and LinkedIn!

## TOP PRODUCT



Product details on page 253

### **R600 VarioClean: Variable pipe cleaning without cables**



The battery-operated R600 VarioClean pipe cleaning machine removes blockages over a length of 60 m—independent of external power sources. The center-lock system allows you to switch between a 16 cm and an 18 cm spiral in just a few simple steps.

The electronics offer you a choice of three variable motor speed levels for unclogging, cleaning and flushing—maximum flexibility for pipe cleaning.

## TOP PRODUCT



Product details on page 230

## ROCAM MINI HD: Convenient and precise inspection in full HD quality



With the modular pipe inspection camera ROCAM MINI HD and the 25/22 HD module, you can inspect pipes for blockages and damage quickly, precisely and conveniently. The pipe inspection camera provides images and videos in full HD quality for an optimum assessment of the situation.

With its special camera head geometry, the module has a long range and excellent arc mobility. Thanks to the integrated Wi-Fi module, images, videos and data can be exchanged quickly and easily with the app. The camera image can be transferred directly to your own smartphone.

## TOP PRODUCT



Product details on page 126

## ROMAX 4000: Powerful press machine for effortless work



The battery-powered ROMAX 4000 presses fittings with a force of 32–34 kN in just five seconds. Due to its balanced weight distribution, the press machine is ideal for effortless work—even on difficult installations.

In combination with its increased service interval of every 40,000 pressings, the ROMAX 4000 is the perfect all-rounder for fast, continuous and ergonomic work.

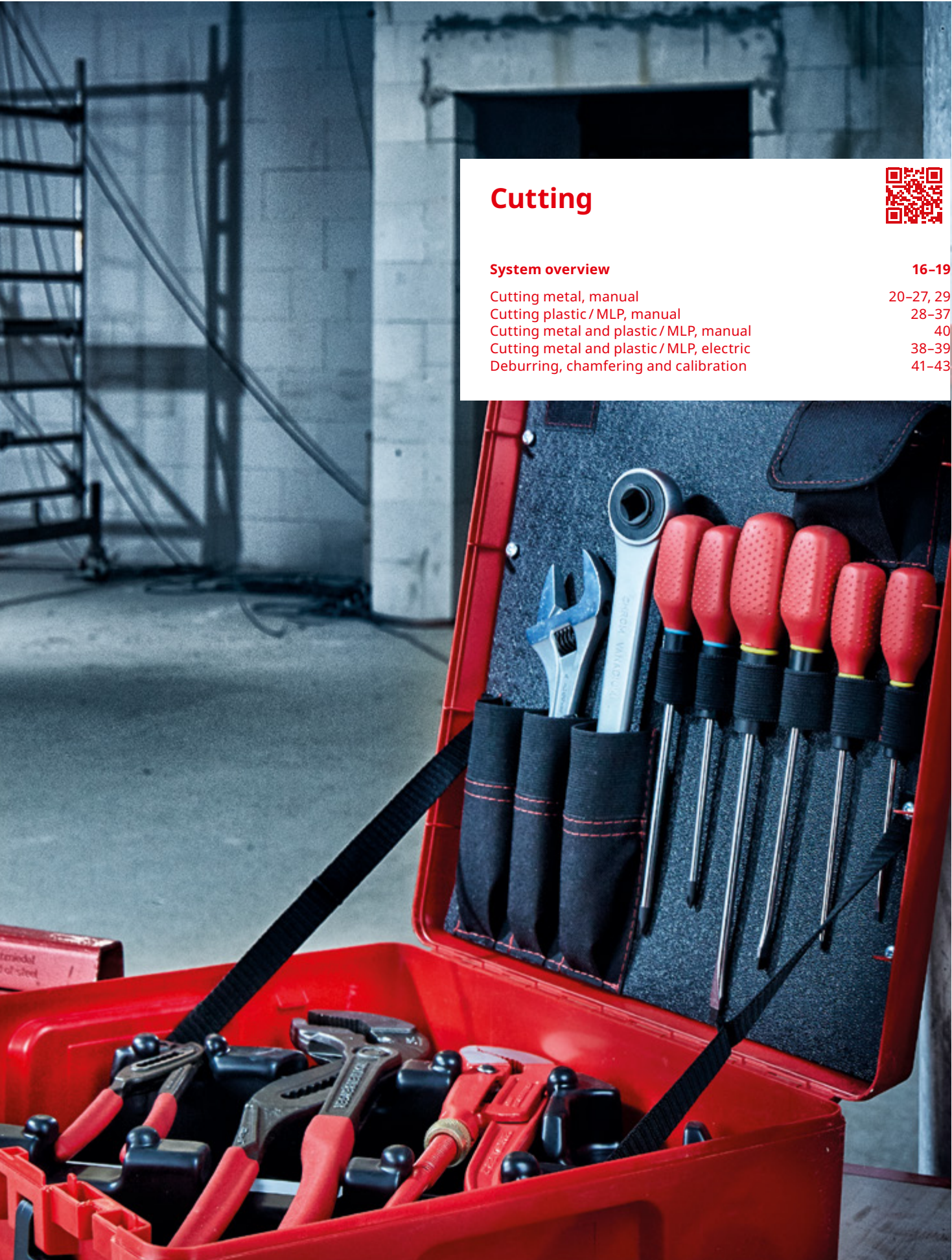
# Summary of contents

Page	Content				Chapter	
14	Cutting					1
44	Core drilling					2
70	Bending					3
94	Expanding, extracting and flaring					4
118	Pressing					5
146	Threading and grooving					6
170	Soldering and welding					7
204	Testing and leak detection					8
216	Freezing					9
224	Inspection and locating					10
236	Flushing and pipe cleaning					11
276	Plastic pipe welding					12
304	Refrigeration and air-conditioning technology					13
326	Universal tools					14
372	Additional information					



1) Detailed guarantee terms at:  
<https://rothenberger.com/gb-en/service/repairs-servicing-and-spare-parts>  
(Only in participating countries)





## Cutting



<b>System overview</b>	<b>16-19</b>
Cutting metal, manual	20-27, 29
Cutting plastic / MLP, manual	28-37
Cutting metal and plastic / MLP, manual	40
Cutting metal and plastic / MLP, electric	38-39
Deburring, chamfering and calibration	41-43

**Pipe cutters for metal**

**TUBE CUTTER 35**

**TUBE CUTTER 35 INOX**

**TUBE CUTTER 42 PRO**

**TUBE CUTTER 42 PRO INOX**



Working area	Ø 6–35 mm (1/4–1.3/8")	Ø 6–35 mm (1/4–1.3/8")	Ø 6–42 mm (1/4–1.5/8")	Ø 6–42 mm (1/4–1.5/8")
Suitable for	Cu, brass, Al, thin-walled steel pipes	Stainless steel	Cu, brass, Al, thin-walled steel pipes	Stainless steel
<b>Page</b>	<b>20</b>	<b>21</b>	<b>22</b>	<b>22</b>

**TUBE CUTTER 42 XL**

**ROTRAC 28 / 42**

**MINICUT I PRO / II PRO**

**MINICUT 2000**



Working area	Ø 6–42 mm (1/4–1.5/8")	Ø 3–28 mm (1/8–1.1/8")	Ø 3–22 mm (1/8–7/8")	Ø 3–22 mm (1/8–7/8")
Suitable for	Cu, brass, Al, thin-walled steel pipes	Cu, brass, Al, thin-walled steel pipes	Cu, brass, Al, thin-walled steel pipes	Cu, brass, Al, thin-walled steel pipes
<b>Page</b>	<b>22</b>	<b>23</b>	<b>23</b>	<b>23</b>

**MINI MAX**

**TUBE CUTTER 30 PRO**

**TUBE CUTTER 50**









**Automatic pipe cutter**



Working area	Ø 3–28 mm (1/8–1.1/8")	Ø 3–30 mm (1/8–1.1/4")	Ø 12–50 mm (1/2–2")	Ø 6–127 mm (1/4–5")
Suitable for	Cu, brass, Al, thin-walled steel pipes	Cu, brass, Al, thin-walled steel pipes	Cu, brass, Al, thin-walled steel pipes	Cu, brass, Al, thin-walled steel pipes, plastic-coated pipes
<b>Page</b>	<b>24</b>	<b>24</b>	<b>24</b>	<b>25</b>



## Pipe cutters for metal

	<b>ROSLICE</b>	<b>Chain pipe cutter</b>	<b>TUBE CUTTER 30 PRO INOX</b>	<b>TUBE CUTTER INOX</b>
				
Working area	Ø 12–22 mm (1/2–7/8")	Ø 20–100 mm (3/4–4")	Ø 3–30 mm (1/8–1.1/4")	Ø 6–60 mm (1/4–2.3/8")
Suitable for	Cu	Cu, brass, Al, thin-walled steel pipes, plastic-coated pipes	Stainless steel	Stainless steel
<b>Page</b>	<b>25</b>	<b>26</b>	<b>26</b>	<b>26</b>
	<b>TUBE CUTTER CSST</b>	<b>ENORM 4"</b>	<b>SUPER 1.1/4" and 2"</b>	<b>SUPER 1.1/4" and 2" INOX</b>
				
Working area	Ø 10–42 mm (3/8–1.5/8")	Ø 60–115 mm (2–4")	Ø 10–60 mm (3/8–2")	Ø 10–60 mm (3/8–2.3/8")
Suitable for	Corrugated INOX pipes up to 0.2 mm	Stainless steel	Stainless steel	Stainless steel
<b>Page</b>	<b>26</b>	<b>27</b>	<b>27</b>	<b>27</b>

**Plastic pipe cutters**

**TUBE CUTTER 35 MSR /  
42 PRO MSR / 42 PRO PVC**

**TUBE CUTTER  
67 / 125 / 168 PL  
Automatic**

**ROCUT Plastic Pro**

**ROWELD ROCUT**



Working area	Ø 6–42 mm (1/4–1.5/8")	Ø 6–168 mm (1/4–6.5/8")	Ø 15–50 mm (5/8–2")	Ø 32–110 mm (1.1/4–4")
Suitable for	PE, PP, PVDF, PVC, plastic-coated pipes	PE, PP, PEX, PB, PVDF, sound-isolated drain pipes	PP, PE, PVC pipes	PE, PP, PVC, PEX, PVDF, PB pipes <sup>1</sup>
<b>Page</b>	<b>28</b>	<b>28</b>	<b>30</b>	<b>35</b>

**Electrical saws for different materials**

**PIPECUT mini**



Working area	Ø 0–110 mm (0–4")
Battery system	Li-Ion
System battery	CAS
Battery type	Li-HD
Suitable for	Copper, MLP, steel, cast iron
<b>Page</b>	<b>38</b>

## Plastic shears

ROCUT 42 Twin Cut



ROCUT TC 42 Professional



ROCUT TC 32



ROCUT TC 50 Professional



Working area	Ø 0–42 mm (0–1.5/8")	Ø 0–42 mm (0–1.5/8")	Ø 0–32 mm (0–1.1/4")	Ø 0–50 mm (0–2")
Suitable for	PP, PE, PEX, PB, PVDF pipes	PP, PE, PEX, PB, PVDF, MLP pipes	PP, PE, PEX, PB, PVDF, MLP pipes	PP, PE, PEX, PB, PVDF, MLP pipes
<b>Page</b>	<b>31</b>	<b>32</b>	<b>33</b>	<b>33</b>

ROCUT TC 63 Professional



ROCUT TC 75 Professional



ROCUT TC 26



ROCUT PS 35



Working area	Ø 0–63 mm (0–2.1/2")	Ø 0–75 mm (0–3")	Ø 0–26 mm (0–1")	Ø 6–35 mm (1/4–1.3/8")
Suitable for	PP, PE, PEX, PB, PVDF, MLP pipes	PP, PE, PEX, PB, PVDF, MLP pipes	PP, PE, PEX, PB, PVDF, MLP pipes	PP, PE, PEX, PB, PVDF, MLP pipes
<b>Page</b>	<b>33</b>	<b>34</b>	<b>34</b>	<b>34</b>

ROCUT PS 26/42



Working area	Ø 6–42 mm (1/4–1.5/8")
Suitable for	PP, PE, PEX, PB, PVDF, MLP pipes
<b>Page</b>	<b>34</b>

## Cutting

### Cutting metal, manual

#### TUBE CUTTER 35

Proven pipe cutter for the precise cutting of pipes  
 $\varnothing 6-35 \text{ mm}$  (1/4-1.3/8")

For the precise cutting of copper, brass, aluminium, thin-walled steel pipes

#### Application Benefits

- Optimal for confined spaces
- Quick adjustment of the working area
- Spare cutter wheel in handle
- Cuts near to flares are possible
- Retractable internal pipe deburrer
- Rugged and robust

**Metal casing with DURAMANT coating:  
 rugged and robust**

Two guide rollers  
 with recess

Flanged cut



#### Technical Data

Working area	$\varnothing 6-35 \text{ mm}$ (1/4-1.3/8")
Material	DURAMAG magnesium
Cutting depth	3 mm

**The 100 % magnesium body is up to  
 30 % lighter than the previous model!**

Exact guidance

Precise cut

Easy turning of the  
 adjustment knob

Spare cutter wheel  
 always within reach

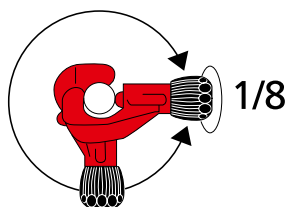
Cutter wheel  
 compartment

Spare cutting wheel  
 always at hand



Always ready to hand

Retractable pipe inner deburrer



Constant, tight  
 working radius of 123 mm



No. 070027DB

For copper and aluminium



For MLP pipes



For INOX (stainless steel) pipes



**TUBE CUTTER 35, DURAMAG**

Proven pipe cutter for the precise cutting of pipes Ø 6–35 mm (1/4–1.3/8")



For copper, brass, aluminium, thin-walled steel pipes

**Application Benefits**

- Optimal for confined spaces
- Quick adjustment of the working area
- Spare cutter wheel in handle
- Cuts near to flares are possible
- Retractable internal pipe deburrer
- Rugged and robust



Model	Weight	PU	No.
TUBE CUTTER 35, 6–35 mm (1/4–1.3/8"), DURAMAG	0.255 kg	4	70027
TUBE CUTTER 35 DURAMAG display, 6 pcs.	1.700 kg	1	070027DB

**Handtool set "Prepare to Press"**

Set for preparing pressings



For preparing copper, brass and thin-walled steel pipes with Ø 6–35 mm (1/4–1.3/8") for subsequent pressings



Set (No. 1000002002) includes: TUBE CUTTER 35, Ø 6–35 mm (No. 70027), internal and external deburrer Ø 6–35 mm (No. 1500000237), permanent-marker "Prepare to Press" (No. 1500002640), ROBOX B2350 (No. 1500002641)

Model	Weight	PU	No.
Handtool set "Prepare to Press", 6–35 mm (1/4–1.3/8")	0.460 kg	1	1000002002

**TUBE CUTTER 35 INOX, DURAMAG**

Proven pipe cutter for the precise cutting of pipes Ø 6–35 mm (1/4–1.3/8")



For stainless steel pipes

**Application Benefits**

- Hardened, special cutter wheel made of high-alloyed steel
- External burr-free cutting
- Stainless steel guide rolls, cuts near flares possible
- Optimum use in tight places
- Quick adjustment of the working area
- Retractable pipe internal deburrer
- Rugged and robust



INOX

Model	Weight	PU	No.
TUBE CUTTER 35 INOX, 6–35 mm (1/4–1.3/8"), DURAMAG	0.255 kg	4	70055

**TUBE CUTTER 35 INOX with cutting wheels**

Pipe cutter for cutting stainless steel pipes with matching cutting wheels



TUBE CUTTER 35 INOX for cutting stainless steel pipes



INOX

Set (No. 1000002222) includes: TUBE CUTTER 35 INOX, Ø 6–35 mm, DURAMAG (No. 70055), cutter wheel for TUBE CUTTER 35, TUBE CUTTER 30 Pro and TUBE CUTTER 42 XL (No. 070056D), ROBOX B2350 (No. 1500002641)

Model	Weight	PU	No.
TUBE CUTTER 35 INOX with cutting wheels and ROBOX	0.500 kg	1	1000002222

### TUBE CUTTER 42 PRO

Proven pipe cutter for the precise cutting of pipes Ø 6–42 mm (1/4–1.5/8")



For copper, brass, aluminium, thin-walled steel pipes

#### Application Benefits

- Optimal for confined spaces
- Quick adjustment of the working area
- Spare cutter wheel in handle
- Cuts near to flares are possible
- Retractable internal pipe deburrer
- Rugged and robust



Model	Weight	PU	No.
TUBE CUTTER 42 PRO, 6–42 mm (1/4–1.5/8")	0.545 kg	4	70029

### TUBE CUTTER 42 PRO INOX

Proven pipe cutter for the precise cutting of stainless steel pipes Ø 6–42 mm (1/4–1.5/8")

For cutting stainless steel pipes

#### Application Benefits

- Hardened, special cutter wheel made of high-alloyed steel
- External burr-free cutting
- Stainless steel guide rolls, cuts near flares possible
- Optimum use in tight places
- Quick adjustment of the working area
- Retractable pipe internal deburrer
- Rugged and robust



INOX

Model	Weight	PU	No.
TUBE CUTTER 42 PRO INOX, 6–42 mm (1/4–1.5/8")	0.545 kg	1	70070

### TUBE CUTTER 42 XL

Proven pipe cutter for the precise cutting of pipes Ø 6–42 mm (1/4–1.5/8")

For copper, brass, aluminium, stainless steel and thin-walled steel pipes with a wall thickness of up to 1.2 mm

#### Application Benefits

- New cutter wheel: 20 × more cuts<sup>1</sup>
- Suitable for thin-walled pipes starting at a wall thickness of 0.5 mm
- Quick adjustment of the pipe diameter by easy turning of the adjustment knob
- Spare cutter wheel in handle compartment
- Retractable internal pipe deburrer

Model	Weight	PU	No.
TUBE CUTTER 42 XL, 6–42 mm (1/4–1.5/8")	0.500 kg	1	1000001748
Spare cutter wheel, 5 pcs.	0.020 kg	1	070056D



1) Stainless steel compared to TUBE CUTTER 42 Pro

### ROTRAC 28

High-precision pipe cutter Ø 3–28 mm (1/8–1.1/8")



For cutting copper, brass, aluminium and thin-walled steel pipes

#### Application Benefits

- Constant working radius
- Cast aluminium design
- Protection of the cutter wheel with the rolling stop
- Retractable internal deburrer and spare cutter wheel in handle
- Protected screw spindle—protection against dirt and jamming



Casing made in one cast

Stable and long-lasting

Model	Weight	PU	No.
ROTRAC 28, 3–28 mm (1/8–1.1/8")	0.220 kg	1	70010
ROTRAC 28 PLUS Chrome, Limited Edition	0.220 kg	1	1000000046
Spare axle	0.005 kg	1	70080
Spare cutter wheel INOX	0.002 kg	1	070007X
Spare cutter wheel Cu, Al, Br, 3 pcs.	0.020 kg	1	070007D

### ROTRAC 42

High-precision pipe cutter Ø 6–42 mm (1/4–1.5/8")



For cutting copper, brass, aluminium and thin-walled steel pipes

#### Application Benefits

- Constant working radius
- Cast aluminium design
- Protection of the cutter wheel with the rolling stop
- Retractable internal deburrer and spare cutter wheel in handle
- Protected screw spindle—protection against dirt and jamming



Casing made in one cast

Stable and long-lasting

Model	Weight	PU	No.
ROTRAC 42, 6–42 mm (1/4–1.5/8")	0.255 kg	1	70011
Spare axle	0.005 kg	1	70080
Spare cutter wheel INOX	0.002 kg	1	070007X
Spare cutter wheel Cu, Al, Br, 3 pcs.	0.020 kg	1	070007D

### MINICUT I PRO / II PRO

Copper pipe cutter Ø 3–22 mm (1/8–7/8")

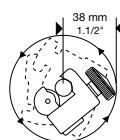


For cutting copper, brass, aluminium and thin-walled steel pipes

#### Application Benefits

- Compact design with small working radius 38 mm (1.1/2") I PRO and 42 mm (1.5/8") II PRO allows use in hard-to-reach places
- Effortless pressure control with the large knurled knob and compact design
- Two guide rollers with recess for cuts near flares
- Monoblock design allows precision

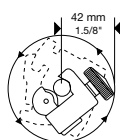
Ideal for maintenance and repair work!



No. 70401



No. 70402



No. 70402

Model	Weight	PU	No.
MINICUT I PRO, 3–16 mm (1/8–5/8")	0.115 kg	4	70401
MINICUT I PRO C, 3–16 mm (1/8–5/8")	0.120 kg	4	070401C
MINICUT II PRO, 6–22 mm (1/4–7/8")	0.125 kg	4	70402
Spare cutter wheel Cu, Br, Al, Fe, 5 pcs.	0.020 kg	1	070017D

### MINICUT 2000

Copper pipe cutter Ø 3–22 mm (1/8–7/8")



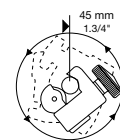
For cutting copper, brass, aluminium and thin-walled steel pipes

#### Application Benefits

- Compact design with small working radius 45 mm (1.3/4") allows use in hard-to-reach places
- Effortless pressure control with the large knurled knob and compact design
- Two guide rollers with recess for cuts near flares
- Ergonomic design of body and knob with seating surface for the hand during turning



No. 70105



Model	Weight	PU	No.
MINICUT 2000, 3–22 mm (1/8–7/8")	0.140 kg	4	70105
Spare axle	0.005 kg	1	70041
Spare cutter wheel Cu, Br, Al, Fe, 5 pcs.	0.020 kg	1	070017D

## Cutting

### Cutting metal, manual

#### MINI MAX

##### Copper pipe cutter Ø 3–28 mm (1/8–1.1/8")



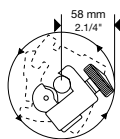
For cutting copper, brass, aluminium and thin-walled steel pipes

##### Application Benefits

- Compact design with very small working radius 58 mm (2.1/4") allows use in hard-to-reach places
- Effortless pressure control with the large knurled knob and compact design
- Two guide rollers with recess for cuts near flares
- Ergonomic design of body and knob with seating surface for the hand during turning



No. 70015



Model	Weight	PU	No.
MINI MAX, 3–28 mm (1/8–1.1/8")	0.270 kg	4	70015
Spare cutter wheel Cu, Br, Al, Fe, 5 pcs.	0.020 kg	1	070017D
Spare axle	0.005 kg	1	70041

#### TUBE CUTTER 30 PRO

##### Copper pipe cutter Ø 3–30 mm (1/8–1.1/4")

For cutting copper, brass, aluminium and thin-walled steel pipes

##### Application Benefits

- Two guide rollers with recess for cuts near flares
- Retractable internal deburrer and spare cutter wheel in handle



Model	Weight	PU	No.
TUBE CUTTER 30 PRO, 3–30 mm (1/8–1.1/4")	0.305 kg	4	71019
Spare cutter wheel Cu, Br, Al, Fe, 5 pcs.	0.020 kg	1	070017D
Spare axle	0.005 kg	1	70041

#### TUBE CUTTER 50

##### Copper pipe cutter Ø 12–50 mm (1/2–2")

For cutting copper, brass, aluminium and thin-walled steel pipes

##### Application Benefits

- Two guide rollers with recess for cuts near flares
- Retractable internal deburrer and spare cutter wheel in handle

##### Technical Data

Working area	Ø 12–50 mm (1/2–2")
Cutting depth	1.2 mm
Suitable for	Cu, brass, Al, thin-walled steel pipes



Model	Weight	PU	No.
TUBE CUTTER 50, 12–50 mm (1/2–2")	0.520 kg	1	70065
Spare axle	0.010 kg	1	70006



## Automatic pipe cutter

### Telescopic pipe cutter Ø 6-127 mm (1/4-5")

For cutting copper, brass, aluminium and thin-walled steel pipes as well as sound-insulated pipes

#### Application Benefits

- Retractable internal deburrer and spare cutter wheel in handle
- Monoblock design
- Quick adjustment with the ratchet telescopic guide with automatic spring-driven release
- Self-clamping prevents release due to quick adjustment during the cutting process



No. 70030

Model	Weight	PU	No.
Automatic pipe cutter Size 1, 6-67 mm (1/4-2.5/8")	0.755 kg	1	70030
Automatic pipe cutter Size 2, 50-127 mm (2-5")	1.875 kg	1	70142
Spare blade for GRATFIX HSS Size 1, Universal	0.005 kg	10	21652
Spare internal pipe deburrer complete Size 1	0.005 kg	1	750004100

Model	Weight	PU	No.
Spare axle Size 1	0.020 kg	1	70042
Spare cutter wheel for Automatic pipe cutter Size 2, 2 pcs.	0.020 kg	1	070057D
Spare cutter wheel Cu, Br, Al, Fe, 5 pcs.	0.020 kg	1	070017D

## ROSLICE

### Copper pipe cutter Ø 12-22 mm (1/2-7/8")

#### Application Benefits

- Quick cutting of copper pipes with less turns
- No deformation of the pipe: self-clamping and self-alignment
- Less space required, ideal for hard-to-reach places
- Reliable hold with the non-slip surface



#### Ergonomic form

Less space needed,  
ideal for hard-to-reach places

#### Non-slip surface

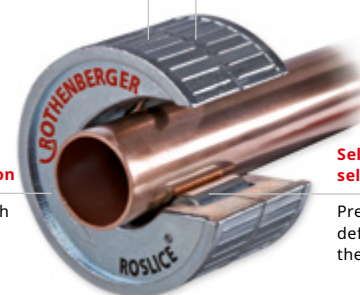
Reliable grip

#### Indicates rotating direction

Quick cutting with  
just a few turns

#### Self-clamping and self-alignment

Prevents the  
deformation of  
the pipe



Model	Weight	PU	No.
ROSLICE, 12 mm	0.240 kg	1	88812
ROSLICE, 15 mm	0.230 kg	1	88815
ROSLICE, 18 mm	0.260 kg	1	88818
ROSLICE, 22 mm	0.250 kg	1	88822
ROSLICE, 3/4"	0.240 kg	1	88832
Spare cutter wheel, 12 mm (1/2"), 5 pcs.	0.036 kg	1	088840D
Spare cutter wheel, 15 mm and 22 mm (5/8 and 7/8"), 5 pcs.	0.035 kg	1	088841D
Spare cutter wheel, 18 mm, (1/2-3/4"), 5 pcs.	0.037 kg	1	088842D

Pipe cutting possible near the wall



## Cutting

### Cutting metal, manual

#### Chain pipe cutter

For pipes Ø 20–100 mm (3/4–4")

For cutting copper, brass, aluminium and thin-walled steel pipes as well as sound-insulated pipes

##### Application Benefits

- Ideal for working in confined spaces, e.g. parallel-running pipes
- Robust chain with 15 mini cutter wheels, two-step adjustment, chrome-plated with plastic covered handles



Model	Weight	PU	No.
Chain pipe cutter, 20–100 mm (7/8–4")	0.570 kg	1	70285
Spare cutter wheel chain, 20–100 mm (7/8–4")	0.180 kg	1	70286

#### TUBE CUTTER INOX

Ratchet telescopic pipe cutter for the precise cutting of stainless steel pipes Ø 6–60 mm (1/4–2.3/8")

For cutting stainless steel pipes

##### Application Benefits

- Quick adjustment with the ratchet telescopic guide with automatic spring-driven release



12 × ball bearings!

INOX

Model	Weight	PU	No.
TUBE CUTTER INOX, 6–60 mm (1/4–2.3/8")	0.305 kg	1	70340
Spare cutter wheel, 2 pcs.	0.020 kg	1	70341

#### TUBE CUTTER 30 PRO INOX

Stainless steel pipe cutter for the precise cutting of stainless steel pipes Ø 3–30 mm (1/8–1.1/4")

For cutting stainless steel and thin-walled steel pipes

##### Application Benefits

- Retractable internal deburrer and spare cutter wheel in handle
- Two guide rollers with recess for cuts near flares



INOX

Model	Weight	PU	No.
TUBE CUTTER 30 PRO INOX, 3–30 mm (1/8–1.1/4")	0.305 kg	1	71085
Spare axle	0.005 kg	1	70041
Spare cutter wheel, 5 pcs.	0.020 kg	1	070056D

#### TUBE CUTTER CSST

Pipe cutter for the precise cutting of corrugated INOX pipes 8–42 mm (5/16–1.5/8")

For cutting INOX corrugated pipes with a wall thickness of up to 0.2 mm

##### Application Benefits

- Stability provided by two wide rubber rollers
- Quick adjustment to the pipe diameter
- Spare cutter wheel in handle compartment



Model	Weight	PU	No.
TUBE CUTTER CSST, 8–42 mm (5/16–1.5/8")	0.500 kg	1	1000001747
Spare cutter wheel, CSST pipe, 5 pcs.	0.010 kg	1	1000002077

**ENORM 4"****Steel pipe cutter Ø 60–115 mm (2–4")****Application Benefits**

- Wide rollers for secure guiding of cutter wheel on pipe
- Easy pressure control for optimum force transmission on to the pipe
- Long service life with the hardened cutter wheel made of high-alloyed steel
- Burr-free cutting allows immediate thread cutting



Model	Weight	PU	No.
ENORM, 60–115 mm (2–4")	7.105 kg	1	70060
Spare axle, 60–115 mm (2–4")	0.005 kg	1	70064
Spare cutter wheel, 60–115 mm (2–4"), 2 pcs.	0.020 kg	1	070061D

Handle (included in delivery)

**SUPER 1.1/4" and 2"****Stainless steel pipe cutter Ø 10–60 mm (1/4–2")****Application Benefits**

- Wide rollers for secure guiding of cutter wheel on pipe
- Easy pressure control for optimum force transmission on to the pipe
- Long service life with the hardened cutter wheel made of high-alloyed steel
- Burr-free cutting allows immediate thread cutting

Precise cutting of stainless steel pipes

**INOX**

Model	Weight	No.	Model	Weight	No.
SUPER, 10–42 mm (1/4–1.1/4")	1.040 kg	70040	SUPER INOX, 10–42 mm (3/8–1.5/8")	1.140 kg	70086
SUPER, 10–60 mm (1/4–2")	2.155 kg	70045	SUPER INOX, 10–60 mm (3/8–2.3/8")	2.155 kg	70087
Spare cutter wheel, 10–42 mm (3/8–1.1/4"), 3 pcs.	0.020 kg	070046D	Spare cutter wheel, 10–42 mm (3/8–1.5/8"), 2 pcs.	0.020 kg	070088D
Spare axle, 10–42 mm (1/4–1.1/4")	0.005 kg	701011500	Spare axle, 10–42 mm (3/8–1.5/8")	0.005 kg	701011500
Spare cutter wheel, 10–60 mm (1/4–2"), 3 pcs.	0.020 kg	070051D	Spare cutter wheel, 10–60 mm (3/8–2.3/8"), 2 pcs.	0.020 kg	070089D
Spare axle, 10–60 mm (1/4–2")	0.005 kg	70053	Spare axle, 10–60 mm (3/8–2.3/8")	0.005 kg	70053

## Cutting

### Cutting plastic / MLP, manual

#### TUBE CUTTER 35 MSR / 42 PRO MSR / 42 PRO PVC

**Proven pipe cutter for the precise cutting of pipes  
Ø 6–42 mm (1/4–1.1/4")**

TUBE CUTTER 35 MLP and 42 PRO MLP for multi-layer composite pipes TUBE CUTTER 42 PRO PVC for PVC pipes



#### Application Benefits

- Space-saving work, also in confined spaces, uniform, small working radius of 123 mm
- Right-angled and burr-free cutting, precise telescopic guidance
- Fast and simple adjustment of the working range due to the feed being synchronised with the feeder rotation
- Optimum, fatigue-free operation with the optimised ergonomic handle
- Only one tool for cutting and deburring due to integrated, retractable internal pipe deburrer
- Spare cutter wheel in the handle

#### Technical Data

TUBE CUTTER 35 MSR 6–35 mm (1/4–1.3/8")

TUBE CUTTER 42 PRO MSR 6–42 mm (1/4–1.5/8")

TUBE CUTTER 42 PRO PVC 6–42 mm (1/4–1.5/8")

Model	Weight	PU	No.
TUBE CUTTER 35 MSR, 6–35 mm (1/4–1.3/8"), DURAMAG	0.255 kg	4	70108
Spare cutter wheel TUBE CUTTER 35/42 MSR, 5 pcs.	0.020 kg	1	070188D



No. 70108

Model	Weight	PU	No.
TUBE CUTTER 42 PRO MSR, 6–42 mm (1/4–1.5/8")	0.550 kg	1	70109
TUBE CUTTER 42 PRO PVC, 6–42 mm (1/4–1.5/8")	0.550 kg	4	70072
Spare cutter wheel TUBE CUTTER 42 PVC, 3 pcs.	0.030 kg	1	070028D

#### TUBE CUTTER 67 / 125 / 168 PL Automatic

**Telescopic ratchet pipe cutter Ø 6–168 mm (1/4–6.5/8")**

For precise cutting of PP, PE, PEX, PB and PVDF pipes as well as sound-insulated drain pipes



#### Application Benefits

- Maximum strength with the monoblock aluminium construction
- Optimum, fatigue-free operation with the ergonomically optimised metal handle
- Fast adjustment to the outer tube diameter with the telescopic ratchet guide
- Fast opening with automatic retraction
- Internal pipe deburrer retracts into cutter body
- Hardened, specially sharpened cutter wheels

#### Technical Data

Working area	Ø 6–168 mm (1/4–6.5/8")
Material	DURAMAG magnesium
Suitable for	PE, PP, PEX, PB, PVDF, sound-insulated drain pipes

Removable internal pipe deburrer



No. 70033

Model	Weight	PU	No.
TUBE CUTTER PL Automatic, 6–67 mm (1/4–2.5/8")	0.700 kg	4	70031
TUBE CUTTER PL Automatic, 50–125 mm (2–5")	1.600 kg	1	70032
TUBE CUTTER PL Automatic, 110–168 mm (4–6.5/8")	1.700 kg	1	70033

## Pipe cutters, cutting wheels and spare parts

Only original ROTHENBERGER cutting wheels made of high-alloyed hardened steel guarantee an exact, right-angled cut



Pipe cutter type	Model for pipe-Ø	No.	Cutting wheel No.	Sizes d / L / D mm	Cutting depth mm	Spare axle No.	Ø mm Length mm Thread	Spare roller No.	Deburring blade No.	Application area
MINICUT I PRO	3-16 mm	70401	070017D	4.8/5.9/18.5	3.0	70041	4.7/14/M3	70023	—	Copper pipe (Cu), brass pipe (Ms), aluminium pipe (Al), thin-walled steel pipe (Fe), PVC hard plastic pipe, plastic-coated pipe
MINICUT II PRO	6-22 mm	70402	070017D	4.8/5.9/18.5	3.0	70041	4.7/14/M3	70023	—	Copper pipe (Cu), brass pipe (Ms), aluminium pipe (Al), thin-walled steel pipe (Fe), PVC hard plastic pipe, plastic-coated pipe
MINICUT 2000	3-22 mm	70105	070017D	4.8/5.9/18.5	3.0	70041	4.7/14/M3	—	—	Copper pipe (Cu), brass pipe (Ms), aluminium pipe (Al), thin-walled steel pipe (Fe), PVC hard plastic pipe, plastic-coated pipe
MINIMAX	3-28 mm	70015	070017D	4.8/5.9/18.5	3.0	70041	4.7/14/M3	—	—	Copper pipe (Cu), brass pipe (Ms), aluminium pipe (Al), thin-walled steel pipe (Fe), PVC hard plastic pipe, plastic-coated pipe
TUBE CUTTER 30 PRO	3-30 mm	71019	070017D	4.8/5.9/18.5	3.0	70041	4.7/14/M3	70067	—	Copper pipe (Cu), brass pipe (Ms), aluminium pipe (Al), thin-walled steel pipe (Fe), PVC hard plastic pipe, plastic-coated pipe
TUBE CUTTER 35 + 35 C	6-35 mm	070027(C)	070017D	4.8/5.9/18.5	3.0	70041	4.7/14/M3	70067	21652	Copper pipe (Cu), brass pipe (Ms), aluminium pipe (Al), thin-walled steel pipe (Fe), PVC hard plastic pipe, plastic-coated pipe
TUBE CUTTER 42 PRO	6-42 mm	70029	070017D	4.8/5.9/18.5	3.0	70041	4.7/14/M3	70067	21652	Copper pipe (Cu), brass pipe (Ms), aluminium pipe (Al), thin-walled steel pipe (Fe), PVC hard plastic pipe, plastic-coated pipe
TUBE CUTTER 35 MSR	6-35 mm	70108	070188D	4.8/5.9/19.3	4.0	70041	4.7/14/M3	70067	21652	Copper pipe (Cu), brass pipe (Ms), aluminium pipe (Al), thin-walled steel pipe (Fe), PVC hard plastic pipe, plastic-coated pipe
TUBE CUTTER 42 PRO MSR	6-42 mm	70109	070188D	4.8/5.9/19.3	4.0	70041	4.7/14/M3	70067	21652	Copper pipe (Cu), brass pipe (Ms), aluminium pipe (Al), thin-walled steel pipe (Fe), PVC hard plastic pipe, plastic-coated pipe
TUBE CUTTER 50	12-50 mm	70065	070017D	4.8/5.9/18.5	3.0	70006	4.7/16/M4	—	—	Multi-layered composite pipe
AUTOMATIC pipe cutter Size 1	6-67 mm	70030	070017D	4.8/5.9/18.5	3.0	70042	4.7/16/M4	—	21652	Cu, Ms, Al, Fe thin-walled
AUTOMATIC pipe cutter Size 1	6-67 mm	70031	070028D	4.8/5.9/23.6	7.0	70042	4.7/16/M4	—	21652	PE, PP, VPE, PB and PVDF pipes
AUTOMATIC pipe cutter Size 2	50-127 mm	70142	070057D	8.0/14.0/29.0	7.0	751004200	7.9/23.5/1/4"	—	21652	thin-walled Cu, Ms, Al, Fe
AUTOMATIC pipe cutter Size 2	50-127 mm	70032	055054D	8.0/13.0/40.0	13.0	751004200	7.9/23.5/1/4"	—	21652	PE, PP, VPE, PB and PVDF pipes
AUTOMATIC pipe cutter Size 2	50-127 mm	70032	055053D	8.0/13.0/30.5	8.0	751004200	7.9/23.5/1/4"	—	21652	thin-walled PP pipes
AUTOMATIC pipe cutter Size 2	50-127 mm	70032	055074D	8.0/11.0/45.0	16.0	751004200	7.9/23.5/1/4"	—	21652	PE, PP, VPE, PB and PVDF pipes
AUTOMATIC pipe cutter Size 3	100-168 mm	70033	055074D	8.0/11.0/45.0	16.0	751004200	7.9/23.5/1/4"	—	21652	PE, PP, VPE, PB and PVDF pipes
AUTOMATIC pipe cutter Size 3	100-168 mm	70033	055053D	8.0/11.0/30.5	8.6	751004200	7.9/23.5/1/4"	—	21652	thin-walled PP pipes
TUBE CUTTER 28	3-28 mm	70010	070007D	4.8/3.0/16.0	2.5	70080 + 70081	4.7/9/SR	80679	—	Cu, Ms, Al, Fe thin-walled
TUBE CUTTER 42	3-42 mm	70011	070007D	4.8/3.0/16.0	2.5	70080 + 70081	4.7/9/SR	80679	—	Cu, Ms, Al, Fe thin-walled
TUBE CUTTER 42 PRO PVC	6-42 mm	70072	070028D	4.8/5.9/23.6	7.0	70041	4.7/14/M3	70067	—	PE, PP, VPE, PB and PVDF pipes
Steel pipe cutter SUPER	3/8-1.1/4"	70040	070046D	7.5/14.0/25.7	5.5	701011500	7.4/30/—	70047	—	Steel pipe (Fe)
Steel pipe cutter SUPER	3/8-2"	70045	070051D	9.0/17.0/31.5	6.0	70053	8.9/35/—	70052	—	Steel pipe (Fe)
Steel pipe cutter ENORM	2-4"	70060	070061D	9.7/20.0/41.0	8.0	70064	9.4/52/—	70063	—	Steel pipe (Fe)
TUBE CUTTER 30 PRO INOX	3-30 mm	71085	070056D	4.8/5.9/18.5	5.5	70041	4.7/14/M3	70068	—	Stainless steel pipe
TUBE CUTTER INOX	10-54 mm	70340	70341	5.0/21.0/30.0	3.5	753000700	4.7/14/M3	70068	21652	Stainless steel pipe
TUBE CUTTER 35 INOX	6-35 mm	70055	070056D	4.8/5.9/18.5	4.0	70041	4.7/14/M3	70068	21652	Stainless steel pipe
TUBE CUTTER 42 PRO INOX	6-42 mm	70070	070056D	4.8/5.9/18.5	4.0	70041	4.7/14/M3	70068	21652	Stainless steel pipe
SUPER INOX	3/8-1.1/4"	70086	070088D	4.8/5.9/19.3	4.0	701011500	7.4/30/—	70047	—	Stainless steel pipe
SUPER INOX	3/8-2"	70087	070089D	9.0/19.0/31.5	7.0	70053	7.4/35/—	70052	—	Stainless steel pipe
Chain pipe cutter	100 mm	70285	—	4.0/3.8/17.8	3.0	—	—	70286	70286	Cu, Ms, Al, Fe thin-walled

## Cutting

### Cutting plastic / MLP, manual

#### ROCUT Plastic Pro

##### One tool, two pipe diameters

The pipe cutter ROCUT Plastic Pro cuts PE, PP and PVC pipes. It cuts the pipe right angled, quickly and with only a few turns.

##### Application Benefits

- One tool can cut two pipe diameters and three different sizes are available
- Cut pipes with a wall thickness of up to 3.5 mm
- Requires only little working area and allows work in confined spaces

##### Technical Data

Working area	Ø 15–50 mm
Cutting depth	2–3.5 mm
Suitable for	PP, PE, PVC

1

##### Two diameters

One tool for two diameters

##### Cassette for spare blade

Practical storage for replacement cutting sheets



##### Hinge

Easy to set up on the pipe

##### Cutting blade

Optimally placed for straight cut

Model	Weight	PU	No.
ROCUT Plastic Pro, 15–22 mm	0.340 kg	1	1000003051
ROCUT Plastic Pro, 32–40 mm	0.540 kg	1	1000003052
ROCUT Plastic Pro, 40–50 mm	0.540 kg	1	1000003106



## ROCUT 42 Twin Cut

Shear for cutting all common plastic pipes with a diameter of 0–42 mm (0–1.5/8")

With the ROCUT 42 Twin Cut you can cut faster, clean and straight and with even less effort on all common plastic pipes up to 42 mm (0–1.5/8").

### Application Benefits

- Combines due to its unique function two shears: pipes can be cut in the one cut or ratchet cut function
- Direct cut function: Pipes up to 20 mm can be cut directly with one stroke
- Ratchet cut function: if the pipe dimension is too large or the material too thick for a one cut, the shear automatically switches into the ratchet mode

### Technical Data

Working area direct cut	Ø 0–20 mm
Working area ratchet cut	Ø 20–42 mm
Blade	V-Contour, PTFE coated
Suitable for	PP, PE, PEX, PB, PVDF

**PTFE coated blade**  
Less force needed for a straight cut

**Innovative mechanism**  
Shear automatically switches from one to ratchet cut function

**Non-slip handles**  
Good grip while working

**Symmetric reset lever**  
Automatic, controlled opening of the blade at the push of a button

**Two stage pipe holder**  
For pipes 0–20 and 20–42 mm—less cutting effort, less deformation

Powerful cutting with the ratchet function.

With the one cut function pipes can be cut 80 % faster. You also save time since little calibration is needed.<sup>1</sup>



Model	Weight	PU	No.
ROCUT 42 Twin Cut, 0–42 mm (0–1.5/8")	0.550 kg	1	1000003011
Spare blade, 0–42 mm (0–1.5/8")	0.120 kg	1	1000003104

<sup>1</sup>) Internally tested. In comparison to the previous ROCUT TC 42 with a 16 mm pipe.

## Cutting

### Cutting plastic / MLP, manual

#### ROCUT TC 42 Professional

Shear for cutting all common plastic pipes with a diameter of Ø 0–42 mm (0–1.5/8")

With the ROCUT 42 TC Professional you can cut faster, clean and straight and with even less effort on all common plastic pipes up to Ø 42mm (1.5/8").



#### Application Benefits

- Minimum effort during cutting
- Precise right-angled cuts
- Pin-point precision without deformation
- Precise pressure transfer and guided cutter feed
- Automatic, controlled opening of the blade at the push of a button
- Secure grip with the rubberised handles
- Shear arms lockable in transport position

#### Technical Data

Working area	Ø 0–42 mm (0–1.5/8")
Suitable for	PP, PE, PEX, PB, PVDF

1



Rust-free steel blade with V-edge



Ideally meshed cutting curve



Shear arms lockable in transport position



#### Model

ROCUT TC 42 Professional, 0–42 mm (0–1.5/8")

#### Weight

0.447 kg

#### PU

4

#### No.

52000



**ROCUT TC 32**

Shear for cutting all common plastic pipes with a diameter of  $\varnothing 0-32$  mm (0-1.1/4")

Manual plastic pipe shear for cutting PP-, PE-, PEX-, PB- and PVDF pipes

**Application Benefits**

- Stainless steel blade with V-edge: pin-point precision without deformation
- Minimum effort: ideally meshed cutting curve
- Wide pipe support: Precise right-angled cuts
- Release the lever with the push of a button: Automatic and controlled opening of the blade
- Transport lock: For better transportation shear arms can be locked after cutting



Model	Weight	PU	No.
ROCUT TC 32, 0-32 mm (0-1.1/4")	0.220 kg	4	52040

**ROCUT TC 50 Professional**

Plastic pipe shears up to  $\varnothing 0-50$  mm (0-2")

For precise cutting of PP, PE, PEX, PB, PVC, PVDF and MLP pipes

**Application Benefits**

- Minimum effort during cutting
- Precise right-angled cuts
- Pin-point precision without deformation
- Precise pressure transfer and guided cutter feed
- Automatic, controlled opening of the blade at the push of a button
- Secure grip with the rubberised handles
- Shear arms lockable in transport position



Model	Weight	PU	No.
ROCUT TC 50 Professional, 0-50 mm (0-2")	0.600 kg	6	52010

**ROCUT TC 63 Professional**

Plastic pipe shears up to  $\varnothing 0-63$  mm (0-2.1/2")

For precise cutting of PP, PE, PEX, PB, PVC, PVDF and MLP pipes

**Application Benefits**

- Minimum effort during cutting
- Precise right-angled cuts
- Pin-point precision without deformation
- Precise pressure transfer and guided cutter feed
- Automatic, controlled opening of the blade at the push of a button
- Secure grip with the rubberised handles
- Shear arms lockable in transport position



Model	Weight	PU	No.
ROCUT TC 63 Professional, 0-63 mm (0-2.1/2")	0.700 kg	6	52030

## Cutting

### Cutting plastic / MLP, manual

#### ROCUT TC 75 Professional

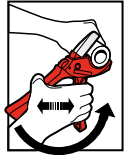
Manual plastic pipe shear for cutting PP-, PE-, PEX-, PB- and PVDF pipes



Model	Weight	PU	No.
ROCUT TC 75 Professional, 0-75 mm (0-3")	1.600 kg	1	52015

#### ROCUT TC 26

Manual plastic pipe shear for cutting PP-, PE-, PEX-, PB- and PVDF pipes



Model	Weight	PU	No.
ROCUT TC 26, 0-26 mm (0-1")	0.370 kg	4	52005

#### ROCUT PS 35

Manual plastic pipe shear for cutting PP-, PE-, PEX-, PB- and PVDF pipes



Model	Weight	PU	No.
ROCUT PS 35, 6-35 mm (1/4-1.3/8")	0.740 kg	4	55005

#### ROCUT 26/42 S adjustable

Manual plastic pipe shear for cutting PP-, PE-, PEX-, PB- and PVDF pipes



Model	Weight	PU	No.
ROCUT 26/42 S, 6-42 mm (1/4-1.5/8")	0.950 kg	1	55015



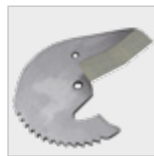
No. 55006



No. 52041



No. 52042



No. 52011



No. 52031



No. 52016



No. 1000003104

#### Accessories

	Weight	PU	No.
Spare blade for ROCUT 35 S, 6-35 mm (1/4-1.3/8")	0.030 kg	1	55006
Spare blade for ROCUT 32 S, 0-32 mm (0-1.1/4")	0.120 kg	1	52041
Spare blade for ROCUT TC 42, 0-42 mm (0-1.5/8")	0.120 kg	1	52042
Spare blade for ROCUT TC 50, 0-50 mm (0-2")	0.120 kg	1	52011
Spare blade for ROCUT TC 63, 0-63 mm (0-2.1/2")	0.130 kg	1	52031
Spare blade for ROCUT TC 75 Professional, 0-75 mm (0-3")	0.190 kg	6	52016
Spare blade for ROCUT 42 Twin Cut, 0-42 mm (0-1.5/8")	0.120 kg	1	1000003104

**ROCUT 110 set****Cutting and chamfering tool for right-angled cutting and chamfering (15°), Ø 32–110 mm**

Suitable for thin and thick-walled PVC, PE, PP, PEX, PB and PVDF pipes, as well as sound-insulated drain pipes. Utmost precision in a single operation.

**Application Benefits**

- Only one tool required for cutting, chamfering and deburring
- Extremely long service life with optimum cutting geometry
- Special accessories for PE, PP, PEX, PB and sound-insulated pipes
- Uniform chamfering of the entire pipe circumference
- Continuously adjustable pipe clamping pressure
- Integrated internal deburrer is stored in the handle
- Pipe cutting also possible without chamfering, as cutter blade shaft can be mounted with 180° offset

Set (No. 55035) includes: ROCUT 110 (No. 55020), internal deburrer (No. 55018), 2 × clamping set 50 and 75mm, cutter blade shaft with automatic copying and HM cutter blade inserts 7.5mm (No. 54960), ROCASE inlay (No. 1300005864), ROCASE 4414 red w/o inlay (No. 1300003541)

Model	Weight	PU	No.
ROCUT 110 set, 50, 75, 110 mm (2–4")	3.900 kg	1	55035

**RO  
CASE**

ROCUT 110 with cutter wheel  
(No. 54950) (special accessories)

**ROCUT 160 set****Cutting and chamfering tool for right-angled cutting and chamfering (15°), Ø 110–160 mm**

Suitable for thin and thick-walled PVC, PE, PP, PEX, PB and PVDF pipes, as well as sound-insulated drain pipes. Utmost precision in a single operation.

**Application Benefits**

- Only one tool required for cutting, chamfering and deburring
- Extremely long service life with optimum cutting geometry
- Special accessories for PE, PP, PEX, PB and sound-insulated pipes
- Uniform chamfering of the entire pipe circumference
- Continuously adjustable pipe clamping pressure
- Integrated internal deburrer is stored in the handle
- Pipe cutting also possible without chamfering, as cutter blade shaft can be mounted with 180° offset

Set (No. 55063) includes: ROCUT 160 (No. 55030), internal deburrer (No. 55018), 2 × clamping sets, cutter blade shaft with automatic copying and, HM cutter blade insert 12.5mm (No. 55019), ROCASE inlay (No. 1300005864), ROCASE 4414 red w/o inlay (No. 1300003541)

Model	Weight	PU	No.
ROCUT 160 set, 110, 125, 160 mm (4–6")	5.600 kg	1	55063

**RO  
CASE**

ROCUT 160 with cutter blade



### Clamping set ROCUT 110

**Basic unit Ø 32–110 mm**

For use with clamping sets Ø 32–100 mm, without internal deburrer, with standard cutter blade shaft and cutter blade

ROCUT 110 with cutter wheel  
(No. 54950) (special accessories)



Model	Weight	PU	No.
ROCUT 110, Basic unit, 32–110 mm	2.450 kg	1	55020
Clamping set for ROCUT 110, 32 mm, 2 semi-circular segments	0.330 kg	1	55026
Clamping set for ROCUT 110, 40 mm, 2 semi-circular segments	0.300 kg	1	55027
Clamping set for ROCUT 110, 50 mm, 2 semi-circular segments	0.290 kg	1	55025
Clamping set for ROCUT 110, 56 mm, 2 semi-circular segments	0.270 kg	1	55024
Clamping set for ROCUT 110, 63 mm, 2 semi-circular segments	0.220 kg	1	55023
Clamping set for ROCUT 110, 75 mm, 2 semi-circular segments	0.210 kg	1	55022
Clamping set for ROCUT 110, 80 mm, 2 semi-circular segments	0.170 kg	1	55047
Clamping set for ROCUT 110, 90 mm, 2 semi-circular segments	0.150 kg	1	55021
Clamping set for ROCUT 110, 100 mm	0.110 kg	1	55048

### Clamping set ROCUT 160

**Basic unit Ø 110–160 mm**

Cutter blade shaft with automatic copying and cutter blade, for use with clamping sets Ø 110–140 mm, without internal deburrer

ROCUT 160 with cutter blade



Model	Weight	PU	No.
ROCUT 160, Basic unit, 110–160 mm	3.450 kg	1	55030
Clamping set for ROCUT 160, 110 mm, 2 semi-circular segments	0.310 kg	1	55033
Clamping set for ROCUT 160, 125 mm, 2 semi-circular segments	0.250 kg	1	55032
Clamping set for ROCUT 160, 140 mm, 2 semi-circular segments	0.180 kg	1	55031

## HM-cutter clade inserts

### ROCUT 110 and ROCUT 160

Parting and chamfering system tool for right-angled, flat parting and chamfering

#### Application Benefits

- Accessory for ROCUT 110 / 160

#### Technical Data

Working area	Ø32–160 mm
Suitable for	PVDF, PVC, PP, PEX, PE, PB



No. 54960

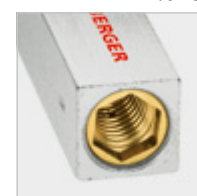


No. 54961

Model	Weight	PU	No.
Cutter blade shaft for ROCUT 110/160, 7.5 mm	0.111 kg	1	54960
Cutter blade shaft for ROCUT 110/160, 12.5 mm	0.120 kg	1	54961
Spare HM cutter blade 15°, 7.5 mm	0.010 kg	1	55029
Spare HM cutter blade 15°, 12.5 mm	0.020 kg	1	55019



With automatic copying



## Cutter wheels

### ROCUT 110 and ROCUT 160

Parting and chamfering system tool for right-angled, flat parting and chamfering

#### Application Benefits

- Accessory for ROCUT 110 / 160

#### Technical Data

Working area	Ø32–160 mm
Suitable for	PVDF, PVC, PP, PEX, PE, PB



No. 54950

Model	Weight	PU	No.
Cutter blade shaft with cutter wheel for ROCUT	0.130 kg	1	54950
Spare cutter wheel 2 pcs.	0.010 kg	1	055053D
Spare cutter wheel 3 pcs.	0.020 kg	1	055054D
Spare cutter wheel 2 pcs.	0.020 kg	1	055074D



No. 055053D



No. 055054D



No. 055074D

**PIPECUT mini**

The PIPECUT mini is a real all-rounder. It cuts copper, steel, stainless steel, plastic, multilayer composite pipes as well as profiles, mounting rails and threaded rods. The PIPECUT mini can be used stationary in the workshop and at the same time mobile on the construction site. The machine is powered by a CAS battery, which can be used to power 200 other machines from 20 different manufacturers.



1

For new installations and maintenance in the HVAC and industry sector

**Application Benefits**

- Copper, plastic, C-steel, cast iron or stainless steel can be reliably cut in an 90 degree angle up to a pipe diameter of 110mm
- Cut mounting rails or threaded bolts—easy and fast
- Transform the PIPECUT mini into a circular saw, into a plunge saw or into a cross-cutting saw
- Three new, high-quality saw blades
- Stationary and mobile use
- CAS battery system for maximum independence

**Technical Data**

Working area	Ø 0–110 mm (0–4")
System battery	CAS
Idle speed (min–max)	0–4.150/min
Sound pressure level	92 dB(A)
Sound power level (LwA)	103 dB(A)
Cutting depth	45 mm
Suitable for	Copper, MLP, steel, cast iron

**Powerful 18V battery**

Up to 140 cuts with just one battery charge (18V / 4.0 Ah, C-steel Ø42mm)

**Additional high quality, fire-resistant bag**

For absorbing shaving

**Extra contact surface with ball bearing**

For rotating and for cutting pipes over Ø 42 and up to 110mm

**Additional notch**

For cutting threaded bolts

**Brushless Motor**

For wear-free work and longer machine life

**Three new high quality saw blades**

For a precise cutting performance

**Convertible guide rail**

For using the PIPECUT mini as circular saw, plunge saw or cross-cutting saw



Copper, plastic, C-steel, cast iron or stainless steel can be cut up to a pipe diameter of 110mm.



Transform the PIPECUT mini into a circular saw, into a plunge saw or into a cross-cutting saw.

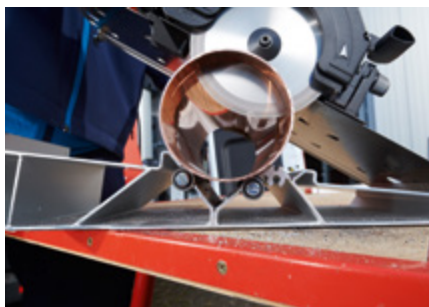


Clamp function enables fastest cutting performance for different materials.



## PIPECUT mini sets

All sets includes: PIPECUT mini baretool, DURACUT Uni saw blade, pipe support stand and ROCASE 6427 with inlay



Cross cut guide rail (No. 1500003694) for cutting plates optionally available



Set (No. 1000003165) includes: PIPECUT mini bare tool, cross cut guide rail (No. 1500003693), 1 × RO BP18/4, 4.0 Ah 18 V battery (No. 1000001653), RO BC14/36 charger, 230 V (No. 1000001654), instruction manual, ROCASE 6427

Model	Weight	PU	No.
PIPECUT mini bare tool with universal saw blade	5.400 kg	1	1000003374
PIPECUT mini inclusive battery charger, 1 × 4.0Ah battery	6.200 kg	1	1000003165
PIPECUT mini inclusive battery charger and cross cut guide rail, 1 × 4.0 Ah battery	6.800 kg	1	1000003398
DURACUT Uni, universal saw blade	0.100 kg	1	1500003621
DURACUT St, steel saw blade	0.100 kg	1	1500003673
DURACUT X, stainless steel saw blade	0.100 kg	1	1500003674
Cross cut guide rail for PIPECUT mini	0.400 kg	1	1500003694
Pipe support stand for PIPECUT mini	0.190 kg	1	1500003693

## Batteries and charger

Model	Weight	PU	No.
RO BP18/2, 2.0 Ah 18 V	0.420 kg	1	1000001652
RO BP18/4, 4.0 Ah 18 V	0.575 kg	1	1000001653
RO BP18/4, 4.0 Ah 18 V, Li-HD	0.515 kg	1	1000002548
RO BP18/8, 8.0 Ah 18 V, Li-HD	0.915 kg	1	1000002549
RO BC14/36 charger, 230 V	0.580 kg	1	1000001654

## Cutting

### Cutting metal and plastic / MLP, manual

#### ROBO SUPER

Suitable for sawing different materials

- Minimizes risks: safety handle with exact guidance
- Room for spare blades in holder
- Optimum saw blade tensioning: quick tensioning device with fine adjustment integrated in handle
- Ideal for cutting in confined spaces: 90° rotatable



Model	Weight	PU	No.
ROBO SUPER SW 300 with HSSE 4 Plus saw blade	0.680 kg	1	71206

#### Metal saw arch

- Solid design with robust holder
- With cross-slotted squared clamping elements
- Reliable captive blade holding pin
- Firm wooden handle

Cross-slotted squared clamping piece



Model	Weight	PU	No.
Metal saw frame without saw blade, 300 mm	0.530 kg	1	300013

#### Hand saw blade HSSE 4 PLUS

##### Bimetal hand saw blade

Highly flexible spring band steel with fused HSSE cutter

##### Application Benefits

- Highest flexibility with extremely hard teeth
- Hardness approx. 65 HRC: Average service life 4 times longer
- Risk of breakage significantly reduced even under extreme operational demands
- Precise cutting with individual tooth setting

#### ROBO MINI

Suitable for sawing different materials

- Handle with ergonomic form enables powerful sawing in tight spaces
- Large dimension tightening screw



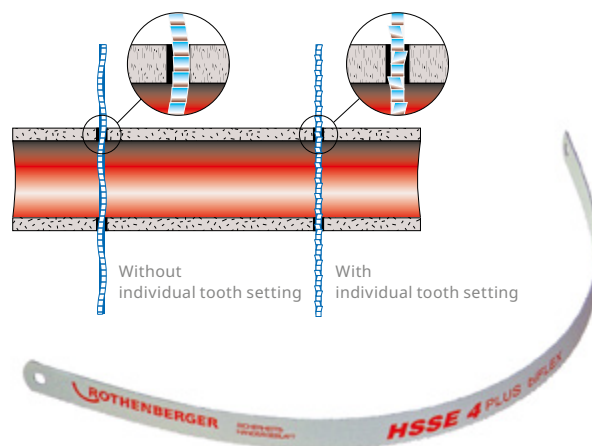
Model	Weight	PU	No.
Saw blade for PUK metal, 150 mm / 32 tpi	0.020 kg	12	71217

#### Saw blades for UNI small saw PUK

For sawing all materials, small and handy, good cutting performance



Model	Weight	PU	No.
Saw blade for PUK 150 mm / 14 ZpZ	0.020 kg	12	71216
Saw blade for PUK saw metal, 150 mm / 32 tpi	0.020 kg	12	71217



Model	Weight	PU	No.
HSSE 4 Plus bimetal, 300 mm	0.020 kg	100	71213

Hand saw blades with single offset teeth optimally cut the hand saw blade free. Jamming in the workpiece is prevented. Therefore, the working rhythm is maintained, less effort is needed and there is a higher cutting performance.



## Universal internal and external Deburrer

### Quick and easy deburring $\varnothing 4-54$ mm (1/8-2")

For copper, steel and stainless steel pipes, with polished cutting blade made of hardened special steel; smooth running

#### Application Benefits

- Time saving: Inner and outer deburring allows you to work more efficiently when installing pipes
- Energy saving: Ergonomic design ensures accurate and burr-free deburring without much effort



No. 11006



No. 150000237



No. 150000236

Model	Weight	PU	No.
Internal and external deburrer, 6-35 mm (1/4-1.3/8")	0.100 kg	1	150000237
Internal and external deburrer INOX, 10-54 mm (3/8-2")	0.390 kg	1	150000236
Internal and external deburrer Cu, MPL, 4-36 mm (1/8-1.3/8")	0.030 kg	1	11006

## Deburring adapter

Adaptor for the use of the internal and external deburring with portable screwdriver or drill

#### Application Benefits

- User-friendly solution for deburring pipes internal and external
- Saves time
- Precise, burr-free deburring without effort

Best deburring results at low speed, 800 rpm at the most!



Drive shaft

For the deburring with portable screwdriver or drill

Model	Weight	PU	No.
Deburrer adaptor I for 150000237	0.160 kg	1	11044
Deburrer adaptor II for 150000236	0.280 kg	1	11045



## Cutting

### Deburring, chamfering and calibration

#### GRATFIX HSS

For deburring edges and pipes, as well as steel, aluminium, brass, copper, cast-iron and plastic plates

##### Application Benefits

- Replaceable blades
- GRATFIX with plastic cartridge grip
- Grip recess is raised at the end and prevents the tool from slipping out of users' hands

- One-handed use with the retractable locking head
- Offset surfaces provide a good torque
- Pluggable handle ends for the storage of associated blades

**Ideal for deburring of edges, pipes and steel, aluminium, brass, copper sheets, cast iron and plastic plates!**



##### Model

GRATFIX HSS with spare blade number 1, Universal

##### Weight

0.050 kg

##### PU

1

##### No.

21655

#### UNIGRAT

For deburring edges and pipes, as well as steel, aluminium, brass, copper, cast-iron and plastic plates

##### Application Benefits

- Replaceable blades
- UNIGRAT with plastic cartridge grip
- Grip recess is raised at the end and prevents the tool from slipping out of users hands

- One-handed use with the retractable locking head
- Offset surfaces provide a good torque
- Pluggable handle ends for the storage of associated blades

**Ideal for deburring of edges, pipes and steel, aluminium, brass, copper sheets, cast iron and plastic plates!**



##### Model

UNIGRAT with HSS deburring blade

##### Weight

0.030 kg

##### PU

10

##### No.

21660

### ROGRAT-MLP deburrer and chamfering tool

For internal and external deburring, chamfering, calibrating and custom milling of PE-X and aluminium multi-layer (MLP) pipes of up to Ø 16-26 mm



#### Application Benefits

- Internal and external deburrer for PE-X and aluminium multilayer pipes (MLP) through chamfering to approved standards
- Simultaneous chamfering
- Calibration of the pipe ends through a special guiding pin

One tool with three functions: chamfering, calibrating and deburring!

#### True to size guiding and calibration pin

Increased safety, protects O-ring from damage

#### Star handle with screw-bit attachment and quick locking mechanism

High force transmission



#### Shock-resistant protective sleeve

Protects from injury



Fig. ROGRAT MLP deburrer set

#### Color coding prevents confusion



#### System optimised chamfer



### ROGRAT MLP system-manual chamfering attachments

Model	Weight	PU	No.
Attachment for ROGRAT MLP, TH 16 mm	0.053 kg	1	14122
Attachment for ROGRAT MLP, TH 26 mm	0.108 kg	1	14126

Set includes: carrying case (No. 14005), with basic handle grip (No. 14000) and system-manual chamfering attachments

Model	Weight	PU	No.
ROGRAT MSR-Set TH 16, 20, 26 mm	0.760 kg	1	14250
Basic handle for ROGRAT	0.250 kg	1	14000



## Core drilling



<b>System overview</b>	46-47
<b>Dry drilling</b>	
Characteristics dry drill bits	48
Dry drilling machine	49
Dry drill bits	50-53
<b>Wet and dry drilling</b>	
Characteristics diamond drill bits	54
Wet drilling machine	55
Diamond wet and dry drilling systems	56-60
<b>Diamond drill bits</b>	
Wet cutting drill bits for natural stone, soldered	61
Wet and dry cutting drill bits, space welding	62-65
<b>Accessories hand-operated and stationary drilling</b>	
Vacuum pump systems	66
Accessories diamond core drilling	66-68
<b>Extraction systems</b>	
Wet and dry extraction unit	69

**Hand-operated drilling**

**RODIADRILL 1800 Dry**

**RODIADRILL Ceramic**

**RODIADRILL 160**

**RODIADRILL 200**



Stationary drilling: Concrete	Ø 32–202 mm	Ø 6–67 mm	Ø 10–132 mm	Ø 10–200 mm
Stationary drilling: Masonry	Ø 32–202 mm	Ø 6–67 mm	Ø 32–162 mm	Ø 32–225 mm
Hand-operated drilling: Concrete	Ø 32–92 mm	Ø 6–35 mm	Ø 10–82 mm	Ø 10–82 mm
Hand-operated drilling: Masonry	Ø 32–92 mm	Ø 6–67 mm	Ø 32–162 mm	Ø 32–250 mm
Power	1,800 W	800 W	1,400 W	2,200 W
Speed transmission	1-gear	2-gear	2-gear	3-gear
Nominal speed	1,800 rpm	3,600 / 6,400 rpm	500 / 1,050 rpm	600 / 1,250 / 3,200 rpm
Torque	20 Nm	4 / 7 Nm	55 / 27 Nm	71 / 34 / 17 Nm
Weight	5.500 kg	3.400 kg	6.700 kg	7.200 kg
<b>Page</b>	<b>49</b>	<b>55</b>	<b>57</b>	<b>57</b>

**Drill bits**

**DX High Speed Dry**

**High Speed Plus natural stone**

**DX High Speed Plus**

**SPEED STAR DX**





Connection	G 1/2", 1.1/4" UNC	G 1/2"	G 1/2", 1.1/4" UNC	G 1/2", 1.1/4" UNC
Drill bit diameter	Ø 32–205 mm	Ø 6–67 mm	Ø 20–300 mm	Ø 10–500 mm
Working length	G 1/2" & 1.1/4" UNC 150 mm and 330 mm	up to Ø 10 mm = 50 mm from Ø 12 mm = 120 mm	G 1/2", 400 mm length 1.1/4" UNC, 430 mm length	G 1/2", 400 mm length 1.1/4" UNC, 430 mm length
Application	dry	wet	wet and dry	wet and dry
Tiles	✓	✓✓✓	✓	✓✓
Granite	✓	✓✓✓	✓	✓✓
Marble	✓	✓✓✓	✓	✓✓
Brick	✓✓✓	✓✓	✓✓✓✓	✓✓✓✓
Masonry	✓✓✓	✓	✓✓✓✓	✓✓✓
Lime-sand brick	✓✓✓	✓	✓✓✓✓	✓✓✓
Asphalt	✓✓✓	✓✓	✓✓✓✓	✓✓✓✓
Screed	✓✓✓	✓✓	✓✓✓	✓✓
Concrete	✓✓✓	✓✓✓	✓✓✓	✓✓
Reinforced concrete	✓✓✓	✓✓✓	✓✓	✓✓✓
<b>Page</b>	<b>50</b>	<b>61</b>	<b>62</b>	<b>64</b>

✓✓✓ = Ideally suited for dry drilling  
 ✓✓ = Very suitable dry drilling  
 ✓ = Suitable for dry drilling

✓✓✓ = Ideally suited for wet drilling  
 ✓✓ = Very suitable wet drilling  
 ✓ = Suitable for wet drilling

Hand-operated drilling		Stationary drilling		
RODIADRILL 500		RODIACUT 150 RODIADRILL 160	RODIACUT 150 RODIADRILL 200	RODIACUT 250 RODIADRILL 200
				
Stationary drilling: Concrete	Ø 32-400 (500 <sup>2</sup> ) mm	Ø 10-132 mm	Ø 10-152 mm	Ø 10-200 mm
Stationary drilling: Masonry	Ø 32-400 (500 <sup>2</sup> ) mm	Ø 10-152 mm	Ø 10-152 mm	Ø 32-225 mm
Hand-operated drilling: Concrete	○	Ø 10-82 mm	Ø 10-82 mm	Ø 10-82 mm
Hand-operated drilling: Masonry	○	Ø 32-162 mm	Ø 32-250 mm	Ø 32-250 mm
Power	3,000 W	1,400 W	2,200 W	2,200 W
Speed transmission	3-gear	2-gear	3-gear	3-gear
Nominal speed	215 / 430 / 785 rpm	500 / 1,050 rpm	600 / 1,250 / 3,200 rpm	600 / 1,250 / 3,200 rpm
Torque	185 / 107 / 55 Nm	55 / 27 Nm	71 / 34 / 17 Nm	71 / 34 / 17 Nm
Weight	12.100 kg	16.700 kg	17.200 kg	25.200 kg
<b>Page</b>	<b>59</b>	<b>56</b>	<b>56</b>	<b>58</b>

Stationary drilling		
	RODIACUT 250 RODIADRILL 500	RODIACUT 400 PRO RODIADRILL 500
 		
Stationary drilling: Concrete	Ø 32-250 mm	Ø 32-400 (500 <sup>2</sup> ) mm
Stationary drilling: Masonry	Ø 32-250 mm	Ø 32-400 (500 <sup>2</sup> ) mm
Hand-operated drilling: Concrete	○	○
Hand-operated drilling: Masonry	○	○
Power	3,000 W	3,000 W
Speed transmission	3-gear	3-gear
Nominal speed	215 / 430 / 785 rpm	215 / 430 / 785 rpm
Torque	185 / 107 / 55 Nm	185 / 107 / 55 Nm
Weight	30.100 kg	39.800 kg
<b>Page</b>	<b>58</b>	<b>60</b>

2) Drilling range with distance plate expandable up to 500 mm

## Core drilling

### Dry drill bits

#### Dry drill bits: DX High Speed Dry

##### Uncomplicated and universally applicable

- Dry drilling causes less dirt and no wetness
- No water supply needed at the job site
- Uncomplicated preparation and follow-up saves time and effort
- Trouble-free drilling in reinforced concrete, masonry or sand-lime brick
- There is a suitable variant for every application: Threaded sockets 1.1/4" UNC and G1/2" Working length 150 & 330 mm Diameter 32-205 mm



##### Segment height: 10 mm

High cutting performance and long service life

##### Precise, three-dimensional symmetry of the diamond segments

Even wear—less effort when drilling

##### Overwound drill bits

Balanced rotation reduces wear

For more information and videos follow us on Youtube



#### DX High Speed Dry

Dry drill bits with 3D-Diamatrix segments



#### Application Benefits

- 3D diamond matrix: Three-dimensional positioning of the diamonds for easy-cutting drilling, even wear of the segments, little effort and long service life
- Segment height: 10 mm, for high cutting efficiency and long service life
- Overturned drill bits ensure precise concentricity and reduce wear and tear
- Air vents eliminate drilling dust and provide cooling
- 1.1/4" UNC and 1/2" threaded mounting is suitable for all ROTHENBERGER drill motors
- Working length 150 & 330 mm
- Available in diameters 32-205 mm

#### Accessories



No. FF40185



No. 1000003978

Description	Page	No.
Drill Motor RODIADRILL 1800 DRY	49	FF40185
RODIA DW CLEANER M	69	1000003978

Dry drill bits DX High Speed Dry on page 50



## RODIADRILL 1800 DRY

The electrical drill motor RODIADRILL 1800 DRY is suited for hand-operated and stationary drillings from Ø 32 to 202 mm



### Application Benefits

- Efficient drilling due to additional POWER PULS technology
- Optimum drilling process due to stronger suction, removable extraction rotor for stationary core drilling
- Electronic friction clutch with 20 Nm torque for larger drill holes
- Safety due to electronic soft starter with overload indicator
- Easy handling and compact design, can be used close to the wall

### Technical Data

Input power	2,500 W
Output power	1,800 W
Power with unit of measurement	1,800 W
Current type	8.5 A
Drilling range	32–202 mm

2



Model	Weight	PU	No.
Drill Motor RODIADRILL 1800 DRY	5.500 kg	1	FF40185

## DX High Speed Dry

Dry drill bits with 3D-Diamatrix segments for easy-cutting and fast drilling



### Application Benefits

- 3D diamond matrix: Three-dimensional positioning of the diamonds for a cutting-friendly and long-lasting service life
- Very easy to drill for safe first cut in freehand operation
- Exact concentricity reduces wear

### Technical Data

Drill bits	Segments
Ø 32–92 mm	3–5
Ø 102–127 mm	6–7
Ø 132–162 mm	8–9
Ø 182–205 mm	10

2

#### Segment height: 10 mm

High cutting performance and long service life

#### Overwound drill bits

Balanced rotation reduces wear

#### 1.1/4" UNC and 1/2" threaded adaptor

Suitable for all other ROTHENBERGER drill motors

#### 3D-Diamatrix

The diamonds of the drill bit are three-dimensional and symmetrically arranged

#### Air vents

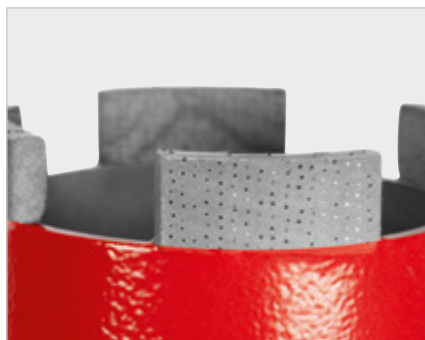
Remove drilling dust and provide cooling



Threaded adaptor 1.1/4" UNC with a large exhaust opening



3D-Diamatrix increase the service life and ensures less effort



Air vents for removal of the drill dust and for cooling work



## DX High Speed Dry 1.1/4" UNC



2

Model	Weight	PU	No.
DX High Speed Dry 1.1/4" UNC, D = 32 mm, NL = 330 mm	1.070 kg	1	1500004051
DX High Speed Dry 1.1/4" UNC, D = 37 mm, NL = 330 mm	1.170 kg	1	1500004054
DX High Speed Dry 1.1/4" UNC, D = 42 mm, NL = 330 mm	1.270 kg	1	1500004055
DX High Speed Dry 1.1/4" UNC, D = 52 mm, NL = 330 mm	1.473 kg	1	1500004056
DX High Speed Dry 1.1/4" UNC, D = 57 mm, NL = 330 mm	1.580 kg	1	1500004057
DX High Speed Dry 1.1/4" UNC, D = 62 mm, NL = 330 mm	1.680 kg	1	1500004058
DX High Speed Dry 1.1/4" UNC, D = 68 mm, NL = 330 mm	1.810 kg	1	1500004059
DX High Speed Dry 1.1/4" UNC, D = 72 mm, NL = 330 mm	1.910 kg	1	1500004060
DX High Speed Dry 1.1/4" UNC, D = 82 mm, NL = 330 mm	2.130 kg	1	1500004061
DX High Speed Dry 1.1/4" UNC, D = 92 mm, NL = 330 mm	2.360 kg	1	1500004062
DX High Speed Dry 1.1/4" UNC, D = 102 mm, NL = 330 mm	2.610 kg	1	1500004100
DX High Speed Dry 1.1/4" UNC, D = 107 mm, NL = 330 mm	2.730 kg	1	1500004063
DX High Speed Dry 1.1/4" UNC, D = 112 mm, NL = 330 mm	2.860 kg	1	1500004064
DX High Speed Dry 1.1/4" UNC, D = 122 mm, NL = 330 mm	3.120 kg	1	1500004065
DX High Speed Dry 1.1/4" UNC, D = 127 mm, NL = 330 mm	3.940 kg	1	1500004066
DX High Speed Dry 1.1/4" UNC, D = 132 mm, NL = 330 mm	4.110 kg	1	1500004067
DX High Speed Dry 1.1/4" UNC, D = 142 mm, NL = 330 mm	4.460 kg	1	1500004068
DX High Speed Dry 1.1/4" UNC, D = 152 mm, NL = 330 mm	4.810 kg	1	1500004069
DX High Speed Dry 1.1/4" UNC, D = 162 mm, NL = 330 mm	5.180 kg	1	1500004070
DX High Speed Dry 1.1/4" UNC, D = 182 mm, NL = 330 mm	5.930 kg	1	1500004071
DX High Speed Dry 1.1/4" UNC, D = 205 mm, NL = 330 mm	6.850 kg	1	1500004072

**DX High Speed Dry 1/2"**



2

Model	Weight	PU	No.
DX High Speed Dry 1/2", D=32 mm, NL=150 mm	0.590 kg	1	1500004078
DX High Speed Dry 1/2", D=37 mm, NL=150 mm	0.620 kg	1	1500004080
DX High Speed Dry 1/2", D=42 mm, NL=150 mm	0.660 kg	1	1500004081
DX High Speed Dry 1/2", D=52 mm, NL=150 mm	0.750 kg	1	1500004082
DX High Speed Dry 1/2", D=57 mm, NL=150 mm	0.790 kg	1	1500004083
DX High Speed Dry 1/2", D=62 mm, NL=150 mm	0.830 kg	1	1500004084
DX High Speed Dry 1/2", D=68 mm, NL=150 mm	0.880 kg	1	1500004085
DX High Speed Dry 1/2", D=72 mm, NL=150 mm	0.930 kg	1	1500004086
DX High Speed Dry 1/2", D=82 mm, NL=150 mm	1.030 kg	1	1500004087
DX High Speed Dry 1/2", D=92 mm, NL=150 mm	1.130 kg	1	1500004088
DX High Speed Dry 1/2", D=102 mm, NL=150 mm	1.240 kg	1	1500004089
DX High Speed Dry 1/2", D=107 mm, NL=150 mm	1.300 kg	1	1500004090
DX High Speed Dry 1/2", D=112 mm, NL=150 mm	1.360 kg	1	1500004091
DX High Speed Dry 1/2", D=122 mm, NL=150 mm	1.490 kg	1	1500004092
DX High Speed Dry 1/2", D=127 mm, NL=150 mm	1.840 kg	1	1500004093
DX High Speed Dry 1/2", D=132 mm, NL=150 mm	1.930 kg	1	1500004094
DX High Speed Dry 1/2", D=142 mm, NL=150 mm	2.090 kg	1	1500004095
DX High Speed Dry 1/2", D=152 mm, NL=150 mm	2.270 kg	1	1500004096
DX High Speed Dry 1/2", D=162 mm, NL=150 mm	2.450 kg	1	1500004097
DX High Speed Dry 1/2", D=182 mm, NL=150 mm	2.830 kg	1	1500004098
DX High Speed Dry 1/2", D=205 mm, NL=150 mm	3.270 kg	1	1500004099
DX High Speed Dry 1/2", D=32 mm, NL=330 mm	0.760 kg	1	1500004074
DX High Speed Dry 1/2", D=37 mm, NL=330 mm	0.830 kg	1	1500004075
DX High Speed Dry 1/2", D=42 mm, NL=330 mm	0.900 kg	1	1500004076
DX High Speed Dry 1/2", D=52 mm, NL=330 mm	1.040 kg	1	1500004077

## DX High Speed Dry M16



2

Model	Weight	PU	No.
DX High Speed Dry M16, D = 32 mm, NL = 150 mm	1.070 kg	1	1500004163
DX High Speed Dry M16, D = 37 mm, NL = 150 mm	0.620 kg	1	1500004165
DX High Speed Dry M16, D = 42 mm, NL = 150 mm	0.660 kg	1	1500004167
DX High Speed Dry M16, D = 52 mm, NL = 150 mm	0.750 kg	1	1500004168
DX High Speed Dry M16, D = 57 mm, NL = 150 mm	0.790 kg	1	1500004170
DX High Speed Dry M16, D = 62 mm, NL = 150 mm	0.830 kg	1	1500004171
DX High Speed Dry M16, D = 68 mm, NL = 150 mm	0.880 kg	1	1500004172
DX High Speed Dry M16, D = 72 mm, NL = 150 mm	0.930 kg	1	1500004173
DX High Speed Dry M16, D = 82 mm, NL = 150 mm	1.030 kg	1	1500004174
DX High Speed Dry M16, D = 92 mm, NL = 150 mm	1.130 kg	1	1500004175
DX High Speed Dry M16, D = 102 mm, NL = 150 mm	1.240 kg	1	1500004176
DX High Speed Dry M16, D = 107 mm, NL = 150 mm	1.300 kg	1	1500004177
DX High Speed Dry M16, D = 112 mm, NL = 150 mm	1.360 kg	1	1500004179
DX High Speed Dry M16, D = 122 mm, NL = 150 mm	1.490 kg	1	1500004180
DX High Speed Dry M16, D = 127 mm, NL = 150 mm	1.840 kg	1	1500004181
DX High Speed Dry M16, D = 132 mm, NL = 150 mm	1.930 kg	1	1500004182
DX High Speed Dry M16, D = 142 mm, NL = 150 mm	2.090 kg	1	1500004183
DX High Speed Dry M16, D = 152 mm, NL = 150 mm	2.270 kg	1	1500004184
DX High Speed Dry M16, D = 162 mm, NL = 150 mm	2.450 kg	1	1500004185
DX High Speed Dry M16, D = 182 mm, NL = 150 mm	2.830 kg	1	1500004186
DX High Speed Dry M16, D = 205 mm, NL = 150 mm	3.270 kg	1	1500004187

**Space welding**

Cold welding process according to cutting-edge bonding technology: Due to the “neutral zone” the entire diamond segment is used without waste.

**Space welding**

Wet and dry drilling with new technology:

- The innovative high-performance drill bit DURAMANT PRO and SPEED STAR DX is produced using cutting-edge welding technology
- Because of the neutral zone, the “Space welding” cold welding process guarantees the optimum use of the complete diamond segments without loss
- The service life is up to 20% higher compared to lasered and soldered drill bits

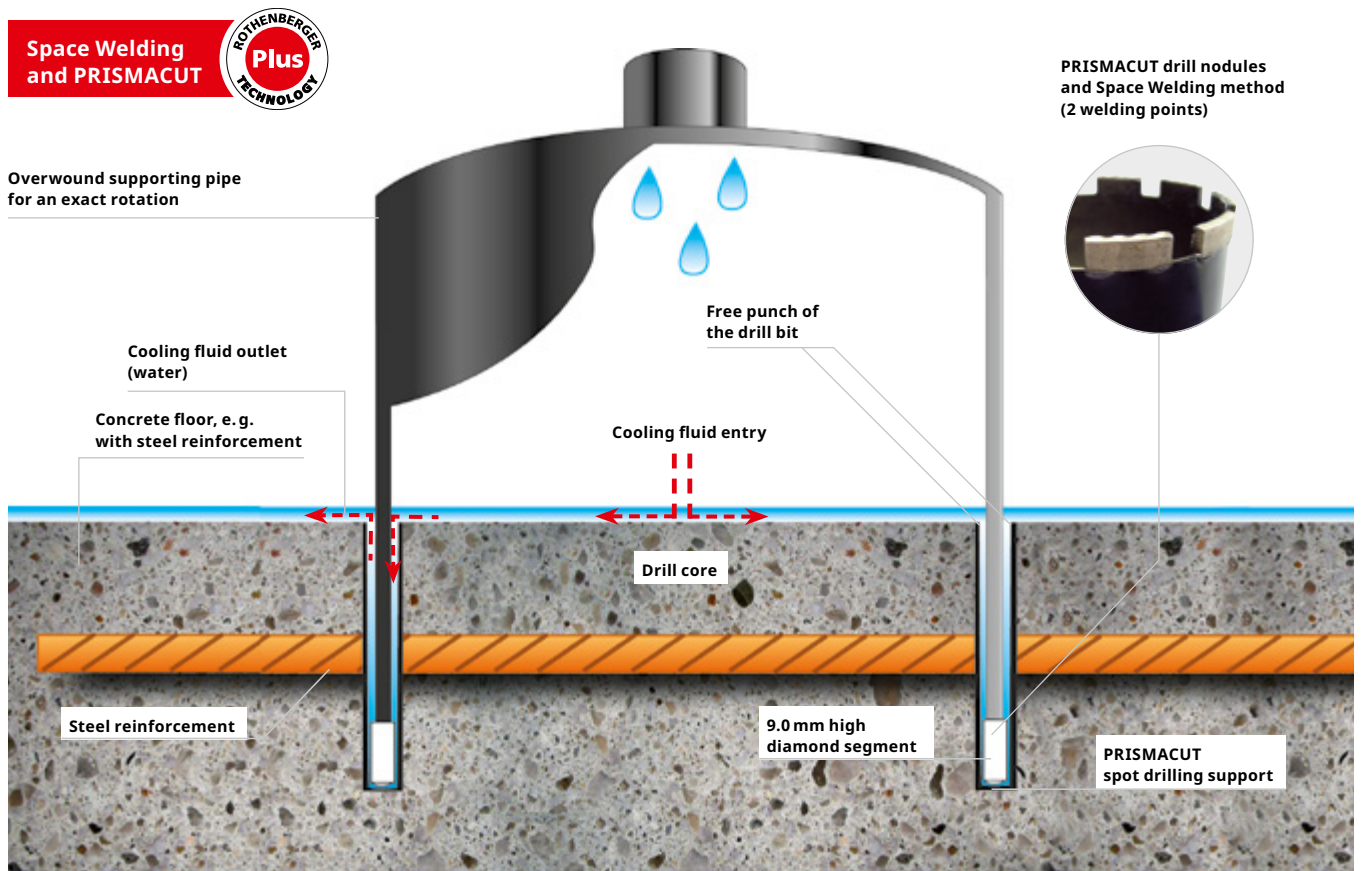
**PRISMACUT**

Four drill nodules on the diamond segment improve the drill behaviour and at the same time provides optimum water cooling.

**PRISMACUT**

- The exceptional segment positioning offers optimum free punch size and an excellent cutting speed
- The “PRISMACUT” centre drill nodule is characterised by a better drill behaviour and preservation of the diamond segment
- PRISMACUT guarantees direct water cooling of the diamond segments
- 15% higher cutting speed with steel reinforcement

2



**DX High Speed Plus universal drill bits**

Space welding universal wet and dry drill bits for Ø 10–300 mm

**SPEED STAR DX**

Space welding wet and dry drill bits for different diameters in the range of 10–500 mm



**DX-High Speed Plus universal drill bits on page 62**

**SPEED STAR DX drill bits on page 64**

## RODIADRILL Ceramic

### Hand-operated wet drilling, drill Ø 6–67 mm

Ideally suited for HVAC&R, plumbing professionals, tilers, stair builders, remodelling specialists as well as electricians. Everywhere where jolt-free operation is necessary and extremely hard materials need to be processed

#### Hand-operated wet drilling in:

(reinforced) concrete Ø 6–35 mm, marble, granite, ceramic tiles, masonry, hollow brickwork and glass Ø 6–67 mm

#### Application Benefits

- For all common G 1/2" drill bits
- Fatigue-free operation with the lightweight
- Also drills through material combinations (for example tiles + masonry) without damaging material or surfaces and without cumbersome tool change
- "Aqua-stop button" with quantity adjustment
- Ideal for serial drilling with the external water supply
- Toolless exchange of the drill bits with the Quick change system
- Integrated 1 litre water tank for 4–6 drill holes

#### Integrated 1 litre water tank

Sufficient supply for 4–6 drill holes and can be rotated when working in confined spaces

#### Quick change system drill bit adaptor

Toolless quick change for G 1/2" drill bits

#### Connection for external water supply

Ideal solution for serial drillings

11-part set (No. FF40150) includes: drill motor RODIADRILL Ceramic (No. FF40150), 1 high speed plus drill bit each Ø 6–8–10 mm (No. FF44806, FF44808, FF44810), 3 × quick change adapter (No. FF35751), spanners sizes 24 and 27 (No. FF70024, FF70027), hexagonal key (No. 321523), ROCASE 6414 (No. 1300003336), ROCASE inlay (No. 1300005582)

#### Model

RODIADRILL Ceramic Set Drill bits 6–8–10 mm, 230 V

#### Weight

3.400 kg

#### PU

1

#### No.

FF40150



No. FF3571



No. FF35028



No. FF35301



No. FF35302



High Speed Plus Natural Stone



No. FF35700

#### Accessories

#### Page

#### No.

Quick change adaptor		FF35751
Pressurized water container 10l	67	FF35028
Special water supply hose	67	FF35301

#### Accessories

#### Page

#### No.

Water supply hose with "aqua-stop"	67	FF35302
HSP Nature stone drill bits	61	
Water collecting ring, stationary	68	FF35700



#### Technical Data

Input power	1,150 W
Voltage	230 V
Output power	800 W
Speed	3,600 rpm
Speed 2-gear	6,400 rpm
Number of courses	2
Drilling area concrete	35 mm
Drilling area masonry	67 mm
Power	230 V
Current type	3.6 A



"Aqua-stop button"—water pressure valve with quantity adjustment

Perfectly regulated flow of the water quantity

**RODIACUT 150 / RODIADRILL 160**

**RODIACUT 150 drill stand with combination drill mounting plate and RODIADRILL 160 drill motor for drilling Ø 10-132 mm (Ø 162 mm) in reinforced concrete**



**RODIADRILL 160:**

Ø 10-132 mm for stationary wet drilling in (reinforced) concrete,  
 Ø 10-82 mm for hand-operated wet drilling in (reinforced) concrete,  
 Ø 10-162 mm for hand-operated dry drilling in masonry

**Application Benefits**

- Drill angle adjustments from 0° up to +45°, in 15° steps adjustable
- One tool for all settings on the drill stand
- 2 leveling indicators included 4 adjustment screws for fast and precise alignment of the drill stand
- Lightweight aluminum construction allows a one man operation of the drilling system
- Fully-equipped drill stand including Borehole centre indicator, drill depth stop and a scale for easier application

**Technical Data**

Input power	2,000 W
Output power	1,400 W
Speed	1,570 rpm
Drilling stroke	430 mm
Drilling area concrete	132 mm
Drilling area masonry	162 mm

**3 applications with one device!**



Model	Weight	PU	No.
RODIACUT 150 / RODIADRILL 160	16.500 kg	1	FF34150
RODIACUT 150	9.700 kg	1	FF30150
RODIADRILL 160	6.800 kg	1	FF40165

**RODIACUT 150 / RODIADRILL 200**

**RODIACUT 150 drill stand with combination drill mounting plate and RODIADRILL 200 drill motor for drilling Ø 10-132 mm (Ø 162 mm) in reinforced concrete**



**RODIADRILL 200:**

Ø 10-132 mm for stationary wet drilling in (reinforced) concrete,  
 Ø 10-82 mm for hand-operated wet drilling in (reinforced) concrete,  
 Ø 10-162 mm for hand-operated dry drilling in masonry

**Application Benefits**

- Drill angle adjustments from 0° up to +45°, in 15° steps adjustable
- One tool for all settings on the drill stand
- 2 leveling indicators included 4 adjustment screws for fast and precise alignment of the drill stand
- Lightweight aluminum construction allows a one man operation of the drilling system
- Fully-equipped drill stand including Borehole centre indicator, drill depth stop and a scale for easier application

**Technical Data**

Input power	2,700 W
Output power	2,200 W
Speed	3,200 rpm
Drilling stroke	430 mm
Drilling area concrete	132 mm
Drilling area masonry	162 mm

**3 applications with one device!**



Model	Weight	PU	No.
RODIACUT 150 / RODIADRILL 200	16.900 kg	1	FF34160
RODIACUT 150	9.700 kg	1	FF30150
RODIADRILL 200	7.200 kg	1	FF40220



**RODIADRILL 160****Drill motor****RODIADRILL 160:**

Ø 10–132 mm for stationary wet drilling in (reinforced) concrete,  
 Ø 10–82 mm for hand-operated wet drilling in (reinforced) concrete,  
 Ø 10–162 mm for hand-operated dry drilling in masonry

**Application Benefits**

- Safety for motor and user through integrated mechanical sliding clutch, electronically controlled overload cut-off and PRCD circuit breaker
- Optimum drilling progress through electronically controlled soft start and LED display
- In the event of overload cut-off the motor is immediately ready after restarting
- Low operating costs due to maintenance-friendly head

Model	Weight	PU	No.
RODIADRILL 160	6.800 kg	1	FF40165

**Technical Data**

Input power	2,000 W
Output power	1,400 W
Speed	1,570 rpm

**RODIADRILL 200****Drill motor****RODIADRILL 200:**

Ø 10–200 mm for stationary wet drilling in reinforced concrete,  
 Ø 10–225 mm for stationary dry drilling in masonry,  
 Ø 10–82 mm for hand-operated wet drilling in reinforced concrete,  
 Ø 10–250 mm for hand-operated dry drilling in masonry

**Application Benefits**

- Safety for motor and user through integrated mechanical sliding clutch, electronically controlled overload cut-off and PRCD circuit breaker
- Optimum drilling progress through electronically controlled soft start and LED display
- In the event of overload cut-off the motor is immediately ready after restarting
- Low operating costs due to maintenance-friendly head

Model	Weight	PU	No.
RODIADRILL 200	7.200 kg	1	FF40220

**Technical Data**

Input power	2,700 W
Output power	2,200 W
Speed	3,200 U/min



No. FF40150



No. 1000003978



No. FF35028



No. FF35700



No. FF35200



No. FF40056



SPEED STAR DX



DX High Speed Plus

Accessories	Page	No.
RODIADRILL Ceramic	55	FF40150
Pressurized water container 10l	67	FF35028
Vacuum pump RODIA-VAC	66	FF35200

Accessories	Page	No.
RODIA DW CLEANER M	69	1000003978
Water collecting ring, stationary	68	FF35700
Drill bits	61–65	

**RODIACUT 250 / RODIADRILL 200**

**RODIACUT 250 drill stand with combination drill mounting plate and RODIADRILL 200 drill motor for drilling Ø 10-200 mm (Ø 250 mm) in reinforced concrete**

**RODIADRILL 200:**

Ø 10-200 mm for stationary wet drilling in reinforced concrete,  
 Ø 10-225 mm for stationary dry drilling in masonry,  
 Ø 10-82 mm for hand-operated wet drilling in reinforced concrete,  
 Ø 10-250 mm for hand-operated dry drilling in masonry



**Technical Data**

Input power	2,700 W
Output power	2,000 W
Speed	3,200 rpm
Drilling stroke	430 mm
Drilling area concrete	200 mm
Drilling area masonry	200 mm

**Application Benefits**

- Drill angle adjustments from 0° up to +45°, in 15° steps adjustable
- One tool for all settings on the drill stand
- 2 leveling indicators included 4 adjustment screws for fast and precise alignment of the drill stand
- Lightweight aluminum construction allows a one man operation of the drilling system
- Fully-equipped drill stand including Borehole centre indicator, drill depth stop and a scale for easier application

**4 applications with one device!**



**Hexagon socket screw key 6 mm included**

All adjustments with a single tool

**Buckling resistant column**

Robust and lightweight

**Adjustable handle**

Quick change of operating side-drilling, even in confined spaces

Model	Weight	PU	No.
RODIACUT 250 / RODIADRILL 200	26.600 kg	1	FF34200
RODIACUT 250	14.500 kg	1	FF30250
RODIADRILL 200	7.200 kg	1	FF40220

**RODIACUT 250 / RODIADRILL 500**

**RODIACUT 250 drill stand with combination drill mounting plate and RODIADRILL 500 drill motor for drilling Ø 32-250 mm in reinforced concrete**

**RODIADRILL 500:**

Ø 32-250 mm for stationary wet drilling in reinforced concrete,  
 Ø 32-250 mm for stationary dry drilling in masonry



**2 applications with one device!**



**Application Benefits**

- Drill angle adjustments from 0° up to +45°, in 15° steps adjustable
- One tool for all settings on the drill stand
- 2 leveling indicators included 4 adjustment screws for fast and precise alignment of the drill stand
- Lightweight aluminum construction allows a one man operation of the drilling system
- Fully-equipped drill stand including Borehole centre indicator, drill depth stop and a scale for easier application

Model	Weight	PU	No.
RODIACUT 250 / RODIADRILL 500	31.400 kg	1	FF34260
RODIACUT 250	14.500 kg	1	FF30250
RODIADRILL 500	12.100 kg	1	FF40400

**RODIADRILL 200****Drill motor****RODIADRILL 200:**

Ø 10–200 mm for stationary wet drilling in reinforced concrete,  
 Ø 10–225 mm for stationary dry drilling in masonry,  
 Ø 10–82 mm for hand-operated wet drilling in reinforced concrete,  
 Ø 10–250 mm for hand-operated dry drilling in masonry

**Application Benefits**

- Safety for motor and user through integrated mechanical sliding clutch, electronically controlled overload cut-off and PRCD circuit breaker
- Optimum drilling progress through electronically controlled soft start and LED display
- In the event of overload cut-off the motor is immediately ready after restarting
- Low operating costs due to maintenance-friendly head



2

Model	Weight	PU	No.
RODIADRILL 200	7.200 kg	1	FF40220

**Technical Data**

Input power	2,700 W
Output power	2,200 W
Speed	3,200 U/min

**RODIADRILL 500****Drill motor****RODIADRILL 500**

Ø 32–400 mm for stationary wet drilling in concrete,  
 Ø 32–400 mm for stationary dry drilling in masonry

**Application Benefits**

- Safety for motor and user due to integrated mechanical slipping clutch, electronically controlled overload cut-off and PRCD switch
- Optimum drilling progress due to electronically controlled soft start and LED display
- In the event of overload shutdown, the motor is immediately ready for use again after restarting
- Low operating costs due to easy-to-maintain rinsing head



Model	Weight	PU	No.
RODIADRILL 500	12.100 kg	1	FF40400

**Technical Data**

Input power	4,000 W
Output power	3,000 W
Speed	785 rpm



No. FF40150



No. 1000003978



No. FF35028



No. FF35700



No. FF35200



No. FF40056



SPEED STAR DX



DX High Speed Plus

Accessories	Page	No.
RODIADRILL Ceramic	55	FF40150
Pressurized water container 10l	67	FF35028
Vacuum pump RODIA-VAC	66	FF35200

Accessories	Page	No.
RODIA DW CLEANER M	69	1000003978
Water collecting ring, stationary	68	FF35700
Drill bits	61–65	

## RODIACUT 400 / RODIADRILL 500

RODIACUT 400 drill stand with combination drill mounting plate and RODIADRILL 500 drill motor for drilling  $\varnothing$  32–400 (500)<sup>1</sup> mm in reinforced concrete

### 2 applications in one unit:

$\varnothing$  32–400 mm for stationary wet drilling in (reinforced) concrete,  
 $\varnothing$  32–400 mm for stationary dry drilling in masonry

### Application Benefits

- Drill angle adjustments from -15° up to +45°, in 2.5° steps adjustable
- Exchangeable guide rail

2 applications with one device!

### Distance plate optional (No. FF35136)

To enlarge the drill hole diameter from  $\varnothing$  400 to 500 mm with RODIACUT 400 PRO



### Technical Data

Input power	4,000 W
Output power	3,000 W
Drilling stroke	430 mm
Drilling area concrete	400 mm
Drilling area masonry	400 mm

### 4 × roll guides

Precise and low vibration operation, flexible use / module concept

### Drill angle adjustments

Adjustable from -15° up to +45° in 2.5° steps

### Rubber transport wheels

Quick and easy transport on the building site

**Set (No. FF34500) includes:** drill stand RODIACUT 400 PRO (No. FF30030), drill motor RODIADRILL 500 (No. FF40400), tool bag (No. FF70001), spanner SW19 DIN895 (No. FF70019N), spanner SW24 DIN894 (No. FF70024), spanner SW32 DIN894 (No. FF70032), spanner SW41 DIN894 (No. FF70041), concrete fixing-set (No. FF35120), water supply hose + adaptor for Gardena coupling (No. FF35302), hammer drill SDS Plus 15 × 160 mm (No. 111429), copper ring 1.1/4" (No. FF35190), instruction manual drill stand RODIACUT 400 PRO (No. 1300002467), instruction manual RODIADRILL 500 (No. 1300002468), earplugs SaveRave (No. 4100000439), rubberized gloves (No. 4100000443), safety goggles HC/AF (No. 4100000441)

Model	Weight	PU	No.
Drill system RODIACUT 400 RODIADRILL 500	40.500 kg	1	FF34500
Drill system RODIACUT 400 RODIADRILL 500	28.400 kg	1	FF30030
Drill system RODIACUT 400 RODIADRILL 500	12.100 kg	1	FF40400



No. FF35029



No. FF35028



No. FF35190



No. FF35120



Extensions



SPEED STAR DX



DX High Speed Plus

### Accessories

	Page	No.
Pressurized water container 10l	67	FF35028
Fixing set	66	FF35120
Drill bits	61–65	

### Accessories

	Page	No.
Distance plate 60 mm		FF35136
Copper rings 1.1/4"	67	FF35190
Extensions for drill bits	68	

## High Speed Plus Natural Stone

Soldered diamond core wet cutting drill bit between Ø 6–67 mm for extremely hard materials

**Special wet drill bits** for drilling in natural stone, granite, marble, (double) baked brick, masonry, (reinforced) concrete, glass or hollow brickwork from Ø 6–67 mm.

**Typical areas of application** are HVAC&R, plumbing and electronic installations, old building renovations, laying tile, stairs and railing installation, air-conditioning technology, garden and landscaping

### Application Benefits

- Extremely easy cuts, very long service life through 9 mm high segments
- Suitable for all ROTHENBERGER drilling machines
- Balanced rotation reduces wear
- Drilling even through material combinations possible
- Drill holes on the seam or edge of material possible with the use of diamond rings
- Conventional G 1/2" threaded attachments

Suitable for all other drilling systems with G 1/2" and 1.1/4" UNC!



### Technical Data

Drill bits	Segments
Ø 6–40 mm	Ring segments
Ø 45–67 mm <sup>1</sup>	4–6

1) Single segment mounting from Ø 45 mm

9 mm high segments with high diamond concentration

Extremely easy cutting, very long service life in granite tiles



#### Overwound drill bits

Balanced rotation reduces wear

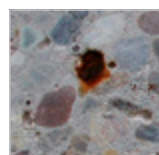
#### Threaded adaptor G 1/2"

Suitable for all other ROTHENBERGER drilling machines

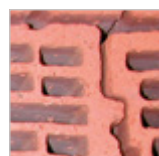
Drilling of the hardest materials



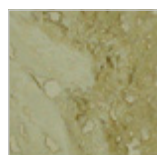
Reinf. concrete



Hollow brickwork



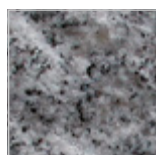
Marble



Masonry



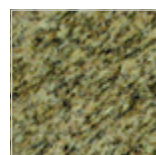
Granite



Aerated concrete



Green granite



Asphalt



#### Suitable for



RD 160



RD Ceramic



RD 200

Model	Weight	PU	Adaptor G 1/2" No.
High Speed Plus natural stone G1/2", D = 6,3 mm, NL = 55 mm	0.170 kg	1	FF44806
High Speed Plus natural stone G1/2", D = 8,3 mm, NL = 55 mm	0.170 kg	1	FF44808
High Speed Plus natural stone G1/2", D = 10 mm, NL = 55 mm	0.170 kg	1	FF44810
High Speed Plus natural stone G1/2", D = 12 mm, NL = 125 mm	0.190 kg	1	FF44812
High Speed Plus natural stone G1/2", D = 14 mm, NL = 125 mm	0.200 kg	1	FF44814
High Speed Plus natural stone G1/2", D = 15 mm, NL = 125 mm	0.200 kg	1	FF44815
High Speed Plus natural stone G1/2", D = 16 mm, NL = 125 mm	0.190 kg	1	FF44816
High Speed Plus natural stone G1/2", D = 20 mm, NL = 125 mm	0.220 kg	1	FF44820

## Core drilling

### Core drill bits

#### High Speed Plus Natural Stone

Model	Weight	PU	Adaptor G 1/2" No.
High Speed Plus natural stone G1/2", D=22 mm, NL=125 mm	0.220 kg	1	FF44822
High Speed Plus natural stone G1/2", D=24 mm, NL=125 mm	0.220 kg	1	FF44824
High Speed Plus natural stone G1/2", D=30 mm, NL=125 mm	0.250 kg	1	FF44830
High Speed Plus natural stone G1/2", D=35 mm, NL=125 mm	0.290 kg	1	FF44835
High Speed Plus natural stone G1/2", D=40 mm, NL=125 mm	0.340 kg	1	FF44840
High Speed Plus natural stone G1/2", D=50 mm, NL=125 mm	0.600 kg	1	FF44850
High Speed Plus natural stone G1/2", D=55 mm, NL=125 mm	0.570 kg	1	FF44855
High Speed Plus natural stone G1/2", D=60 mm, NL=125 mm	0.720 kg	1	FF44860
High Speed Plus natural stone G1/2", D=67 mm, NL=125 mm	0.790 kg	1	FF44867

#### DX-HIGH SPEED Plus universal drill bits

##### Space welding universal wet and dry drill bits Ø 20–300 mm

**Wet and dry drill bits** for drilling in reinforced concrete, asphalt, masonry as well as lime sand brick for Ø 20–300 mm  
**Typical areas of application** are HVAC&R and electronic installations, old building renovations, building industry, air-conditioning technology, garden and landscaping

##### Application Benefits

- Extremely easy cutting, safe cut in hand-operated use
- Faster cutting progress and extremely long service life
- Suitable for all other ROTHENBERGER drilling machines
- Balanced rotation reduces wear

Highest service life and universal application!



##### Technical Data

Drill bits	Segments G 1/2"	Segments G 1.1/4" UNC
Ø 20–40 mm	1	○
Ø 30–62 mm	○	1–6
Ø 42–62 mm	4–6	○
Ø 72–92 mm	7–8	7–8
Ø 102–152 mm	8–11	9–12
Ø 162–182 mm	○	12–14
Ø 200–300 mm	○	14–20

Extremely easy cuts, safe cuts in hand operated use

Special segment mix

Quicker drilling progress and extremely long service life



##### Space welding

Allows wet and dry use

##### Overwound drill bits

Balanced rotation reduces wear

##### Threaded adaptor G 1/2" and 1.1/4" UNC

Suitable for all other ROTHENBERGER drilling machines

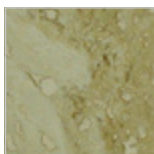


<sup>1</sup> When used as a dry drill, we recommend: RODIA DW CLEANER M (No. 1000003978)

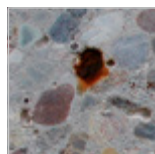
Hollow brickwork



Marble



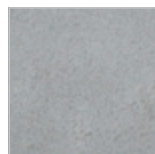
Reinf. concrete



Masonry



Pavement



Lime sand brick



## DX-HIGH SPEED Plus universal drill bits



Suitable for all other drilling systems  
with G 1/2" and 1.1/4" UNC!

Model	Weight	PU	Adaptor G 1/2" No.
DX High Speed Plus G1/2", D = 20 mm, NL = 300 mm	0.500 kg	1	FF44620
DX High Speed Plus G1/2", D = 30 mm, NL = 300 mm	0.600 kg	1	FF44630
DX High Speed Plus G1/2", D = 40 mm, NL = 300 mm	0.700 kg	1	FF44640
DX High Speed Plus G1/2", D = 52 mm, NL = 300 mm	0.895 kg	1	FF44650
DX High Speed Plus G1/2", D = 62 mm, NL = 300 mm	1.160 kg	1	FF44660
DX High Speed Plus G1/2", D = 72 mm, NL = 300 mm	1.420 kg	1	FF44670
DX High Speed Plus G1/2", D = 82 mm, NL = 300 mm	1.600 kg	1	FF44680
DX High Speed Plus G1/2", D = 92 mm, NL = 300 mm	1.900 kg	1	FF44690
DX High Speed Plus G1/2", D = 102 mm, NL = 300 mm	2.180 kg	1	FF44700
DX High Speed Plus G1/2", D = 112 mm, NL = 300 mm	2.400 kg	1	FF44710
DX High Speed Plus G1/2", D = 122 mm, NL = 300 mm	2.600 kg	1	FF44720
DX High Speed Plus G1/2", D = 132 mm, NL = 300 mm	2.900 kg	1	FF44730

Model	Weight	PU	Adaptor G 1.1/4" UNC No.
DX High Speed Plus 1.1/4" UNC , D = 32 mm, NL = 430 mm	0.700 kg	1	FF44030
DX High Speed Plus 1.1/4" UNC , D = 40 mm, NL = 430 mm	1.200 kg	1	FF44040
DX High Speed Plus 1.1/4" UNC , D = 52 mm, NL = 430 mm	1.600 kg	1	FF44050
DX High Speed Plus 1.1/4" UNC , D = 62 mm, NL = 430 mm	1.900 kg	1	FF44060
DX High Speed Plus 1.1/4" UNC , D = 72 mm, NL = 430 mm	2.300 kg	1	FF44070
DX High Speed Plus 1.1/4" UNC , D = 82 mm, NL = 430 mm	2.600 kg	1	FF44080
DX High Speed Plus 1.1/4" UNC , D = 92 mm, NL = 430 mm	3.000 kg	1	FF44090
DX High Speed Plus 1.1/4" UNC , D = 102 mm, NL = 430 mm	3.400 kg	1	FF44100
DX High Speed Plus 1.1/4" UNC , D = 112 mm, NL = 430 mm	3.800 kg	1	FF44110
DX High Speed Plus 1.1/4" UNC , D = 122 mm, NL = 430 mm	4.180 kg	1	FF44120
DX High Speed Plus 1.1/4" UNC , D = 125 mm, NL = 430 mm	4.300 kg	1	FF44125
DX High Speed Plus 1.1/4" UNC , D = 132 mm, NL = 430 mm	4.600 kg	1	FF44130
DX High Speed Plus 1.1/4" UNC , D = 142 mm, NL = 430 mm	5.000 kg	1	FF44140
DX High Speed Plus 1.1/4" UNC , D = 152 mm, NL = 430 mm	6.400 kg	1	FF44150
DX High Speed Plus 1.1/4" UNC , D = 162 mm, NL = 430 mm	7.000 kg	1	FF44160
DX High Speed Plus 1.1/4" UNC , D = 172 mm, NL = 430 mm	7.500 kg	1	FF44170
DX High Speed Plus 1.1/4" UNC , D = 182 mm, NL = 430 mm	8.000 kg	1	FF44180
DX High Speed Plus 1.1/4" UNC , D = 200 mm, NL = 430 mm	9.000 kg	1	FF44200
DX High Speed Plus 1.1/4" UNC , D = 220 mm, NL = 430 mm	11.400 kg	1	FF44220
DX High Speed Plus 1.1/4" UNC , D = 250 mm, NL = 430 mm	13.600 kg	1	FF44250
DX High Speed Plus 1.1/4" UNC , D = 300 mm, NL = 430 mm	19.300 kg	1	FF44300

**SPEED STAR DX**

Space welding wet and dry drill bits between Ø 10–500 mm

**Wet and dry drill bits** for asphalt, masonry as well as natural and artificial stone between Ø 10–500 mm

**Typical areas of application** are HVAC&R, plumbing, old building renovations, building industry, air-conditioning technology, gardening and landscaping

**Application Benefits**

- Extremely easy cuts, safe cut in hand-operated use
- Balanced rotation reduces wear
- Suitable for all other ROTHENBERGER drilling machines
- Standard lengths 400 / 500 mm, special lengths available on request
- Conventional G 1/2" and 1.1/4" UNC threaded adaptors



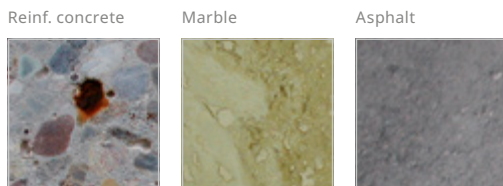
**Technical Data**

Drill bits	Segments
Ø 10–38 mm	1
Ø 40–55 mm	1–6
Ø 56–102 mm	6–8
Ø 107–142 mm	9–11
Ø 142–182 mm	11–14
Ø 182–250 mm	14–16
Ø 300–500 mm	16–26

Special drill bits for asphalt, pavement as well as special lengths up to 1,000 mm available upon request !



<sup>1</sup> When used as a dry drill, we recommend: RODIA DW CLEANER M (No. 1000003978)



**PRISMACUT**  
For better drill behaviour



Model	Weight	PU	Adaptor G 1/2" No.
SPEED STAR DX, G1/2", D = 10 mm, NL = 400 mm	0.320 kg	1	FF00610
SPEED STAR DX, G1/2", D = 12 mm, NL = 400 mm	0.315 kg	1	FF00612
SPEED STAR DX, G1/2", D = 16 mm, NL = 400 mm	0.360 kg	1	FF00616
SPEED STAR DX, G1/2", D = 18 mm, NL = 400 mm	0.365 kg	1	FF00618
SPEED STAR DX, G1/2", D = 20 mm, NL = 400 mm	0.435 kg	1	FF00620
SPEED STAR DX, G1/2", D = 25 mm, NL = 400 mm	0.470 kg	1	FF00625
SPEED STAR DX, G1/2", D = 32 mm, NL = 400 mm	0.590 kg	1	FF00632
SPEED STAR DX, G1/2", D = 40 mm, NL = 400 mm	0.780 kg	1	FF00640
SPEED STAR DX, G1/2", D = 46 mm, NL = 400 mm	0.835 kg	1	FF00645
SPEED STAR DX, G1/2", D = 52 mm, NL = 400 mm	0.980 kg	1	FF00650
SPEED STAR DX, G1/2", D = 56 mm, NL = 400 mm	1.330 kg	1	FF00655



## SPEED STAR DX



Suitable for all other drilling systems with G 1/2" and 1.1/4" UNC!



2

Model	Weight	PU	Adaptor G 1/2" No.
SPEED STAR DX, G1/2", D=66 mm, NL=400 mm	1.300 kg	1	FF00665
SPEED STAR DX, G1/2", D=76 mm, NL=400 mm	1.900 kg	1	FF00675
SPEED STAR DX, G1/2", D=82 mm, NL=400 mm	2.070 kg	1	FF00680
SPEED STAR DX, G1/2", D=102 mm, NL=400 mm	2.510 kg	1	FF00700
SPEED STAR DX, G1/2", D=112 mm, NL=400 mm	2.940 kg	1	FF00710
SPEED STAR DX, G1/2", D=132 mm, NL=400 mm	3.470 kg	1	FF00730

Model	Weight	PU	Adaptor G 1.1/4" No.
SPEED STAR DX 1.1/4" UNC, D=25 mm, NL=430 mm	0.860 kg	1	FF00025
SPEED STAR DX 1.1/4" UNC, D=30 mm, NL=430 mm	0.950 kg	1	FF00030
SPEED STAR DX 1.1/4" UNC, D=46 mm, NL=430 mm	1.180 kg	1	FF00045
SPEED STAR DX 1.1/4" UNC, D=52 mm, NL=430 mm	1.650 kg	1	FF00050
SPEED STAR DX 1.1/4" UNC, D=56 mm, NL=430 mm	1.750 kg	1	FF00055
SPEED STAR DX 1.1/4" UNC, D=66 mm, NL=430 mm	2.020 kg	1	FF00065
SPEED STAR DX 1.1/4" UNC, D=76 mm, NL=430 mm	2.420 kg	1	FF00075
SPEED STAR DX 1.1/4" UNC, D=102 mm, NL=430 mm	3.270 kg	1	FF00100
SPEED STAR DX 1.1/4" UNC, D=112 mm, NL=430 mm	3.710 kg	1	FF00110
SPEED STAR DX 1.1/4" UNC, D=122 mm, NL=430 mm	4.020 kg	1	FF00120
SPEED STAR DX 1.1/4" UNC, D=132 mm, NL=430 mm	5.150 kg	1	FF00130
SPEED STAR DX 1.1/4" UNC, D=142 mm, NL=430 mm	5.470 kg	1	FF00140
SPEED STAR DX 1.1/4" UNC, D=152 mm, NL=430 mm	6.020 kg	1	FF00150
SPEED STAR DX 1.1/4" UNC, D=162 mm, NL=430 mm	6.620 kg	1	FF00160
SPEED STAR DX 1.1/4" UNC, D=200 mm, NL=430 mm	8.550 kg	1	FF00200
SPEED STAR DX 1.1/4" UNC, D=250 mm, NL=430 mm	12.130 kg	1	FF00250
SPEED STAR DX 1.1/4" UNC, D=280 mm, NL=430 mm	17.600 kg	1	FF00280
SPEED STAR DX 1.1/4" UNC, D=300 mm, NL=430 mm	19.300 kg	1	FF00300
SPEED STAR DX 1.1/4" UNC, D=350 mm, NL=430 mm	21.000 kg	1	FF00350
SPEED STAR DX 1.1/4" UNC, D=500 mm, NL=430 mm	39.100 kg	1	FF00500

## Core drilling

### Core drilling accessories / Core drill bits

#### Vacuum pump RODIA-VAC

This vacuum pump is suitable for all diamond core drilling units. An extraction tank prevents the vacuum plate from loosening quickly during a sudden power failure. Oil-free vacuum pump with pressure gauge.



1.1 kW motor power 85% Vacuum  
200 l/min extraction volume

10 l extraction tank

Safety during power failure

Drill stand can only be mounted with a combination of vacuum plate and vacuum set!



Model	Weight	PU	No.
RODIA-VAC incl. 10 l Tank, 230V	20.000 kg	1	FF35200

#### Quick clamping column

Toolless and reliable bracing between floor and wall or wall and wall. Maximum operation range from 1.7 m up to 3.0 m with a load capacity up to 500 kg with sideway guidance.



Model	Weight	PU	No.
Quick Clamping Column, operation 1.7 to 3.0 m	9.000 kg	1	FF35015

#### Special diamond drills for tiles and natural stone



For use when hammer drills can not do the job. Various material combinations, such as tiles on concrete, can be easily drilled without damage.

Special diamond drills

For tiles and natural stone



Model	Weight	PU	No.
High Speed Plus natural stone G1/2", D = 15 mm, EL = 125 mm	0.200 kg	1	FF44815
High Speed Plus natural stone G1/2", D = 20 mm, EL = 125 mm	0.220 kg	1	FF44820

#### Vacuum sets



Model	Weight	PU	No.
Vacuum Set for RODIACUT 202DWS/270C	1.115 kg	1	FF35740
Vacuum set for RODIACUT 131/170-C	1.100 kg	1	FF35710

#### Fixing set concrete / masonry



Set (No. FF35120) includes: knurled thread rod type G-B 160 mm, screw thread M 12 / 20 mm (No. FF35129), U-washer (No. FF70166), winged nut M 12 (No. FF55150), 25 x drive-in anchor M 12 (No. FF35122) and drive-in iron (No. FF35128)

Set (No. FF35121) includes: knurled thread rod type G-M 280 mm, screw thread M 12 / 85 mm (No. FF35130), U-washer (No. FF70166), winged nut M 12 (No. FF55150), hexagonal nut M12 (No. FF70167), 5 x Rawl anchor M 12 (reusable) (No. FF35126) and drive-in iron (No. FF35128)

Model	Weight	PU	No.
Fixing set concrete	1.000 kg	1	FF35120
Fixing set masonry	1.100 kg	1	FF35121

#### Thread interfaces

Between motor connection and drill bit



Model	Weight	PU	No.
Thread adaptor 1.1/4" UNC(I) to G1/2"(I)	0.700 kg	1	FF35095
Thread adaptor G1/2" to 1.1/4" UNC	0.500 kg	1	FF35080

**Copper rings**

Levels out the unevenness between motor connection and drill bit. Easy loosening prevents drill bits from getting stuck on the driveshaft.



Model	Weight	PU	No.
Copper rings 1.1/4"	0.050 kg	1	FF35190

**SDS-plus hammer drill**

For drilling in granite, concrete, concrete reinforcement, clinker, stone, masonry and marble



Model	Weight	PU	No.
SDS-plus hammer drill 15 x 160 mm	0.160 kg	1	111429
SDS-plus hammer drill 20 x 450 mm	0.060 kg	1	111450

**Water supply**

The sturdy 10 liter pressurized water container made of steel is perfectly suited for individual drilling. When drilling large diameters or series drillings, the fully submersible RODIAPUMP enables a mobile supply of water from buckets or other containers up to a delivery height of 5 meters using a 1" water hose.

**Application Benefits**

- Robust steel tank designed for a long service life
- Pressure gauge with display, ideal for setting the water pressure
- 2.5 meters connection hose with quick-connect coupling, drip-free connection to drilling motors
- 10 liters of water, can support 3-4 drilling
- Metal hose connection



Model	Weight	PU	No.
Pressurized water container capacity 10 l	5.500 kg	1	FF35028
Water supply for RODIADRILL	0.200 kg	1	FF35301
Water supply hose with Aqua-Stop	0.111 kg	1	FF35302

**Water extraction systems**

The dirty cooling water is extracted in connection with a wet and dry vacuum (No. 1000003978)

**Application Benefits**

- Fast, tool-free attachment to the RODIACUT 150 / 250 drill stand, thanks to integrated metal clamps
- Replaceable rubber membranes serve as splash protection, ideal for different drill bit dimensions
- Sealing rubber at the bottom of the water suction ring ensures tightness and thus leakage protection



No. FF35700



No. FF35730

Model	Weight	PU	No.
Water collection ring for RODIACUT 131 DWS, 150 and 170 C stationary, up to Ø 132 mm	1.200 kg	1	FF35700
Water collection ring for RODIACUT 202 DWS, 250 and 270 C stationary, up to Ø 200 mm	2.500 kg	1	FF35730

**Extensions for drill bits 1.1/4" UNC**

The robust steel extensions can be used to quickly increase the drilling depth. Extensions with the same coupling can be linked together

**Application Benefits**

- Easy extension of the drilling depth
- High-quality and robust steel design



Model	Weight	PU	No.
1.1/4" UNC, EL = 100 mm	1.000 kg	1	FF35060
1.1/4" UNC, EL = 200 mm	2.000 kg	1	FF35065
1.1/4" UNC, EL = 300 mm	2.950 kg	1	FF35070
1.1/4" UNC, EL = 500 mm	5.120 kg	1	FF35075

**Extensions for drill bits G 1/2"**

With this high-quality and robust drill bit extension made of steel and a threaded connection G 1/2", the drilling depth can be extended safely and reliably. All commercially available drill bits with this connection can use this extension.

**Application Benefits**

- Easy extension of the drilling depth
- High-quality and robust steel design



Model	Weight	PU	No.
G 1/2", EL = 100 mm	0.400 kg	1	FF35040
G 1/2", EL = 200 mm	0.900 kg	1	FF35045
G 1/2", EL = 300 mm	1.400 kg	1	FF35050
G 1/2", EL = 500 mm	2.400 kg	1	FF35055

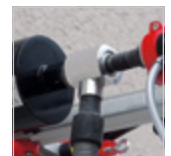
**RODIADUST**

Universal adaptor for wet drilling machines for dust-free dry drilling

Provides optimum extraction results in conjunction with RODIA DW CLEANER M (No. 1000003978 ) and increases the drilling process, prevents jamming of drill bit and reduces segment wear.

**Application Benefits**

- Adaptor for drill bits 1.1/4" UNC for dust-free dry drilling in connection with dry vacuum cleaner and drill
- Reduces bit jamming and increases drilling progress
- Different vacuum cleaner connections possible via adapter piece



Model	Weight	PU	No.
RODIADUST 1.1/4" UNC	1.900 kg	1	FF40056

## RODIA DW CLEANER M

Especially good in combination with RODIADRILL 1800 DRY or the suction system RODIADUST from ROTHENBERGER. Optimum suction results and increases work progress, prevents tool jamming and reduces wear

**Constant extraction power!  
Automatic filter-cleaning function!**

### Application Benefits

- Compact wet and dry extraction unit with 4 casters for easy operation
- Dust protection class M for high cleaning efficiency
- High cleaning efficiency due to 2 polyester filter cassettes with up to 99.9% dust retention capacity
- High ease of use due to enormous working radius of 13 meters, 8 meters power cord and 5 meters suction hose
- Special suction hose, very robust and resistant in the daily works
- Automatic shaking of the filter cassettes ensures constant suction power
- Volume flow regulator and automatic socket for optimal ease of use

### Technical Data

Voltage	240 V
Sound power level (LwA)	69 dB(A)
Power	1,600 W
Hose length	5 m

### Separate automatic outlet

Adaptor for further electric tools

### High cleaning efficiency

2 polyester-filter cassettes with 99.9% dust retention

### Dust protection class M

Allows working with hazardous dusts with a limit value  $> 1 \text{ mg/m}^3$

### User comfort with a wide operating range

5 m long suction hose and 8 m long AC power cord



Model	Weight	PU	No.
RODIA DW CLEANER M	12.200 kg	1	1000003978








## Bending







<b>System overview</b>	<b>72-73</b>
<b>Manual</b>	
Bender one-handed	74-76
Bending pliers	77-78
Tube bending springs CU	79
Internal bending springs MLP	79
Vice bender	80-81
<b>Manuell hydraulic</b>	
Bender, manual hydraulic	82-83
<b>Electro hydraulic</b>	
Bender, electro hydraulic	84-85
<b>Electro</b>	
Bender, electric	86-89
<b>Bending tables</b>	<b>90-93</b>

3

**Push bending**

	<b>TUBE BENDER</b>	<b>TUBE BENDER MAXI</b>	<b>TUBE BENDER MAXI MLP</b>
			
<b>Method</b>	Manual 90°	Manual 90°	Manual 90°
<b>Working range:</b> Copper	Ø 5–12 mm (1/4–1/2") +Ø 1 mm, soft	Ø 12–22 mm (3/8–7/8") +Ø 1 mm, soft	○
<b>Working range:</b> Aluminium	Ø 5–12 mm (1/4–1/2") +Ø 1 mm, soft	Ø 12–22 mm (3/8–7/8") +Ø 1 mm, soft	○
<b>Working range:</b> Precision steel	Ø 5–12 mm (1/4–1/2") +Ø 1 mm, soft	Ø 12–22 mm (3/8–7/8") +Ø 1 mm, soft	○
<b>Working range:</b> Stainless steel	○	○	○
<b>Working range:</b> MLP	○	Ø 14–26 mm (5/8–7/8") +Ø 3 mm	Ø 14–32 mm (1/4–1/2") +Ø 3 mm
<b>Page</b>	<b>74</b>	<b>75</b>	<b>76</b>

**Pull bending**

	<b>Standard bending plier</b>	<b>MULTIBEND</b>	<b>MINIBEND</b>	<b>Standard bender 180°</b>
				
<b>Method</b>	Manual 90°	Manual 180°	Manual 180°	Manual 180°
<b>Working range:</b> Copper	Ø 12–22 mm +Ø 1 mm, semi-hard	Ø 10–18 mm (1/4–5/8") +Ø 1 mm, soft	Ø 6–10 mm (1/4–3/8") +Ø 1 mm, soft	Ø 6–18 mm (1/4–5/8") +Ø 1 mm, soft
<b>Working range:</b> Aluminium	○	Ø 10–18 mm (1/4–5/8") +Ø 1 mm, soft	Ø 6–10 mm (1/4–3/8") +Ø 1 mm, soft	Ø 6–18 mm (1/4–5/8") +Ø 1 mm, soft
<b>Working range:</b> Precision steel	○	Ø 10–18 mm (1/4–5/8") +Ø 1 mm, soft	Ø 6–10 mm (1/4–3/8") +Ø 1 mm, soft	Ø 6–18 mm (1/4–5/8") +Ø 1 mm, soft
<b>Working range:</b> Stainless steel	○	○	○	○
<b>Working range:</b> MLP	○	○	○	○
<b>Page</b>	<b>77</b>	<b>77</b>	<b>78</b>	<b>78</b>



**Push bending**

**ROBULL Typ E**

**ROBULL Typ ME**



Method	Manual hydraulic 90°	Elektro hydraulic 90°
Working range: Copper	○	○
Working range: Aluminium	○	○
Working range: Precision steel	Ø 3/8-2"	Ø 3/8-2"
Working range: Stainless steel	○	○
Working range: MLP	○	○
<b>Page</b>	<b>82</b>	<b>84</b>

3

**Pull bending**

**PRO BENDER**

**ROBEND H+W Plus**

**ROBEND 4000 E**

**ROBEND 4000**



Method	Manual 180°	Manual 180°	Elektric 180°	Elektric 180°
Working range: Copper	Ø 10-16 mm (3/8-3/4") +Ø 1 mm, soft, semi-hard, hard	Ø 8-22 mm (5/16-7/8") +Ø 1 mm, soft, semi-hard, hard	Ø 12-35 mm (1/2-1.3/8") +Ø 1.6 mm, soft, semi-hard, hard	Ø 12-35 mm (1/2-1.3/8") +Ø 1.6 mm, soft, semi-hard, hard
Working range: Aluminium	○	Ø 8-22 mm (5/16-7/8") +Ø 1 mm, soft	Ø 12-28 mm (1/2-1.1/8") +Ø 2 mm, soft, semi-hard, hard	Ø 12-28 mm (1/2-1.1/8") +Ø 2 mm, soft, semi-hard, hard
Working range: Precision steel	○	Ø 10-22 mm (3/8-5/8") +Ø 1 mm, soft	Ø 12-28 mm (1/2-1.1/8") +Ø 2 mm, soft	Ø 12-28 mm (1/2-1.1/8") +Ø 2 mm, soft
Working range: Stainless steel	Ø 10-16 mm (3/8-3/4") +Ø 1 mm, soft, semi-hard, hard	Ø 8-22 mm (5/16-7/8") +Ø 1 mm	Ø 12-28 mm (1/2-1.1/8") +Ø 1.5 mm, soft	Ø 12-28 mm (1/2-1.1/8") +Ø 1.5 mm, soft
Working range: MLP	○	○	○	○
<b>Page</b>	<b>77</b>	<b>80</b>	<b>86</b>	<b>88</b>

**TUBE BENDER**

**Manual bending device for bending tubes in dimensions 5-12 mm (1/4-1/2")**



Suitable for pipes made of:

**Copper (soft) and aluminium:** Ø5-12 mm, 1/4-1/2"

**Precision steel (soft):** Ø5-12 mm, 1/4-1/2"

**Application Benefits**

- Dimensionally accurate bending even in constrained positions
- Production of overbends, counterbends, floor bends and connecting bends possible in all planes
- Simple and fast change of the bending segment
- Quick release and reset of the bending segment
- One-handed operation due to ergonomic design
- Fast and precise bending



Model	Weight	PU	No.
TUBE BENDER set 5-6-8-10 mm	2.840 kg	1	24131
TUBE BENDER set 6-8-10-12 mm	3.030 kg	1	24132
TUBE BENDER set 8-10-12 mm	2.820 kg	1	24133
TUBE BENDER set 1/4-5/16-3/8-1/2"	2.920 kg	1	24134
TUBE BENDER bare tool without bending segments	0.360 kg	1	766004016
Side shape for TUBE BENDER MAXI 1 piece	0.050 kg	1	24048
Counter-holding plate without side shapes	0.140 kg	1	24049

**TUBE BENDER bending segment**



Model	Weight	PU	No.
Bending segment for TUBE BENDER 5 mm (3/16")	0.190 kg	1	24001
Bending segment for TUBE BENDER 6 mm (1/4")	0.210 kg	1	R2403200
Bending segment for TUBE BENDER 8 mm (5/16")	0.250 kg	1	R2403300
Bending segment for TUBE BENDER 9 mm	0.360 kg	1	R2403400
Bending segment for TUBE BENDER 10 mm	0.390 kg	1	R2403500
Bending segment for TUBE BENDER 12 mm	0.390 kg	1	24007
Bending segment for TUBE BENDER 3/8"	0.270 kg	1	24006
Bending segment for TUBE BENDER 1/2"	0.390 kg	1	24008

## TUBE BENDER MAXI

For accurate one-handed bending up to 90°, Ø 12–26 mm (3/8–7/8")

For the bending of pipes made of soft copper and aluminium, coated copper and precision steel pipes as well as multilayered composite pipes. Suitable for pipe made of:

**Copper (soft) and aluminium:** Ø 10–22 mm, 3/8–7/8"  
**Copper (coated):** Ø 10–18 mm, 3/8–5/8"  
**Precision steel (soft):** Ø 10–22 mm, 3/8–7/8"  
**MLP (Multilayer):** Ø 14–26 mm, 5/8–7/8"

### Application Benefits

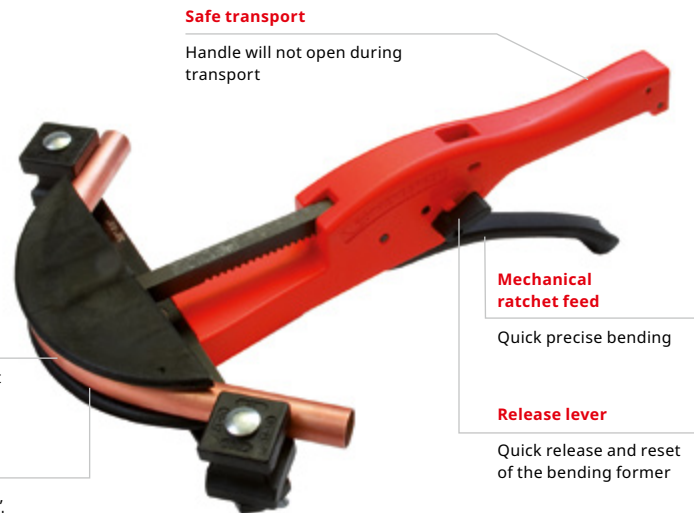
- Eliminates the cost for bending formers, storage and purchase
- Quick release and reset of the bending segments
- Bending segments are easily exchanged
- Optimum bending results

#### Optimum bending results

Plastic bending segments and support segments with increased conductivity

#### Adjustable bending frame

Production of U-bends, counter bends, swan-neck bends and connecting bends possible at all levels



Model	Weight	PU	No.
TUBE BENDER MAXI set 12–15–18–22 mm	3.500 kg	1	023020X
TUBE BENDER MAXI set 12–14–16–18–22 mm	3.500 kg	1	023021X
TUBE BENDER MAXI set 3/8–1/2–5/8–3/4–7/8"	3.300 kg	1	023022X
TUBE BENDER MAXI set MLP 14–16–18–20–25 mm	3.300 kg	1	023090X
TUBE BENDER MAXI set MLP 14–16–18–20–26 mm	3.300 kg	1	023091X
TUBE BENDER MAXI bare tool without bracket	1.000 kg	1	766100016
Side shape set for TUBE BENDER MAXI MLP R/L, 14–25 mm	0.500 kg	1	23008
Side shape set for TUBE BENDER MAXI R/L, 12–22 mm (1/2–7/8")	0.100 kg	1	23047



## TUBE BENDER Maxi bending segment

Model	Weight	PU	No.	Model	Weight	PU	No.
Bending segment 10 mm	0.080 kg	1	23001	Bending segment 20 mm	0.150 kg	1	23052
Bending segment 12 mm	0.080 kg	1	23002	Bending segment 22 mm	0.170 kg	1	23007
Bending segment 14 mm	0.080 kg	1	23003	Bending segment 3/8"	0.070 kg	1	23010
Bending segment 15 mm	0.090 kg	1	23004	Bending segment 1/2"	0.080 kg	1	23011
Bending segment 16 mm	0.100 kg	1	23005	Bending segment 5/8"	0.100 kg	1	23012
Bending segment 18 mm	0.140 kg	1	23006	Bending segment 3/4"	0.120 kg	1	23013

**TUBE BENDER MAXI MLP**

**One-handed bending tool for precision bending of multi-layered composite pipes (MLP), Ø 14–32 mm**

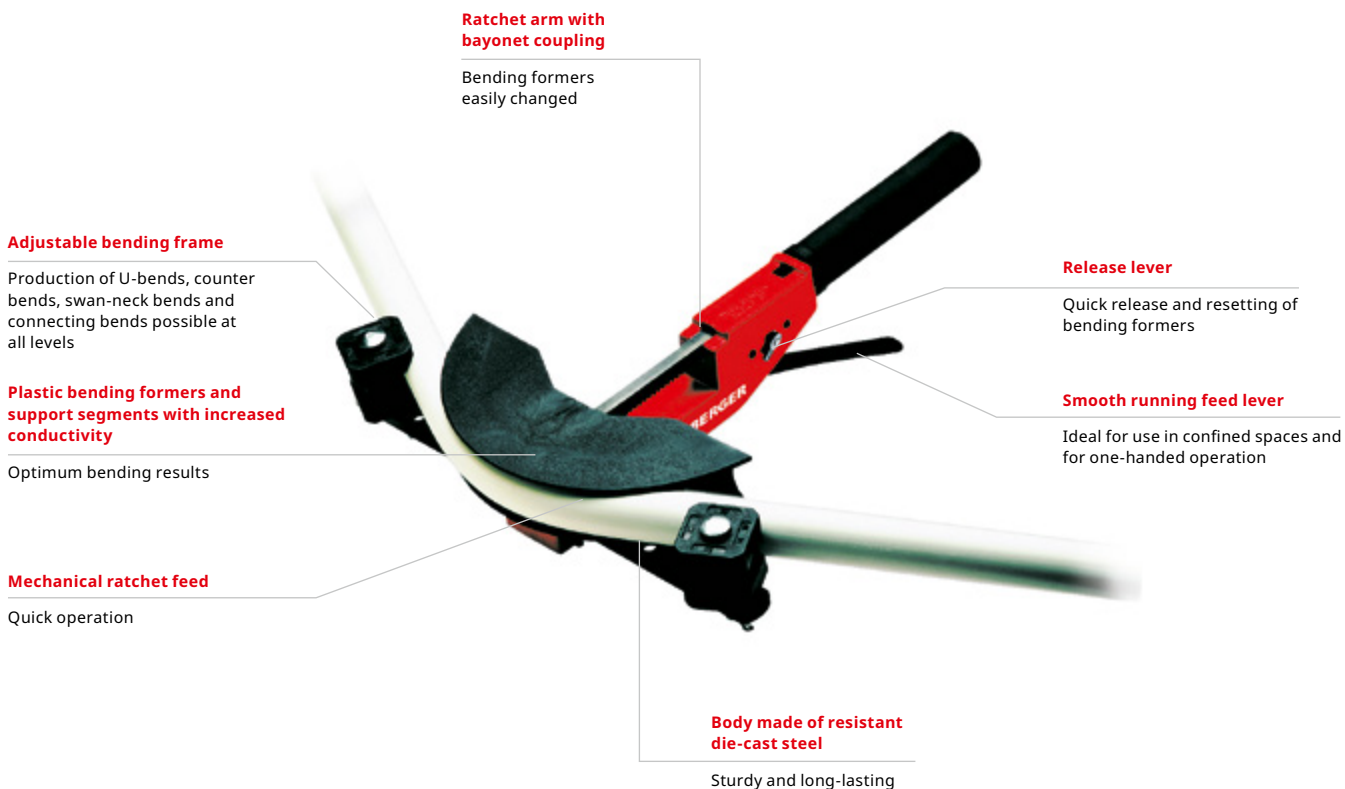
Universal bending tool. Increases safety by reducing the number of joints. Eliminates the costs for bending formers, storage and purchase.

**Application Benefits**

- Ideal in confined spaces
- Quick release and resetting of bending formers
- Bending formers easily changed
- Optimal bending results
- Reduction of pressure-loss in the unit due to the low cross-sectional constriction as compared to prefabricated form pieces



3



Model	Weight	PU	No.
TUBE BENDER MAXI MLP 14–16–18–20–25–32 mm	4.690 kg	1	23065
TUBE BENDER MAXI MLP 14–16–18–20–26–32 mm	8.300 kg	1	23095



Accessories	Weight	No.	Accessories	Weight	No.
Bending segment 14 × 2.0 mm	0.080 kg	23003	Bending segment 26 × 2.0 mm	0.200 kg	23053
Bending segment 16 × 2.0 mm	0.100 kg	23005	Bending segment 32 × 2.0 mm	0.380 kg	23051
Bending segment 18 × 2.0 mm	0.140 kg	23050	Basic tool 32 w/o support brackets	1.280 kg	23076
Bending segment 20 × 2.0 mm	0.150 kg	23052	Support brackets (No. 23076)	0.790 kg	23080
Bending segment 25 × 2.0 mm	0.180 kg	23009	Support segment MLP (No. 23076)	0.200 kg	23083

### PRO BENDER

For bending of pipes out of copper, stainless steel and carbon steel in the sizes Ø 10 and 16 mm (3/8-3/4")

Suitable for bending copper, stainless steel and carbon steel pipes with Ø 10 and 16 mm (3/8-3/4")

#### Application Benefits

- Bending of pipes out of copper, stainless steel and carbon steel possible
- Long lasting due to forged cast iron body
- Comfortable working due to long levers and rubber handles
- Clamping surface for working with a vice



Model	Weight	PU	No.
PRO BENDER 10 mm (3/8")	2.200 kg	1	1000001431
PRO BENDER 1/2"	2.100 kg	1	767050016
PRO BENDER 16 mm (5/8")	4.000 kg	1	1000000445
PRO BENDER 3/4"	3.900 kg	1	767750016

### MULTIBEND

For accurate bending up to 180° of pipes made of soft copper, aluminium and precision steel Ø 10-18 mm (1/4-5/8")

#### Application Benefits

- Bending radius display of 0-180° for accurate bending
- Clamp mechanism for better pipe hold allows the bending of shorter pipe pieces
- Light construction allows for fatigue-free hand operation



#### Measurement scale

Accurate bending possible

Model	Weight	PU	No.
MULTIBEND 180°, 10 mm	0.370 kg	1	25401
MULTIBEND 180°, 12 mm	0.640 kg	1	25402
MULTIBEND 180°, 14 mm	0.980 kg	1	25403
MULTIBEND 180°, 15 mm	1.450 kg	1	25404
MULTIBEND 180°, 16 mm (5/8")	1.460 kg	1	25405
MULTIBEND 180°, 18 mm	2.000 kg	1	25406

### Standard bending plier 90°

For accurate bending up to 90° for pipes made of semi-hard copper according to DIN EN 1057, Ø 12 x 1.0-22 x 1.0 mm

#### Application Benefits

- Universal bender for sanitary and heating installations refrigeration and air-conditioning systems
- Long handles allow for better leverage in the bending of semihard copper pipes
- Bending pliers with sliding carriage for millimetre-exact bending
- Accurate adjustments between the bending radius and handle length reduces effort required



Model	Weight	PU	No.
12 mm, R 44 mm	1.400 kg	1	462212
15 mm, R 60 mm	2.300 kg	1	462215
18 mm, R 74 mm	3.200 kg	1	462218
22 mm, R 60 mm	4.300 kg	1	462222

## Bending

### Manual bending devices

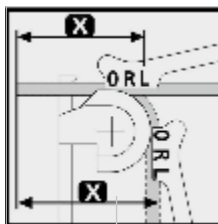
#### MINIBEND

For accurate two handed bending up to 180° of pipes made of soft copper, brass, aluminium and precision steel Ø 6–10 mm (1/4–3/8")

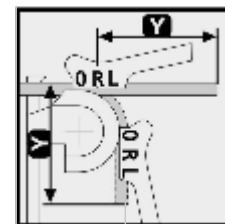
##### Application Benefits

- Suitable for use in refrigeration and air-conditioning, oil supply, automotive, hydraulic and pneumatic industries

Method L



Method R



##### Accurate bending

Minimum size chord and bending radius display on measurement scale

Model	Weight	PU	No.
MINIBEND 1/4–5/16–3/8"	0.420 kg	1	25151
MINIBEND 6–8–10 mm	0.420 kg	1	25150

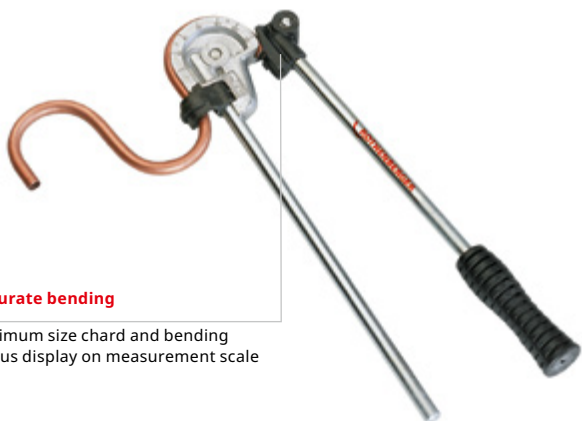
#### Standard bender 180°

For accurate bending up to 180° of pipes made of soft copper, aluminium and precision steel Ø 6–18 mm (1/4–5/8")

Manual bending device for bending pipes with Ø 6–18 mm (1/4–5/8")

##### Application Benefits

- Bending angle measurement of 0–180° for accurate bending
- Clamp mechanism for better pipe hold allows the bending of shorter pipe pieces
- Light construction allows for fatigue-free hand operation



##### Accurate bending

Minimum size chord and bending radius display on measurement scale

Model	Weight	PU	No.
6 mm	0.550 kg	1	25130
8 mm (5/16")	0.640 kg	1	25131
10 mm	0.970 kg	1	25132
12 mm	0.980 kg	1	25133
14 mm	1.580 kg	1	25134
15 mm	1.830 kg	1	25135
16 mm (5/8")	1.830 kg	1	25136
18 mm	2.110 kg	1	25137
1/4"	0.560 kg	1	25140
1/2"	1.680 kg	1	25142

##### Accessories



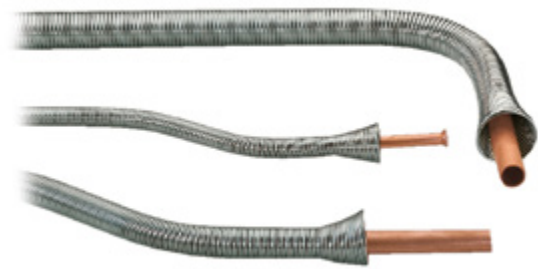
Description	Page	No.
Internal / external deburrer	37	1500000236
Bending spray, 150 ml	79	25120

### Copper external bending springs

For free-handed bending of soft copper pipes  
 Ø 8-16 mm (1/4-5/8")

#### Application Benefits

- Coiled cone for ideal handling even with longer pipes
- Tough and long lasting with the cadmium-plated spring steel
- Optimal spring form prevents buckling in bending radius area



Model	Weight	PU	No.
8 mm	0.070 kg	1	25181
10 mm	0.080 kg	1	25182
12 mm	0.160 kg	1	25183
15 mm	0.220 kg	1	25185
16 mm	0.230 kg	1	25186

Model	Weight	PU	No.
5/16"	0.070 kg	1	25181
1/2"	0.130 kg	1	25190
5/8"	0.220 kg	1	25186

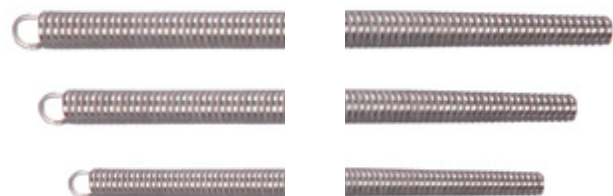
### MLP internal bending springs

For hand bending of aluminium multi-layer pipes (MLP)  
 Ø 6-20 mm

For hand bending soft copper pipe

#### Application Benefits

- Ideal operation even with longer pipes:  
 Grip ring for retraction out of the pipe
- Entry taper for clean insertion in the pipe
- Sturdy and long lasting; NIROSTA spring steel
- Pipe will not buckle due to optimal spring form



**Grip ring**  
 for insertion into and retraction out of the pipe

**Entry taper**  
 for clean insertion in the pipe

Outer Pipe Diameter	Weight	PU	No.
12 mm	0.090 kg	1	25441
14 mm	0.120 kg	1	25442
16 mm	0.150 kg	1	25443

Outer Pipe Diameter	Weight	PU	No.
20 mm	0.220 kg	1	25445
25/26 mm	0.380 kg	1	25446

### Bending spray

For bending copper and steel pipes

Bending spray for easier bending of pipes made of copper, carbon steel and stainless steel

#### Application Benefits

- Combination of slide and bending oil
- Because of the special viscosity even copper and steel pipes are able to be bent easily



Model	Weight	PU	No.
Bending spray 150 ml	0.150 kg	1	25120

## Bending

### Manual bending devices

#### ROBEND H+W PLUS bender

For accurate cold bending up to 180°,  
Ø 8–22 mm (5/16–7/8")



For accurate bending up to 180° on pipes made of:

**Copper (soft, semi-hard, hard thin-walled):**  
Ø 8–22 mm (5/16–7/8")

**Copper (coated, also thin-walled):**  
Ø 10–18 mm (3/8–5/8")

**Aluminium and brass:**  
Ø 8–22 mm (5/16–7/8")

**Precision steel (also coated):**  
Ø 10–22 mm (3/8–5/8")

**Seamless stainless steel:**  
Ø 8–22 mm (5/16–7/8")

#### Application Benefits

- Exact bending to the mm on continuous pipe
- Retains shape and remains stable
- Two-handed bending possible with the additional handle up to Ø 18 mm (5/8")
- Eliminates the costs of purchase and storage of bending formers
- Easy bending through clamping on a vice
- Exact bending with the minimum size chart and bending radius display

3

**Optimum combination of ROLUB guide shoe and the bending former**

Perfect bending results without friction marks

**Minimum size chart and bending radius display**

Accurate bending

**Bending formers with base plate**

Easy bending through clamping on a vice

#### ROLUB-Anti-Block-System

Less effort due to lower friction and optimum distribution of the bending spray

#### ROLUB-Anti-Block-System!

**Made from high-quality forged aluminium**

Retains shape and remains stable

**Thread for the attachment of the additional lever (accessories)**

Free-hand bending possible



Model	Weight	PU	No.
ROBEND H+W PLUS with handle bar, 8 mm 5/16", R 22 mm	0.660 kg	1	24508
ROBEND H+W PLUS with handle bar, 10 mm, R 32 mm	1.180 kg	1	24510
ROBEND H+W PLUS with handle bar, 12 mm, R 38 mm	1.110 kg	1	24512
ROBEND H+W PLUS with handle bar, 14 mm, R 45 mm	1.370 kg	1	24514
ROBEND H+W PLUS with handle bar, 15 mm, R 45 mm	1.375 kg	1	24515
ROBEND H+W PLUS with handle bar, 16 mm 5/8", R 64 mm	2.620 kg	1	24516
ROBEND H+W PLUS with handle bar, 18 mm, R 64 mm	2.620 kg	1	24518
ROBEND H+W PLUS with handle bar, 22 mm 7/8", R 81 mm	3.800 kg	1	24522
ROBEND H+W PLUS with handle bar, 3/4", R 81 mm	3.850 kg	1	24519
ROBEND H+W PLUS with handle bar, 1/2"	1.110 kg	1	24552



## ROBEND H+W PLUS bending sets

For accurate cold bending up to 180°, Ø 8–22 mm (5/16–7/8")

For accurate bending up to 180° on pipes made of:

**Copper (soft, semi-hard, hard thin-walled):**

Ø 8–22 mm (5/16–7/8")

**Copper (coated, also thin-walled):** Ø 10–18 mm (3/8–5/8")

**Aluminium and brass:** Ø 8–22 mm (5/16–7/8")

**Precision steel (also coated):** Ø 10–22 mm (3/8–5/8")

**Seamless stainless steel:** Ø 8–22 mm (5/16–7/8")



### Application Benefits

- Accurate bending on continuous pipe
- Form and pressure stable
- Free-hand bending with additional lever up to Ø 18 mm (5/8")  
Eliminates costs of bending fittings, procurement and warehousing
- Simple bending by clamping in the vice
- Precision bending with minimum size chart and bending angle display directly on the tool

Model	Weight	PU	No.
ROBEND H+W Plus set, 1/2–5/8–7/8"	13.700 kg	1	24504
ROBEND H+W Plus set, 10–12–14–16 mm	16.300 kg	1	24501
ROBEND H+W Plus set, 12–14–16–18 mm	13.600 kg	1	24502
ROBEND H+W Plus set, 12–15–18–22 mm	16.500 kg	1	24500
ROBEND H+W Plus set, 15–18–22 mm	14.900 kg	1	24505

## ROLUB Anti-Block special gliding shoe

Especially adapted to the ROBEND H+W PLUS bender the ROLUB guide shoe with two-point lubricating chamber system

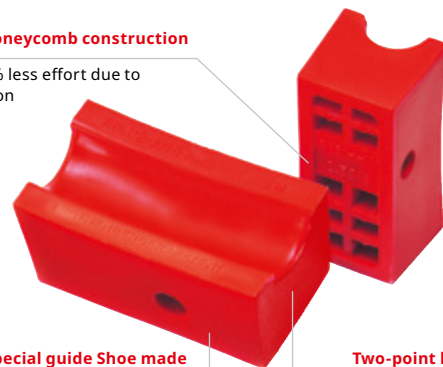
For copper pipe DIN EN 1057/12735-1/13348, aluminum / precision steel pipe DIN 2391/93/94, stainless steel pipe and others

### Application Benefits

- Original spare part from ROTHENBERGER
- ROLUB technology for a wrinkle-free bending results

Elastic honeycomb construction

Up to 42% less effort due to less friction



ROLUB special guide Shoe made of high-quality polyamide

Perfect bending results without friction marks

Two-point lubricating chamber system

Ensures optimum distribution of lubrication

Model	Weight	PU	No.
8 mm (5/16")	0.020 kg	1	25308
10 mm (3/8")	0.020 kg	1	25310
12 mm	0.030 kg	1	25312
14 mm	0.030 kg	1	25314
15 mm	0.030 kg	1	25315

Model	Weight	PU	No.
16 mm (5/8")	0.050 kg	1	25316
18 mm	0.050 kg	1	25318
22 mm (7/8")	0.090 kg	1	25322
1/2"	0.030 kg	1	25313
3/4"	0.090 kg	1	25319



### Accessories

	No.
Handle bar for ROBEND H+W Plus, 8mm (3/8")	25075
Handle bar ROBEND H+W Plus, 10–15 mm	25076
Robend H+W Handle (18–22 mm)	25078
Bending spray 150 ml	25120
ROCASE 6414 red without clip for user manual	1300003542

**ROBULL type E**

**For precise, manual hydraulic cold bending up to 90°**

Broadly applicable, universal portable hydraulic bending system for plumbing, sanitary and heating installation on construction sites, for apparatus and boiler construction and for industrial use. Also suitable for aligning tubes.

**ROBULL type E:**

For accurate bending up to 90° on pipes made of:

**Carbon steel suitable for welding and thread-cutting:**  
 Ø 3/8–2"



**Application Benefits**

- Precise bending with the angle scale on the support brackets
- Reduces welded joints
- No pre-warming of pipe is required
- No bending forms needed
- Works quicker with the 150 kN piston strength
- Easy and simple operation
- Closed, low-maintenance hydraulic system with a mono-block design and with quick, automatic piston retraction
- Comfortable working position with the tripod stand (opt.)
- With foldable and adjustable bending frame

3



**Optional: tripod stand (No. 58182)**  
 Comfortable working position

**ROBULL type E with adjustable bending frame:** ROBULL hydraulic bending machine, open bending frame (No. 57981), 2 pins for frame (No.57979), support segment (No.57983), support segment with degree gradation (No. 57982), bending segment standard 90° in 3/8" (No. 57985), 1/2" (No. 57986), 3/4" (No. 57987), 1" (No. 57988), 1.1/4" (No. 57989), 1.1/2" (No. 57990), 2" (No. 57991), hydraulic oil 1 l (No. 58185), steel carrying case (No. 58206)

**ROBULL type E with foldable bending frame:** same scope of delivery as the ROBULL type E with adjustable bending frame but with foldable bending frame (No. 58002)

Model	Weight	PU	No.
ROBULL type E without accessories	16.800 kg	1	057950X
ROBULL type E with adjustable bending frame and accessories, 3/8–2"	59.800 kg	1	057966X
ROBULL type E with foldable bending frame and accessories, 3/8–2"	72.600 kg	1	057961X

**ROBULL type E**



ROBULL type E with foldable bending frame



Fig. similar

**Bending segment for ROBULL type E**

**Small bending radius (red)**

For bending steel pipes according to DIN EN 10255



Model	Weight	PU	No.
3/8", wall thickness 2.35 mm, R 45 mm	0.700 kg	1	57985
1/2", wall thickness 2.65 mm, R 49 mm	0.700 kg	1	57986
3/4", wall thickness 2.65 mm, R 65 mm	0.800 kg	1	57987
1", wall thickness 3.25 mm, R 89 mm	1.300 kg	1	57988
1.1/4", wall thickness 3.25 mm, R 115 mm	1.600 kg	1	57989
1.1/2", wall thickness 3.25 mm, R 137 mm	2.400 kg	1	57990
2", wall thickness 3.65 mm, R 200 mm	3.200 kg	1	57991

**Bending segment for ROBULL type E**

**Large bending radius (black)**

For bending steel pipes according to DIN EN 10255



Model	Weight	PU	No.
3/8", wall thickness 2.35 mm, R 56 mm	0.800 kg	1	58010
1/2", wall thickness 2.35 mm, R 85 mm	0.900 kg	1	58011
3/4", wall thickness 2.65 mm, R 115 mm	1.200 kg	1	58012
1", wall thickness 2.65 mm, R 145 mm	2.100 kg	1	58013
1.1/4", wall thickness 3.25 mm, R 214 mm	3.500 kg	1	58014
1.1/2", wall thickness 3.25 mm, R 214 mm	4.300 kg	1	58015
2", wall thickness 3.65 mm, R 245 mm	5.600 kg	1	58016



Accessories	No.
Bending frame for all ROBULL, open, 2"	57981
Side shape, w. grade division, open, ROBULL E/ME	775004000
Side shape, w/o grade classific., open, ROBULL E/ME	57983
Side shape, w. degree div., foldable ROBULL E/ME	775504100

Accessories	No.
Locking pin	57979
Hydraulic oil, 1 l	58185
Tripartite for ROBULL type E/ME, collapsible	58182
Steel case	996277400

**ROBULL type ME**

**For precise, power hydraulic cold bending up to 90°**

Various uses, mobile hydraulic bending machine for use on the building site in gas, sanitary and heating installations.

**ROBULL type ME:**

For accurate bending up to 90° on pipes made of:

**Carbon steel suitable for welding and thread-cutting:**  
 Ø 3/8–2"



**Application Benefits**

- Precise bending with the angle scale on the support segments
- Reduces welding joints
- Pre-warming of the pipe no longer necessary
- No bending forms are necessary
- Effective use with the 150 kN piston strength
- Easy and simple operation
- Closed, low-maintenance hydraulic system with a monoblock design and with quick, automatic piston retraction
- Comfortable working position with the tripod stand (optional)
- With foldable and adjustable bending frame

3



**Optional: Tripod stand (No. 58182)**

Comfortable working position

**ROBULL type ME with adjustable bending frame:** ROBULL hydraulic bending machine 230 V, adjustable bending frame (No. 57981), 2 locking pins (No. 57979), support segments (No. 57983), support segments with degree gradation (No. 57982), bending segments standard 90° in 3/8" (No. 57985), 1/2" (No. 57986), 3/4" (No. 57987), 1" (No. 57988), 1.1/4" (No. 57989), 1.1/2" (No. 57990), 2" (No. 57991), hydraulic oil 1 l (No. 58185), steel carrying case (No. 58206)

**ROBULL type ME with foldable bending frame:** same scope of delivery as ROBULL type ME with adjustable bending frame but with foldable bending frame (No. 58002)

Model	Weight	PU	No.
ROBULL type ME with foldable bending frame and accessories, 3/8–2"	72.600 kg	1	057972X
ROBULL type ME with adjustable bending frame and accessories, 3/8–2"	59.800 kg	1	057973X
ROBULL type ME without accessories	17.800 kg	1	057969X

**ROBULL type ME**



ROBULL type ME with foldable bending frame



Fig. similar

**Bending segment for ROBULL type E**

**Small bending radius (red)**

For bending steel pipes according to DIN EN 10255



Model	Weight	PU	No.
3/8", wall thickness 2.35 mm, R 45 mm	0.700 kg	1	57985
1/2", wall thickness 2.65 mm, R 49 mm	0.700 kg	1	57986
3/4", wall thickness 2.65 mm, R 65 mm	0.800 kg	1	57987
1", wall thickness 3.25 mm, R 89 mm	1.300 kg	1	57988
1.1/4", wall thickness 3.25 mm, R 115 mm	1.600 kg	1	57989
1.1/2", wall thickness 3.25 mm, R 137 mm	2.400 kg	1	57990
2", wall thickness 3.65 mm, R 200 mm	3.200 kg	1	57991

**Bending segment for ROBULL type E**

**Large bending radius (black)**

For bending steel pipes according to DIN EN 10255



Model	Weight	PU	No.
3/8", wall thickness 2.35 mm, R 56 mm	0.800 kg	1	58010
1/2", wall thickness 2.35 mm, R 85 mm	0.900 kg	1	58011
3/4", wall thickness 2.65 mm, R 115 mm	1.200 kg	1	58012
1", wall thickness 2.65 mm, R 145 mm	2.100 kg	1	58013
1.1/4", wall thickness 3.25 mm, R 214 mm	3.500 kg	1	58014
1.1/2", wall thickness 3.25 mm, R 214 mm	4.300 kg	1	58015
2", wall thickness 3.65 mm, R 245 mm	5.600 kg	1	58016



Accessories	No.
Bending frame for all ROBULL, open, 2"	57981
Side shape, w. grade division, open, ROBULL E/ME	775004000
Side shape, w/o grade classific., open, ROBULL E/ME	57983
Side shape, w. degree div., foldable ROBULL E/ME	775504100

Accessories	No.
Locking pin	57979
Hydraulic oil, 1 l	58185
Tripartite for ROBULL type E/ME, collapsible	58182
Steel case	996277400

## Bending

### Bending machines

#### ROBEND 4000 E

**Electrical bending machine for bending pipes with  
Ø 12–35 mm (1/2–1.3/8")**

Universal application in sanitary and heating installations, in pipeline construction, refrigeration and air-conditioning systems as well as industrial systems and batch production. Fewer joints means less potential for leaks. Safety implies less likelihood of injury.

Suitable for pipes made of:

**Copper (hard, semi-hard and soft DIN EN 1057, 12735-1, 13348):**  
Ø 12–35 mm, (1/2–1.3/8")

**Copper and precision steel (coated):**  
Ø 12–28 mm, (1/2–1.1/8")

**Precision steel (soft DIN 2391 / 2393 / 2394):**  
Ø 12–28 mm, (1/2–1.1/8")

**Threaded steel (DIN 2440 / 2441):**  
Ø 1/2", 3/4"

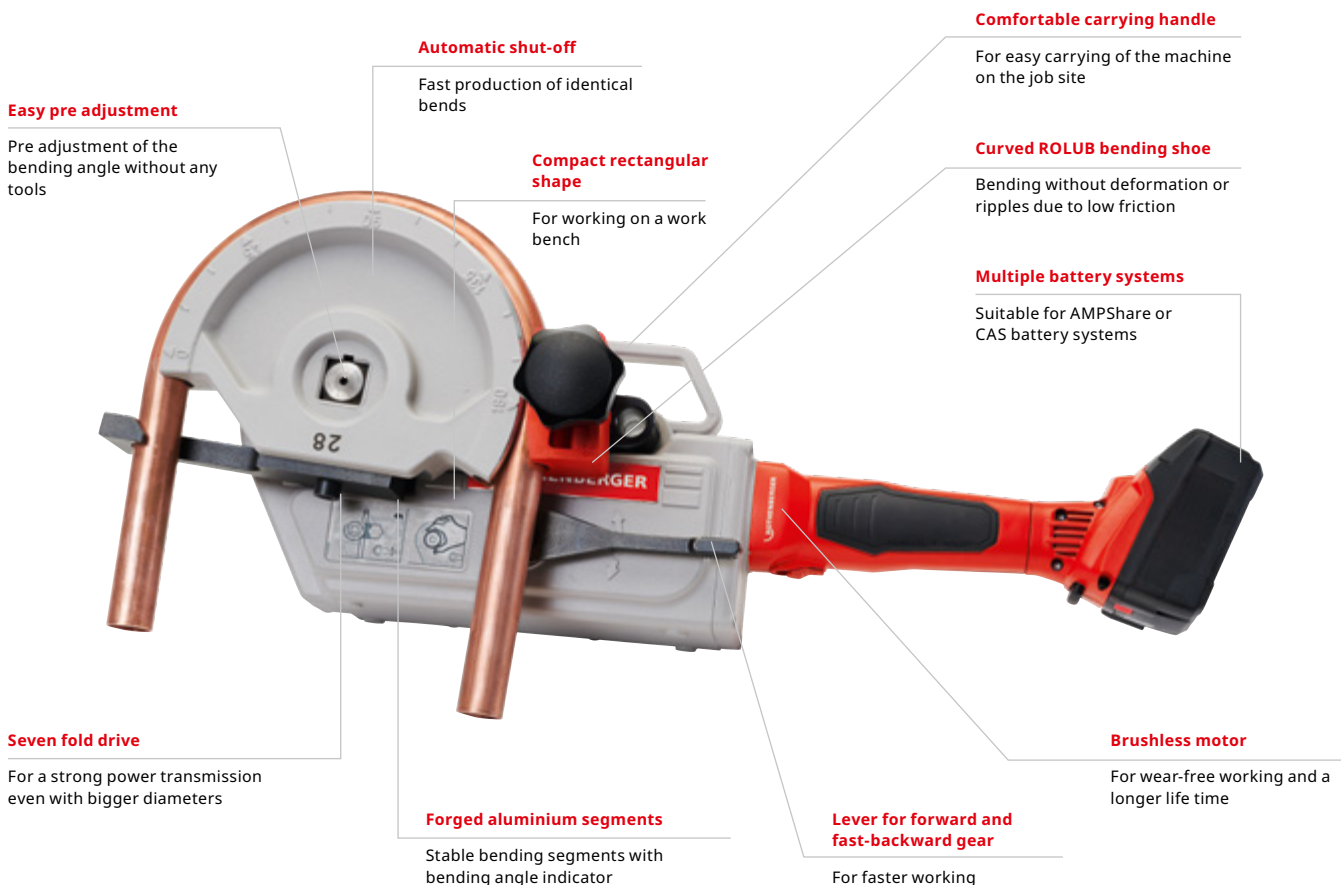
**Seamless stainless steel (GW 541):**  
Ø 12–28 mm, (1/2–1.1/8")



#### Application Benefits

- Quick return on investment through the savings from joints, soldering material and energy
- Universal application: U-bends, counter-bends, swan-neck bends and connecting bends possible at all levels
- Retains shape and remains stable: bending formers made of high-quality forged aluminium
- Top-quality, precise and simple to use
- Bending without deformation or ripples due to less friction

Available in the manufacturer-independent battery systems AMPShare – Powered by Bosch or CAS – CORDLESS ALLIANCE SYSTEM



**ROBEND 4000 E**

Model	Weight	PU	AMPSHare-No.	CAS-No.
ROBEND 4000 E set 1 × 4 Ah battery, 1/2-5/8-3/4-7/8-1.1/8"	29.450 kg	1	1000004193	1000003394
ROBEND 4000 E set 1 × 4 Ah battery, 12-14-16-18-22-28 mm	30.150 kg	1	1000004192	1000003393
ROBEND 4000 E bare tool without battery and charger	17.450 kg	1	1000004190	1000003391
ROBEND 4000 E set 1 × 4 Ah battery, 15-18-22-28 mm	29.150 kg	1	1000004191	1000003392

3



Forged aluminium segments with bending angle scale



Comfortable carry handle



Working with a Tripod



Compact, rectangular shape

## Bending

### Bending machines

#### ROBEND 4000

**Portable, sturdy and powerful. The successor of the proven ROBEND 3000, now with a higher bending capacity. Cold bending up to 180°, Ø 12-35 mm (1/2-1.3/8")**

Universal application in sanitary and heating installations, in pipeline construction, refrigeration and air-conditioning systems as well as industrial systems and batch production. Fewer joints means less potential for leaks. Safety implies less likelihood of injury.

Suitable for pipes made of:

**Copper (hard, semi-hard and soft DIN EN 1057, 12735-1, 13348):**  
Ø 12-35 mm, 1/2-1.3/8"

**Copper and precision steel (coated):**  
Ø 12-28 mm, (1/2-1.1/8")

**Precision steel (soft DIN 2391 / 2393 / 2394):**  
Ø 12-28 mm, (1/2-1.1/8")

**Threaded steel (DIN 2440 / 2441):**  
Ø 1/2", 3/4"

**Seamless stainless steel (GW 541):**  
Ø 12-28 mm, (1/2-1.1/8")

#### Application Benefits

- Quick return on investment through the savings from joints, soldering material and energy
- Universal application: U-bends, counter-bends, swan-neck bends and connecting bends possible at all levels
- Retains shape and remains stable: bending formers made of high-quality forged aluminium
- Top-quality, precise and simple to use
- Bending without deformation or ripples due to less friction
- Motor rating: 1,010W



#### Technical Data

Voltage	230 V
Working area diameter	1/2-1.3/8"
Working area diameter	12-35 mm
Output power	1,010 W
Power cable length	300 cm

3



**Forged aluminium former with bending radius scale**

Easy to use

**Pre adjustment of the bending angle without any tools**

Fast and precise bending

**ROLUB special guide shoe**

Bending without deformation or ripples due to less friction

**High-performance 1,010 W motor**

Ideal for continuous operation

#### Bending technology

Simplified work preparation, eliminates costs of purchase and storage of fittings

**Automatic switch-off when preset bending angle is obtained**

Fast batch production possible



**ROBEND 4000**

Model	Weight	PU	No.
ROBEND 4000 bare tool in carrying case without bending segments	14.500 kg	1	1000001559
ROBEND 4000 set 12-14-16-18-22 mm	21.900 kg	1	1000001551
ROBEND 4000 set 12-14-16-18-22-28 mm	24.100 kg	1	1000001552
ROBEND 4000 set 12-15-18-22-28 mm	23.500 kg	1	1000001549
ROBEND 4000 set 15-18-22 mm	24.120 kg	1	1000001554
ROBEND 4000 set 15-18-22-28mm	24.120 kg	1	1000001550
ROBEND 4000 set 15-18-22-28-35 mm	29.000 kg	1	1000001738
ROBEND 4000 set 15-18-22-28-32-35 mm	32.000 kg	1	1000001567
ROBEND 4000 set 15-22-28 mm	21.100 kg	1	1000001545
ROBEND 4000 set 1/2-5/8-3/4-7/8"	19.600 kg	1	1000001553
ROBEND 4000 set 1/2-5/8-3/4-7/8-1.1/8-1.3/8"	29.000 kg	1	1000001565
ROBEND 4000 set 7/8-1.1/8-1.3/8"	22.000 kg	1	1000001566

3



Bending of pipes made of various materials possible



Seven-fold drive



Comfortable carry handle



ROBEND 4000 with tripod stand

**ROBEND 4000 / 4000 E bending sets**

For bending pipes Ø 12-35 mm (1/2-1.3/8")

For steel pipe DIN 2440 and DIN 2441 (except 3/4")



Fig. ROBEND 4000/4000 E bending set with ROLUB special guide shoe

Model	Weight	PU	No.
Bending set for ROBEND 4000/4000 E Fe 1/2"	1.420 kg	1	25684
Bending set for ROBEND 4000/4000 E Fe 3/4"	2.900 kg	1	25685

For copper pipe DIN EN 1057, 12735-1, precision steel pipe DIN 2391/93/94, stainless steel pipe and others

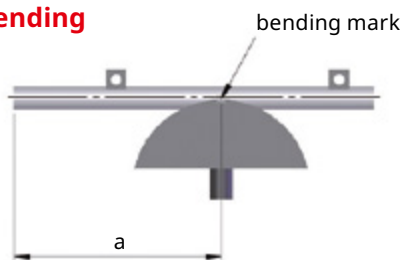
Model	Weight	PU	No.
Bending set for ROBEND 4000/4000 E 12 mm	0.480 kg	1	25612
Bending set for ROBEND 4000/4000 E 14 mm	0.480 kg	1	25614
Bending set for ROBEND 4000/4000 E 15 mm	0.530 kg	1	25615
Bending set for ROBEND 4000/4000 E 16 mm	0.600 kg	1	25616
Bending set for ROBEND 4000/4000 E 18 mm	1.170 kg	1	25618
Bending set for ROBEND 4000/4000 E 20 mm	1.420 kg	1	25620
Bending set for ROBEND 4000/4000 E 22 mm	1.420 kg	1	25622
Bending set for ROBEND 4000/4000 E 28 mm	2.900 kg	1	25628
Bending set for ROBEND 4000/4000 E 32 mm	3.400 kg	1	1000001561
Bending set for ROBEND 4000/4000 E 35 mm	3.600 kg	1	1000001563

For imperial copper pipe DIN EN 1057, 12735-1, precision steel pipe DIN 2391/93/94, stainless steel pipe and others

Model	Weight	PU	No.
Bending set for ROBEND 4000/4000 E 1/2"	0.530 kg	1	25652
Bending set for ROBEND 4000/4000 E 3/4"	1.420 kg	1	25619
Bending set for ROBEND 4000/4000 E 5/8"	0.600 kg	1	762955300
Bending set for ROBEND 4000/4000 E 7/8"	1.420 kg	1	762955700
Bending set for ROBEND 4000/4000 E 1"	2.900 kg	1	25625
Bending set for ROBEND 4000/4000 E 1.1/8"	2.900 kg	1	25626
Bending set for ROBEND 4000/4000 E 1.1/4" <sup>1</sup>	3.400 kg	1	1000001561
Bending set for ROBEND 4000/4000 E 1.3/8" <sup>1</sup>	3.600 kg	1	1000001563

1) Bending former sets (No. 1000001561 / No. 1000001563) are only compatible with ROBEND 4000 / ROBEND 4000 E. Only matching with optional plastic carrying case (No. 1000001564).

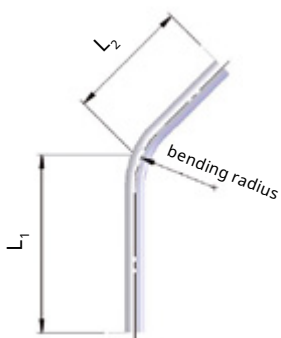
**Push bending**



**Symbols**

- $L_1, L_2$  = Leg length
- $a$  = Lay out length
- $L$  = Total length of the pipe piece
- $L_w$  = Distance / pipe end—wall
- $A_w$  = Distance / pipe middle—wall
- $L_M$  = Minimum length<sup>2</sup>
- $L_R$  = Reserve length<sup>2</sup>

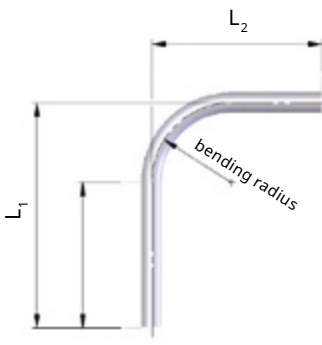
**45°-arc**



$$L = L_1 + L_2$$

$$a = L_1 + L_R$$

**90°-arc**



$$L = L_1 + L_2 - L_M$$

$$a = L_1 - L_R$$

2) All sizes listed are standards and are dependant on the material and the wall thickness. Bending specific sizes based on the bending radius tabular value.

**Calculation examples TUBE BENDER MAXI**

**Specifications:**

Installation in corner areas

$L_w = 1,200$  mm

$A_w = 30$  mm

Pipe-Ø 12 mm, 90°-arc

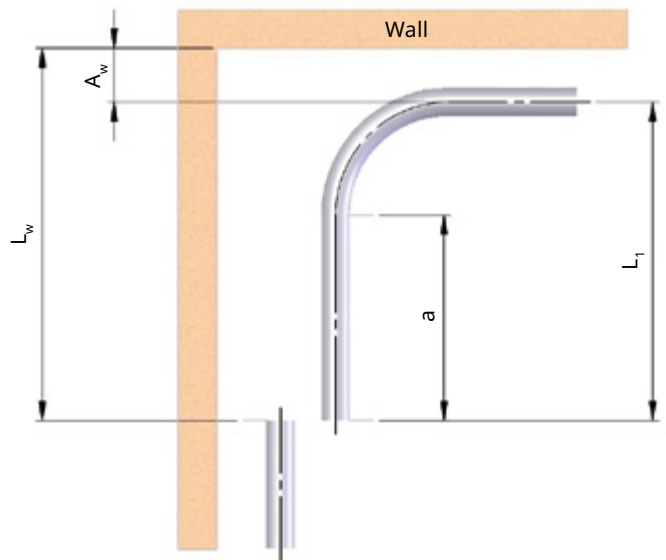
**Sought after:**

Leg length  $L_1$

Applied size a

**Solution:**

Summary from the TUBE BENDER MAXI bending table



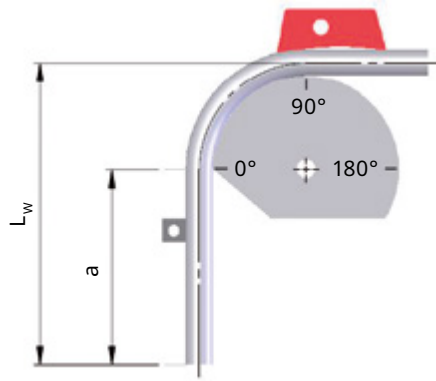
**Leg length**  $L_1 = L_w - A_w = 1,200 - 30 = 1,170$  mm  
**Applied size**  $a = L_1 - L_R = 1,170 - 7.5 = 1,162.5$  mm;  $L_R$  ... Tabular value

TUBE BENDER		at 45°		at 90°		at 180°	
for Ø mm / inch	Bending radius R (mm)	Reserve length $L_R$ mm	Minimum length $L_M$ mm	Reserve length $L_R$ mm	Minimum length $L_M$ mm	Reserve length $L_R$ mm	Minimum length $L_M$ mm
4.75 / 5"	20.0	4.5	1.0	4.5	10.0	—	—
6	23.5	5.0	1.2	5.0	11.5	—	—
8	28.0	7.0	1.4	7.0	14.0	—	—
9	30.0	7.0	1.5	7.0	15.0	—	—
10	34.0	7.5	1.8	7.5	17.5	—	—
12	37.5	8.5	1.9	8.5	19.0	—	—
3/16"	20.0	4.5	1.0	4.5	10.0	—	—
1/4"	23.5	5.0	1.2	5.0	11.5	—	—
5/16"	28.0	7.0	1.4	7.0	14.0	—	—
3/8"	34.0	7.5	1.8	7.5	17.5	—	—
1/2"	37.5	8.5	1.9	8.5	19.0	—	—

TUBE BENDER MAXI		at 45°		at 90°		at 180°	
for Ø mm / inch	Bending radius R (mm)	Reserve length $L_R$ mm	Minimum length $L_M$ mm	Reserve length $L_R$ mm	Minimum length $L_M$ mm	Reserve length $L_R$ mm	Minimum length $L_M$ mm
12	35.0	0.8	10.0	7.5	35.5	—	—
14	42.5	0.9	12.5	9.0	42.5	—	—
15	48.5	1.1	14.0	10.5	48.5	—	—
16	49.0	1.1	14.5	10.5	49.0	—	—
18	74.0	1.7	22.0	16.0	74.0	—	—
22	87.0	1.9	22.5	18.5	87.0	—	—
3/8"	35.0	0.8	10.0	7.5	35.0	—	—
1/2"	35.0	0.8	10.0	7.5	35.0	—	—
5/8"	49.0	1.1	14.5	10.5	49.0	—	—
3/4"	74.0	1.7	22.0	16.0	74.0	—	—
7/8"	87.0	1.9	25.5	18.5	87.0	—	—

TUBE BENDER MAXI CT		at 45°		at 90°		at 180°	
Tube Ø $W_s$ mm	Bending radius R (mm)	Reserve length $L_R$ mm	Minimum length $L_M$ mm	Reserve length $L_R$ mm	Minimum length $L_M$ mm	Reserve length $L_R$ mm	Minimum length $L_M$ mm
10 × 0.6	42.5	0.8	12.5	9.0	42.5	—	—
12 × 0.6	49.0	1.1	14.5	10.5	49.0	—	—
15 × 0.7	74.0	1.7	22.0	16.0	74.0	—	—
18 × 0.7	87.0	1.9	25.5	18.5	87.0	—	—

**Pull bending**



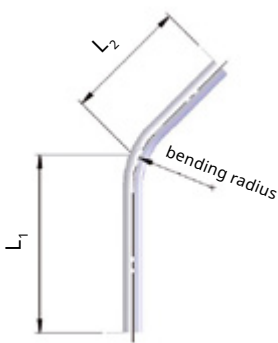
**Symbols**

- $L_1$   $L_2$  = Leg length
- $a$  = Lay out length
- $L$  = Total length of the pipe piece
- $L_w$  = Distance / pipe end—wall
- $A_w$  = Distance / pipe middle—wall
- $L_M$  = Minimum length<sup>1</sup>
- $L_R$  = Reserve length<sup>1</sup>

**45°-arc**

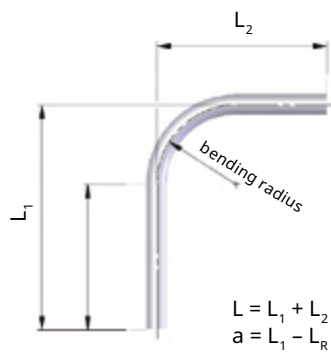
**90°-arc**

**180°-arc**



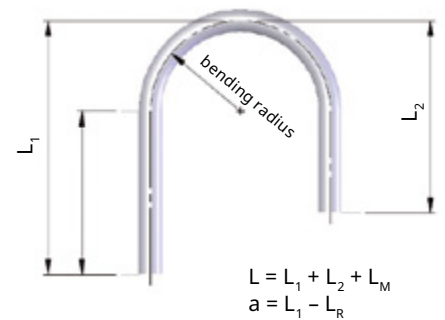
$$L = L_1 + L_2$$

$$a = L_1 + L_R$$



$$L = L_1 + L_2 - L_M$$

$$a = L_1 - L_R$$



$$L = L_1 + L_2 + L_M$$

$$a = L_1 - L_R$$

**Calculation examples  
ROBEND 4000 / ROBEND 4000 E**

**Specifications:**

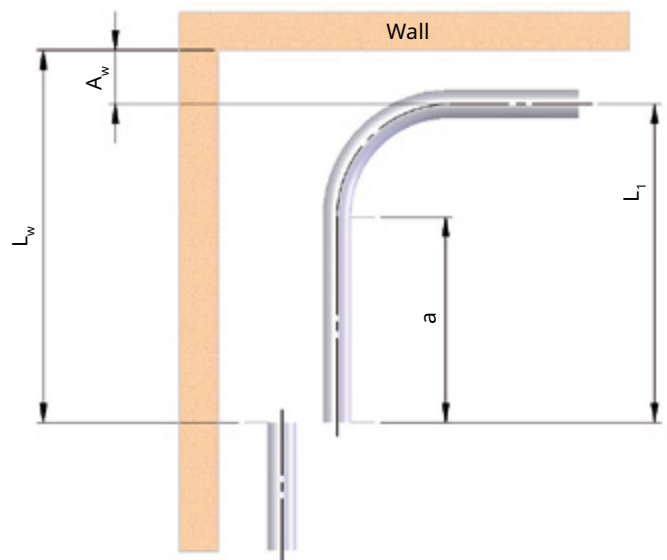
Installation in corner areas  
 $L_w = 1,200$  mm  
 $A_w = 30$  mm  
 Pipe-Ø 12 mm, 90°-arc

**Sought after:**

Leg length  $L_1$   
 Applied size  $a$

**Solution:**

Summary from the ROBEND 4000 / ROBEND 4000 E



**Leg length**  $L_1 = L_w - A_w = 1,200 - 30 = 1,170$  mm

**Applied size**  $a = L_1 - L_R = 1,170 - 42 = 1,128$  mm;  $L_R$  ... Tabular value

<b>ROBEND H+W PLUS</b>		at 45°		at 90°		at 180°	
for Ws mm / inch	Bending radius R (mm)	Reserve length L <sub>R</sub> mm	Minimum length L <sub>M</sub> mm	Reserve length L <sub>R</sub> mm	Minimum length L <sub>M</sub> mm	Reserve length L <sub>R</sub> mm	Minimum length L <sub>M</sub> mm
8	22	9	—	22	9.5	22	47
10	32	12	—	32	15.0	32	34
12	38	15	—	40	20.0	38	39
14	45	17	—	44	22.0	44	51
15	45	17	—	44	22.0	44	51
16	64	25	—	67	30.0	68	65
18	64	25	—	67	30.0	68	65
20	81	30	—	85	40.0	86	83
22	81	30	—	85	40.0	86	83
5/16"	22	9	—	22	9.5	22	47
3/8"	32	12	—	32	20.0	32	34
1/2"	38	15	—	40	22.0	38	39
5/8"	64	25	—	67	30.0	68	65
3/4"	81	30	—	85	40.0	86	83
7/8"	81	30	—	85	40.0	86	83

<b>MINIBEND</b>		at 45°		at 90°		at 180°	
for Ws mm / inch	Bending radius R (mm)	Reserve length L <sub>R</sub> mm	Minimum length L <sub>M</sub> mm	Reserve length L <sub>R</sub> mm	Minimum length L <sub>M</sub> mm	Reserve length L <sub>R</sub> mm	Minimum length L <sub>M</sub> mm
6	25.0	10.4	1.0	22.0	10.0	22.0	26.0
8	24.0	9.9	1.0	32.0	15.0	32.0	34.0
10	23.0	9.5	1.0	32.0	15.0	32.0	34.0
1/4"	25.0	10.4	1.0	22.0	10.0	22.0	26.0
5/16"	24.0	9.9	1.0	32.0	15.0	32.0	34.0
3/8"	23.0	9.5	1.0	32.0	15.0	32.0	34.0

<b>Standard bender 180°</b>		at 45°		at 90°		at 180°	
for Ø mm / inch	Bending radius R (mm)	Reserve length L <sub>R</sub> mm	Minimum length L <sub>M</sub> mm	Reserve length L <sub>R</sub> mm	Minimum length L <sub>M</sub> mm	Reserve length L <sub>R</sub> mm	Minimum length L <sub>M</sub> mm
6	18.0	7.0	0.8	18.5	8.0	18.5	20.0
10	30.0	11.5	1.3	30.5	14.5	30.5	34.0
12	36.0	14.0	1.5	36.5	15.0	36.5	37.5
14	47.5	18.5	2.0	48.5	20.5	48.5	52.5
15	54.0	21.0	2.3	56.0	24.5	56.0	58.0
16	58.0	22.5	2.5	64.0	28.5	64.0	67.0
18	66.0	25.5	2.8	68.0	31.0	68.0	72.0
1/4"	18.0	7.0	0.8	18.5	8.0	18.5	20.0
5/6"	24.0	9.5	1.0	24.0	12.0	24.0	27.0
1/2"	42.0	16.5	1.8	49.5	22.5	49.5	53.0
5/8"	58.0	22.5	2.5	64.0	28.5	64.0	67.0

<b>MULTIBEND</b>		at 45°		at 90°		at 180°	
for Ø mm / inch	Bending radius R (mm)	Reserve length L <sub>R</sub> mm	Minimum length L <sub>M</sub> mm	Reserve length L <sub>R</sub> mm	Minimum length L <sub>M</sub> mm	Reserve length L <sub>R</sub> mm	Minimum length L <sub>M</sub> mm
8	24.0	9.5	1.0	24.0	10.0	24.0	26.0
10	30.0	12.0	1.3	30.5	14.5	30.5	32.5
12	36.0	14.0	1.5	36.5	15.5	36.5	37.5
14	42.0	16.5	1.8	42.0	19.5	42.5	44.0
15	48.0	19.0	2.0	48.0	22.0	48.0	53.0
16	48.0	19.0	2.0	48.0	22.0	48.0	53.0
18	54.0	21.0	2.3	54.0	26.0	54.5	58.0





<b>ROBEND 4000 / 4000 E</b>			at 45°		at 90°		at 180°	
for Ø mm / inch	Pipe	Bending radius R (mm)	Reserve length L <sub>R</sub> mm	Minimum length L <sub>M</sub> mm	Reserve length L <sub>R</sub> mm	Minimum length L <sub>M</sub> mm	Reserve length L <sub>R</sub> mm	Minimum length L <sub>M</sub> mm
12		42.0	16	—	42	24	42	68
14	wated	52.5	21	—	53	30	53	87
15		52.5	21	—	53	30	53	87
17	wated	72.0	28	—	72	41	72	107
18		72.0	28	—	72	41	72	107
20	wated	88.5	35	—	89	51	89	121
22		88.0	35	—	88	50	88	119
24	wated	112.0	43	—	110	62	110	144
28		112.0	44	—	112	64	112	148
30	wated	112.0	45	—	114	66	114	152
32 / 1.1/4"		128.0	52	—	140	70	135	140
35 / 1.3/8"		140.0	55	—	150	80	145	150
3/8"	steel	12.0	31	—	80	46	80	103
1/2"	copper	45.0	18	—	45	26	45	74
1/2"	steel	88.0	35	—	88	50	88	119
5/8"	copper	56.0	23	—	56	32	56	93
3/4"	steel	112.0	43	—	112	64	112	148
3/4"	copper	80.0	31	—	80	46	80	103
7/8"	copper	88.0	35	—	88	50	88	119
1"	copper	112.0	44	—	112	64	112	148
1.1/8"	copper	112.0	45	—	114	66	114	152



## Expanding, extracting and flaring



<b>System overview</b>	<b>96-97</b>
Expanding manual	98-104
Expanding hydraulic	105-106
Accessories expanding	107
Expanding and extracting manual	108
Extracting manual	109-111
Accessories extracting manual	112
Flaring	113-116
Torque wrench	117

Expander				
	ROLOCK expander power torque	Expander A0	Step expander A1	H 600
				
Operation mode	Manual	Manual	Manual	Hydraulic
Working range Copper	Ø 8–42 mm (5/16–1.3/4") Wall thickness 1.6 mm soft, semi-hard	Ø 22–67 mm (1–2.1/2") Wall thickness 2.5 mm soft, semi-hard	Ø 35–108 mm (1.3/8–4.1/8") Wall thickness 2.5 mm soft	Ø 8–110 mm (5/16–4.1/4") Wall thickness 3 mm soft, semi-hard
Working range Aluminium	Ø 8–28 mm (5/16–1.1/8") Wall thickness 1.6 mm soft	Ø 22–67 mm (1–2.1/2") Wall thickness 2.5 mm soft, semi-hard	Ø 35–108 mm (1.3/8–4.1/8") Wall thickness 2.5 mm soft	Ø 8–110 mm (5/16–4.1/4") Wall thickness 3 mm soft, semi-hard
Working range Precision steel	Ø 8–28 mm (5/16–1.1/8") Wall thickness 1.6 mm soft	Ø 22–54 mm (1–2.1/8") Wall thickness 1.5 mm soft	○	Ø 8–110 mm (5/16–4.1/4") Wall thickness 3 mm soft, semi-hard
Working range Stainless steel	Ø 8–22 mm (5/16–7/8") Wall thickness 1 mm soft	Ø 22–54 mm (1–2.1/8") Wall thickness 1.5 mm soft	○	Ø 8–110 mm (5/16–4.1/4") Wall thickness 3 mm soft, semi-hard
Page	98	102	104	105

4



## Expander heads

**Expander head  
ROLOCK**

**Expander head  
standard**

**Expander head  
Typ S**

**Flanged riveted  
expander head**


Working range Copper	Ø 8–42 mm (5/16–1.3/4") Wall thickness 1.6 mm soft, semi-hard	Ø 8–42 mm (5/16–1.3/4") Wall thickness 1.6 mm soft, semi-hard	Ø 22–67 mm (1–2.1/2") Wall thickness 2.5 mm soft, semi-hard	Ø 15–38 mm Wall thickness 1.5 mm soft, semi-hard
Working range Aluminium	Ø 8–28 mm (5/16–1.1/8") Wall thickness 1.6 mm soft	Ø 8–28 mm (5/16–1.1/8") Wall thickness 1.6 mm soft	Ø 22–67 mm (1–2.1/2") Wall thickness 2.5 mm soft	○
Working range Precision steel	Ø 8–28 mm (5/16–1.1/8") Wall thickness 1.6 mm soft	Ø 8–28 mm (5/16–1.1/8") Wall thickness 1.6 mm soft	Ø 22–54 mm (1–2.1/8") Wall thickness 1.5 mm soft	○
Working range Stainless steel	Ø 8–22mm (5/16–7/8") Wall thickness 1 mm soft	Ø 8–22mm (5/16–7/8") Wall thickness 1 mm soft	Ø 22–54 mm (1–2.1/8") Wall thickness 1.5 mm soft	○
<b>Page</b>	<b>100</b>	<b>101</b>	<b>103</b>	<b>103</b>

### Step expander head



Working range Copper	Ø 35–108 mm (1.3/8–4.1/8") Wall thickness 2.5 mm soft
Working range Aluminium	Ø 35–108 mm (1.3/8–4.1/8") Wall thickness 2.5 mm soft
Working range Precision steel	○
Working range Stainless steel	○
<b>Page</b>	<b>104</b>

## ROLOCK expander power torque

For expanding, reducing and calibrating soft and semi-hard pipes Ø 8–42 mm (5/16–1.3/4") as well as producing tapers

For efficient, fitting-free installation of pipes in sanitary heating, gas, refrigeration and air-conditioning systems

Suitable for pipes made of:

**Copper (soft and semi-hard):**

Ø 8–42 mm, 5/16–1.3/4", max. wall thickness 1.6 mm

**Aluminium (soft):**

Ø 8–28 mm, 5/16–1.1/8", max. wall thickness 1.6 mm

**Precision steel (soft):**

Ø 8–28 mm, 5/16–1.1/8", max. wall thickness 1.6 mm

**Stainless steel (soft):**

Ø 8–22 mm, 5/16–7/8", max. wall thickness 1.0 mm



### EPT-Technology (Enclosed Power Transmission)

of the expander head offers the following technical benefits:

#### Concealed bent lever:

Protection against dirt and external mechanical damage

#### Energy efficient through optimised force transmission:

Ergonomic, highly optimised force flow in relation to the hand force of the user, therefore reducing effort

### Application Benefits

- Eliminates the cost of purchase and storage of fittings
- Converts deformed pipes into fittings, saves resources
- 50 % reduction of labour, soldering materials, joints and energy
- Reliable pipe connection according to DVGW standards
- Tough, light and wear-resistant
- Toolless fine adjustment of the capillary gap
- EPT-Technology—concealed bent lever

4



Toolless adjustment of expanding dimension and capillary gap

Twist and lock system for screwable and twist-lock heads

Long lever arms

Reduces effort required

Expanding

Up to 50% reduction in labour, soldering materials, joints and energy

Ergonomic handles

No slipping, no clamping



Steel receptacle

Twist and lock system: resilient and hardwearing

High-performance, forged aluminium body

Highweight, optimal handling

Extra long segments

Reliable pipe connection according to DVGW standards

### TiN Coating (Titanitrid-coating)

of the expander head offers the following technical benefits:

**High durability 2,300 HV:** Protection against abrasive wear

**Lower friction value compared to steel:** Less effort

**Good chemical resistance:** Good protection against corrosion

**Universal wear resistance:** Long-lasting

### Made in Germany

The know-how from the pioneer of expanding technology and the leading manufacturer of expanding tools for over 50 years!

Model	Weight	PU	No.
ROLOCK Expander Power Torque 8–42 mm (5/16–1.3/4")	1.000 kg	1	12400

## ROLOCK expander power torque sets



Model	Weight	PU	No.
10-12-14-16-18-22 mm	3.600 kg	1	12511
10-12-16-22-28 mm	3.280 kg	1	12505
10-12-15-16-18-22-28 mm	3.570 kg	1	12537
12-14-16-18-22 mm	3.300 kg	1	12509
12-15-18-22 mm	2.930 kg	1	12500
12-15-18-22-28 mm	3.385 kg	1	12503
12-16-18-22-28 mm	3.240 kg	1	12522
12-14-16-18-22-28-32 mm	3.700 kg	1	12538

For efficient, fitting-free installation of pipes



Model	Weight	PU	No.
12-15-18-22-28-35-42 mm	4.200 kg	1	12526
3/8-1/2-5/8-3/4-1"	3.325 kg	1	12517
3/8-1/2-5/8-3/4-7/8-1.1/8"	3.600 kg	1	12518
3/8-1/2-5/8-3/4-7/8-1-1.1/8"	3.700 kg	1	12536
3/8-1/2-5/8-3/4-7/8-1.1/8-1.3/8"	4.500 kg	1	12541
1/2-5/8-3/4-7/8"	2.900 kg	1	12521
1/2-3/4-1"	2.900 kg	1	12535
1/2-5/8-7/8-1.1/8"	3.000 kg	1	12524

## ROCAM PE-X expander power torque

For expanding and calibrating PE-X and aluminium multi-layered composite pipe (MLP) up to  $\varnothing 42$  mm or 1.3/4" as well as producing tapers

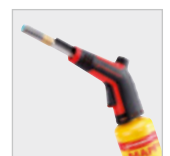
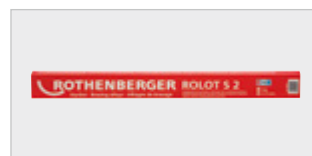
Expander heads coordinates with the following systems: ROTEX, SCHELL, TECE/TECEflex, Vulkan-Lokring among others

### Application Benefits

- Can be used for common systems from SCHELL, TECE, REHAU etc.
- Comfortable working due to long lever arms
- Sturdy construction for a long service life



Model	Weight	PU	No.
ROCAM Expander head PE-X	0.990 kg	1	12005



Accessories	Page
Expander heads for ROLOCK expander power torque	100
Expander heads type S / riveted expander heads	103
Pipe cutter	14
Internal / external deburrer	37

Accessories	Page
Expander adaptor type S	103
Brazing solder	199
High-performance torch (SUPER FIRE 4 with MAPP <sup>1</sup> gas)	172

1) MAPP is a registered trademark of the MESSER Group GmbH, Bad Soden

### Expander head ROLOCK

For producing standard precision flares  $\varnothing 8-42$  mm (5/16-1.3/4") according to DVGW standards as well as the specifications for the Gas de France

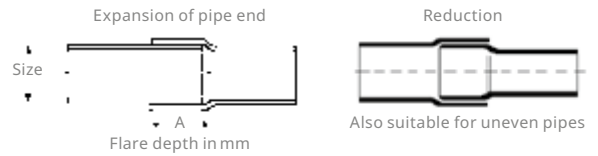
For expanding copper, stainless steel and aluminum pipes in sanitary/heating and refrigeration/air-conditioning technology

#### Application Benefits

- 50 % reduction in labour, soldering materials and soldered joints
- Depth of the flare is consistent with DVGW standards
- Compulsory guidance guarantees a perfect centred position and uniform capillary gap
- Robust and long lasting with the hardened segments

**Made in Germany**

The know-how from the pioneer of expanding technology and the leading manufacturer of expanding tools for over 50 years!



#### Specially hardened segments

Robust and long lasting

#### Step at the end of the segments

Enables recalibration of irregular pipes and fittings

#### 6 rivets and guide channels

Compulsory guidance guarantees a perfect centred position and uniform capillary gap

#### Extra long segments

Depth of the flare is consistent with DVGW standards



Ø mm	max. wall thickness mm				A-size mm	Weight	No.
	Cu	Al	Fe	INOX			
8	1.0	1.0	1.0	1.0	6.0	0.120 kg	12408
10	1.0	1.0	1.0	1.0	10.0	0.120 kg	12410
12	1.2	1.2	1.2	1.0	12.6	0.120 kg	12412
14	1.2	1.2	1.2	1.0	12.6	0.120 kg	12414
15	1.2	1.2	1.2	1.0	15.5	0.120 kg	12415
16	1.2	1.2	1.2	1.0	15.5	0.120 kg	12416
18	1.2	1.2	1.2	1.0	17.5	0.120 kg	12418
20	1.2	1.2	1.2	1.0	17.5	0.140 kg	12420
22	1.2	1.5	1.5	1.0	20.5	0.140 kg	12422
28	1.5	1.5	1.5		18.5	0.390 kg	12428
32	1.5				19.5	0.410 kg	12432
35	1.6				19.5	0.430 kg	12435
38	1.6				19.5	0.450 kg	12438
40	1.5				19.5	0.470 kg	12440
42	1.5				19.5	0.470 kg	12442

Ø Inch	max. wall thickness mm				A-size mm	Weight	No.
	Cu	Al	Fe	INOX			
5/16"	1.0	1.0	1.0	1.0	6.0	0.120 kg	12408
3/8"	1.0	1.0	1.0	1.0	7.4	0.120 kg	12452
1/2"	1.2	1.2	1.2	1.0	11.0	0.120 kg	12453
5/8"	1.2	1.2	1.2	1.0	14.0	0.120 kg	12454
3/4"	1.2	1.2	1.2	1.0	18.1	0.120 kg	12455
7/8"	1.2	1.2	1.2	1.0	18.0	0.140 kg	12456
1"	1.5	1.5	1.5		15.8	0.150 kg	12457
1.1/8"	1.6	1.6	1.6		17.0	0.390 kg	12458
1.1/4"	1.6				17.0	0.410 kg	12459
1.3/8"	1.6				17.0	0.430 kg	12435
1.1/2"	1.6				17.0	0.450 kg	12438
1.5/8"	1.6				17.5	0.470 kg	12462
1.3/4"	1.6				17.5	0.500 kg	12463

Availability, delivery time and price of custom products for other pipe diameters available upon request.

## Expander head standard

For producing standard precision flares  $\varnothing 8\text{--}42\text{ mm}$  (5/16–1.3/4") according to DVGW standards as well as the specifications for the Gas de France

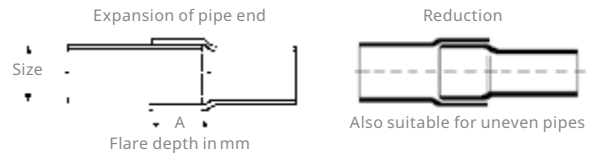
For expanding copper, stainless steel and aluminum pipes in sanitary/heating and refrigeration/air-conditioning technology

### Application Benefits

- 50 % reduction in labour, soldering materials and soldered joints
- Depth of the flare is consistent with DVGW standards
- Compulsory guidance guarantees a perfect centred position and uniform capillary gap
- Robust and long lasting with the hardened segments

### Made in Germany

The know-how from the pioneer of expanding technology and the leading manufacturer of expanding tools for over 50 years!



### Specially hardened segments

Robust and long lasting

### Step at the end of the segments

Enables recalibration of irregular pipes and fittings

### 6 rivets and guide channels

Compulsory guidance guarantees a perfect centred position and uniform capillary gap

### Extra long segments

Depth of the flare is consistent with DVGW standards



Ø mm	max. wall thickness mm				A-size mm	Weight	No.
	Cu	Al	Fe	INOX			
8	1.0	1.0	1.0	1.0	6.0	0.120 kg	11008
10	1.0	1.0	1.0	1.0	10.0	0.120 kg	11010
12	1.2	1.2	1.2	1.0	12.6	0.120 kg	11012
14	1.2	1.2	1.2	1.0	12.6	0.120 kg	11014
15	1.2	1.2	1.2	1.0	15.5	0.120 kg	11015
16	1.2	1.2	1.2	1.0	15.5	0.120 kg	11016
18	1.2	1.2	1.2	1.0	17.5	0.120 kg	11018
20	1.2	1.2	1.2	1.0	17.5	0.140 kg	11020
22	1.2	1.5	1.5	1.0	20.5	0.140 kg	11022
28	1.5	1.5	1.5		18.5	0.390 kg	11028
32	1.5				19.5	0.410 kg	11032
35	1.6				19.5	0.430 kg	11035
38	1.6				19.5	0.450 kg	11038
40	1.5				19.5	0.470 kg	11040
42	1.5				19.5	0.470 kg	11042

Ø Inch	max. wall thickness mm				A-size mm	Weight	No.
	Cu	Al	Fe	INOX			
5/16"	1.0	1.0	1.0	1.0	6.0	0.120 kg	11008
3/8"	1.0	1.0	1.0	1.0	7.4	0.120 kg	11052
1/2"	1.2	1.2	1.2	1.0	11.0	0.120 kg	11053
5/8"	1.2	1.2	1.2	1.0	14.0	0.120 kg	11054
3/4"	1.2	1.2	1.2	1.0	18.1	0.120 kg	11055
7/8"	1.2	1.2	1.2	1.0	18.0	0.140 kg	11056
1"	1.5	1.5	1.5		15.8	0.150 kg	11057
1.1/8"	1.6	1.6	1.6		17.0	0.390 kg	11058
1.1/4"	1.6				17.0	0.410 kg	11059
1.3/8"	1.6				17.0	0.430 kg	11035
1.1/2"	1.6				17.0	0.450 kg	11038
1.5/8"	1.6				17.5	0.470 kg	11062
1.3/4"	1.6				17.5	0.500 kg	11063

Availability, delivery time and price of custom products for other pipe diameters available upon request.

**Expander A0**

**For expanding, reducing and calibrating thick walled pipes Ø 22–67 mm (1–2.1/2") as well as the production of tapers**

For efficient, fitting-free installation of pipes in sanitary, heating, gas, refrigeration and air-conditioning systems

Suitable for pipes made of:

**Copper and aluminium (soft, semi-hard):**

Ø 22–67 mm, 1–2.1/2", max. wall thickness 2.5 mm

**Precision steel (soft) and stainless steel per DVGW-GW541:**

Ø 22–54 mm, 1–2.1/8", max. wall thickness 1.5 mm

**Application Benefits**

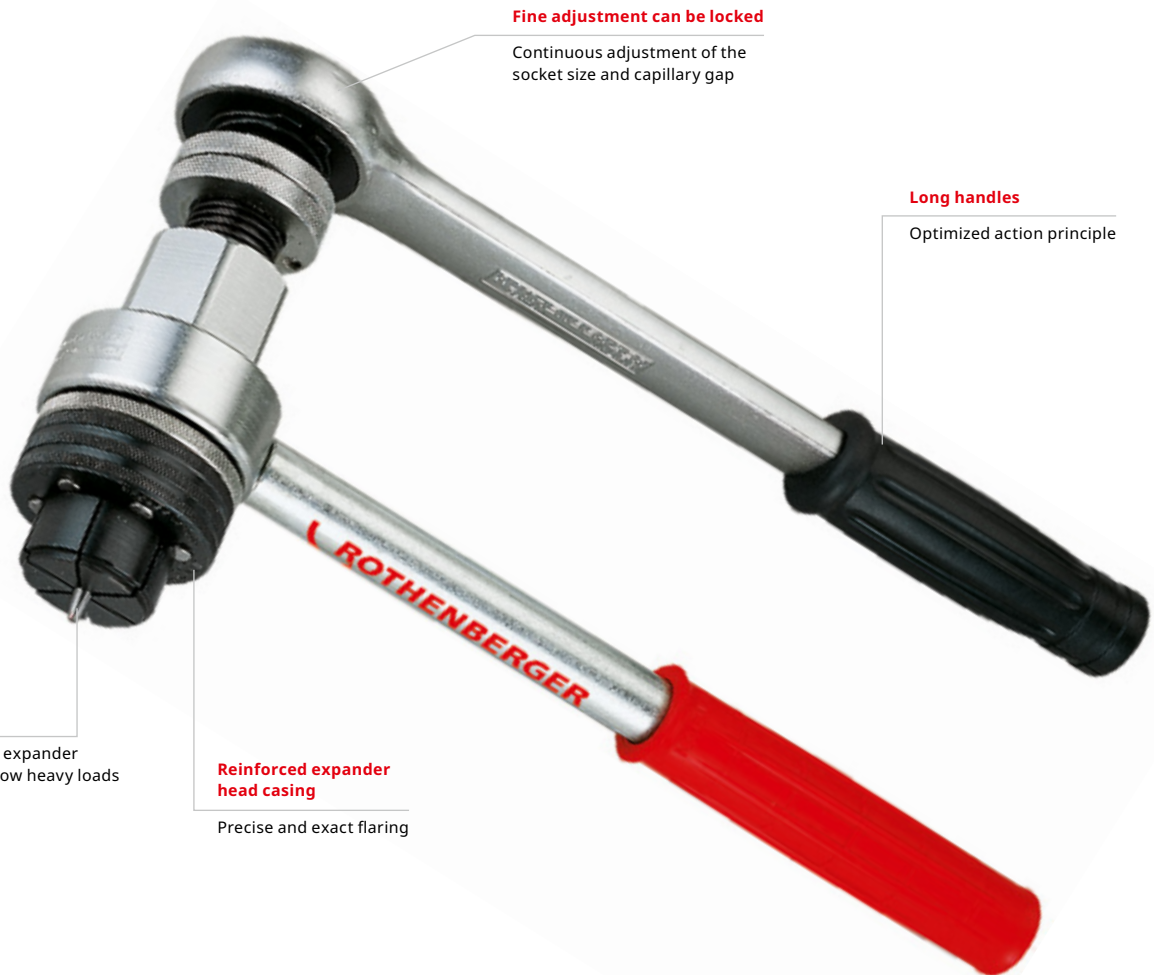
- Application and savings advantages similar to ROLOCK expander power torque
- Precise and exact flaring
- Full bearing of the expander head segments allows heavy loads
- Continuous adjustment of the socket size and capillary gap
- Optimized action principle with long handles

**Functional elements:**  
Expander A0 with a tightly guided and reinforced, long expander head, matches to the expander head type S!



Fig. similar

4



**Fine adjustment can be locked**

Continuous adjustment of the socket size and capillary gap

**Long handles**

Optimized action principle

**Strong pin guide**

Full bearing of the expander head segments allow heavy loads

**Reinforced expander head casing**

Precise and exact flaring

Expander A0 set (No. 11400) includes:  
expander head type S, special ratchet (No. 27181)

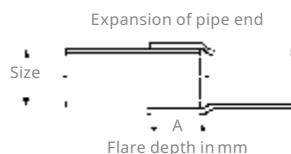
Expander A0 basic unit (No. 11004) includes:  
square drive mechanism 3/4" with handle, without expander head and ratchet

Model	Weight	PU	No.
Expander A0 bare tool	1.970 kg	1	11004
Expander A0 set 35–42–54–64 mm	8.120 kg	1	11400

### Expander head type S

For the precise expansion of normal and thick walled pipes  $\varnothing$  22–67 mm (1–2.1/2") and 2.5 mm wall thickness

Suitable for expanding copper, stainless steel and aluminium pipes in the plumbing, heating, refrigeration and air conditioning sector.



Ø mm	max. wall thickness mm				A-size mm	Weight	No.
	Cu	Al	Fe	INOX			
22	2.0	2.0	1.5	1.5	18.5	0.350 kg	11323
25	2.0	2.0	1.5	1.5	18.5	0.350 kg	11325
28	2.0	2.0	1.5	1.5	19.5	0.360 kg	11328
32	2.0	2.0	1.5	1.5	19.5	0.380 kg	11332
35	2.0	2.0	1.5	1.5	19.5	0.400 kg	11335
36	2.0	2.0	1.5	1.5	19.5	0.400 kg	11336
42	2.0	2.0	1.5	1.5	19.5	0.450 kg	11342
54	2.5	2.5	1.5	1.5	19.5	0.570 kg	11346
64	2.5	2.5			19.5	0.690 kg	11348
67	2.5	2.5			19.5	0.750 kg	11380

Ø Inch	max. wall thickness mm				A-size mm	Weight	No.
	Cu	Al	Fe	INOX			
1"	2.0	2.0	1.5	1.5	18.5	0.350 kg	11376
1.1/8"	2.0	2.0	1.5	1.5	19.5	0.360 kg	11358
1.1/4"	2.0	2.0	1.5	1.5	19.5	0.380 kg	11332
1.3/8"	2.0	2.0	1.5	1.5	19.5	0.400 kg	11335
1.5/8"	2.0	2.0	1.5	1.5	19.5	0.450 kg	11362
2"	2.0	2.0	1.5	1.5	17.0	0.540 kg	11364
2.1/8"	2.5	2.5	1.5	1.5	17.0	0.570 kg	11346
2.1/2"	2.5	2.5			17.0	0.690 kg	11348

### Expander adaptor type S

To increase the application area of the ROCAM / ROLOCK expander power torque, ROMAX expander compact standard and expander pistol H1

To extend the application range of the ROCAM, ROLOCK and H1 Expander.

Allows the use of the expander heads type S with copper pipe (soft) up to 67 mm and/or 2.1/2"!



Model	Weight	PU	No.
Adaptor type S without expander heads, 22–67 mm, (1–2.1/2")	0.630 kg	1	11007

### Flanged riveted expander heads

For use with the ROCAM / ROLOCK expander power torque, ROMAX expander compact standard and expander pistol H1

Perfect for creating precise hose connections inside units with constant vibrations in air-conditioning technology, car manufacturing or industrial applications.



Model	Weight	PU	No.
Flanged riveted expander head 15 mm	0.110 kg	1	11955
Flanged riveted expander head 18 mm	0.110 kg	1	11958
Flanged riveted expander head 22 mm	0.120 kg	1	11962
Flanged riveted expander head 28 mm	0.370 kg	1	11968
Flanged riveted expander head 38 mm	0.430 kg	1	11978

### Step expander A1

**For expanding, reducing and calibrating thick walled pipes, Ø 35-108 mm (1.3/8- 1.1/8") as well as the production of tapers**

For efficient, fitting-free installation of pipes in sanitary, heating, gas, refrigeration and air-conditioning systems

Suitable for pipes made of:

**Copper and aluminium (soft):**

Ø 35-108 mm, 1.3/8-4.1/8", max. wall thickness 2.5 mm

### Application Benefits

- Affordable alternative when laying larger pipe dimensions with a considerable saving of soldering materials
- Expand without changing tools with the 6 size step expander
- Full bearing of the expander head segments allows heavy loads
- Optimum adjustment of the socket size and capillary gap with the positive fine adjustment
- Optimised force transmission with the trapezoidal screw thread with self-lubricating bronze socket
- Compulsory guidance guarantees a perfect centred position and uniform capillary gap with 6 rivets and guiding ridge



Fig. similar special ratchet (No. 27181)

Sets include: step expander with handle, without special ratchet

Model	Weight	PU	No.
Step expander A4 35-42-54-67-80-104 mm	3.900 kg	1	11089
Step expander A3 35-42-54-64-76-108 mm	3.900 kg	1	11087
Step expander A2 42-54-64-76.1-88.9-108 mm	4.200 kg	1	11086
Step expander A5 1.1/4-4"	3.800 kg	1	11093
Step expander A1 1.3/8-1.5/8-2.1/8-2.5/8-3.1/8-4.1/8"	4.200 kg	1	11078



## Hydraulic expander system H 600

For expanding, reducing and calibrating normal and thick walled pipes in batch production as well as the production of tapers

Suitable for normal and thick-walled tubes made of  
**Copper and aluminum:**  
 Ø8–110 mm, 5/16–4.1/4", max. wall thickness 3.0 mm  
**Precision and stainless steel:**  
 Ø8–110 mm, 5/16–4.1/4", max. wall thickness 3.0 mm

### Application Benefits

- Individual modular design
- Industrial quality expansions
- Proper and efficient handling of material

### Technical Data

Working area pressure	80–600 bar
Voltage	400 V
Working area	Ø 5/16–4.1/4" (8–110 mm)
Power plug type	Plug type F (CEE 7/4)
Rated current	2.1 A
Rated recording power	1.2 kW



#### On-off switch with control light

Allows set-up and auto-mode

#### Individual modular design

Connections for safety foot pedal, control wires for the expander pistol H1 and / or H2 and quick coupling for hydraulic hose

#### Fine adjustment of the tube socket size

Industrial quality expansions



Continuous, accurate and adjustable operating power with set-up and auto-mode

Allows proper, efficient handling of material

Powerful 400 V / 1200 W drive

Quick expansion of large, thick-walled pipes

Suitable for all types of expander heads

Multi-functional

**Set (No. 13100) includes:** Electro-hydraulic expander system H 600 complete with hydraulic unit H 600 (No. 13002), expander pistol H1 (No. 12001), control cable, hydraulic hose 2.5 m with circuit points, adjusting tool, tool rack (No. 13023), safety foot pedal and hydraulic oil 1 l (No. 58185), without expander heads

**Set (No. 13002) includes:** Electro-hydraulic unit H 600 with safety foot pedal, adjusting tool, tool rack (No. 13023) and hydraulic oil 1 l (No. 58185), without expander heads

Model	Weight	PU	No.
Hydraulic unit H 600	33.100 kg	1	13002
Hydraulic unit H 601 without expander heads	36.000 kg	1	13100
Safety foot pedal with 3 m cable	0.520 kg	1	12013

### Electro-hydraulic expander pistol H1

Electro-hydraulic expander gun for expanding pipes with  $\varnothing 8-67$  mm (5/16-2.1/2")

**Expander heads standard:**

$\varnothing 8-42$  mm, 5/16-1.3/4", max. wall thickness 1.6 mm

**Expander heads type S:**

$\varnothing 22-67$  mm, 1-2.1/2", max. wall thickness 2.5 mm

**Application Benefits**

- Compatible with H 600 hydraulics
- Ideal for series production
- Robust construction for long service life



Adaptor (No. 12097)



Adjusting tool (No. 12018)



Adaptor (No. 11007)

Expander pistol H1 (No. 12001)

Set includes: 2.5 m control cable (No. F88928), hydraulic hose (No. 12023), adjusting tool (No. 12017), hydraulic oil 1 l (No. 58185)

Model	Weight	PU	No.
Electro-hydraulic expander pistol H1	2.900 kg	1	12001

### Expander adaptor type S

To increase the application area of the ROCAM / ROLOCK expander power torque, ROMAX expander compact standard and expander pistol H1

To extend the application range of the ROCAM, ROLOCK and H1 Expander.

**Application Benefits**

- Extends the application range of the ROCAM, ROLOCK and H1 expander up to  $\varnothing 67$  mm (2.1/2") in combination with the type S expander heads

**Technical Data**

Flange nut  $\varnothing 67$  mm (2.1/2")

Model	Weight	PU	No.
Adaptor type S without expander heads, 22-67 mm (1-2.1/2")	0.630 kg	1	11007
Adaptor type S for H2, 70-110 mm	1.100 kg	1	12097

Allows the use of the expander heads type S with copper pipe (soft) up to  $\varnothing 67$  mm and/or 2.1/2"!













Expander adaptor (No. 11007) for ROCAM expander power torque or expander pistol H1



Expander adaptor (No. 12097) for expander pistol H2

4

### Expander head compatibility

	Expander head ROLOCK	Expander head standard	Expander head type S	Riveted expander head	Expander head PE-X	Expander head H2, type 2/3	Step expander head
ROLOCK expander power torque 	●	●		●	○	○	○
ROCAM expander power torque 	○	●		●	● No. 12005	○	○
Expander A0 	○	○	●	○	○	○	○
Expander A1 	○	○	○	○	○	○	●
Expander pistol H1 	○	●		●	○	○	○
Expander pistol H2 Fig. similar 	○	○		○	○	●	○

● Expander head can be used without adaptor ○ Expander head can not be used Fig.: Can be used with the appropriate adaptor (pictured)

## ROLOCK COMBI KIT expander / extractor

Practical, compact and cost-saving set combinations with ROLOCK expander power torque and tee-extractors. For all common pipe dimensions  $\varnothing$  12-28 mm (1/2-1.1/8")

Suitable for pipes made of:

**Copper, aluminium and steel (soft):**

$\varnothing$  12-28 mm, 1/2-1.1/8"



### Made in Germany

The know-how from the pioneer of expanding technology and the leading manufacturer of expanding tools for over 50 years!

### Application Benefits

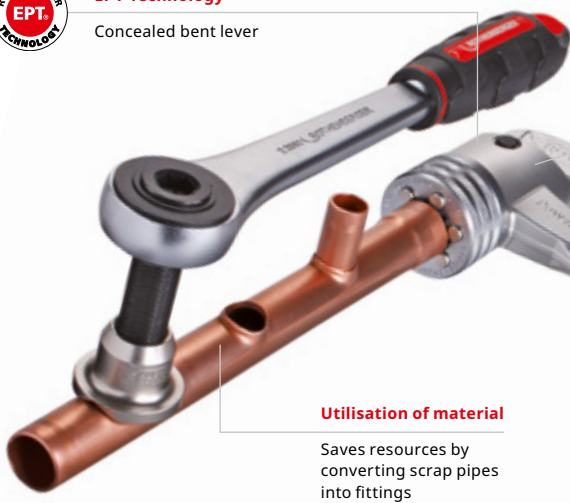
- Increases safety by reducing the number of connections
- Suitable for making branches even in confined spaces through the compact design
- Toolless fine adjustment of the capillary gap
- Reduces effort required and increases work space
- Up to 67% reduction of soldering materials and soldered joints
- Accurate drilling
- Saves resources by converting scrap pipes into fittings
- Reliable pipe connections to DVGW standards

4



### EPT-Technology

Concealed bent lever



### Utilisation of material

Saves resources by converting scrap pipes into fittings

### Largest possible expansion size and toolless adjustable capillary gap



### Professional extractions

Up to 67% reduction of soldering materials and soldered joints

### Long handles

Reduces effort required and increases work space

### UNIDRILL Automatic 28 / 42

Accurate drilling



No. 21583 / No. 21575

### Scale and cam depth adjustment



### Extractor cam pincer

Limits insertion depth for  $\varnothing$  13-38 mm (1/2-1.1/2")

No. 22080



Fig. similar

Sets include: ROLOCK expander power torque (No. 12400), ROLOCK expander heads, tee-extractor, special ratchet (No. 27180), adaptor (No. 1500002894), UNIDRILL Automatic 28 (No. 21583), extractor cam pincer (No. 22080), carrying case

Model	Weight	PU	No.
1/2-3/4-1"	2.500 kg	1	12605
1/2-5/8-7/8-1.1/8"	2.800 kg	1	12604
12-14-16-18 mm	2.600 kg	1	12602
12-15-18-22 mm	4.400 kg	1	12601

### Extractor set

For efficient production of T-branches (extractions) for fitting-free pipe installations, Ø 10–42 mm (3/8–2.1/8")

Suitable for pipes made of:

**Copper (soft, semi-hard, hard):**

Ø 10–42 mm, 3/8–2.1/8", max. wall thickness 2.5 mm

**Aluminium:**

Ø 10–42 mm, 3/8–2.1/8", max. wall thickness 2.5 mm

**Precision steel:**

Ø 10–42 mm, 3/8–2.1/8", max. wall thickness 2.5 mm



### Application Benefits

- Eliminates the cost for T-pcs., purchase and storage of fittings
- Extractions even on installed pipes possible
- Accurate drilling
- Optimal positioning with the cam pincher depth adjustment

**Made in Germany**  
The know-how from the pioneer of expanding technology and the leading manufacturer of expanding tools for over 50 years!



**Limits the insertion depth**  
Optimal positioning

**No pipe removal**  
Extractions even on installed pipes possible

**Optimum capillary gap**  
Professional extractions

**UNIDRILL Automatic 28 / 42**  
Accurate drilling

**Scale and cam depth adjustment**

**Extractor cam pincher**  
Limits insertion depth for Ø 13–38 mm (1/2–1.1/2")

No. 22080

No. 21583 / No. 21575

Sets include: tee-extractor according to chart, special ratchet (No. 27180), adaptor (No. 1500002894), cam pincher (No. 22080) and special conical drill, UNIDRILL Automatic 42 (No. 21575), carrying case



Fig. similar

Model	Weight	PU	No.
1/2-3/4-1"	3.300 kg	1	22135
1/2-5/8-3/4-7/8"	3.480 kg	1	22121
1/2-5/8-7/8-1.1/8"	3.700 kg	1	22124
10-12-14-16-18-22 mm	3.780 kg	1	22111
12-14-16-18-22 mm	3.600 kg	1	22109
12-15-18-22 mm	3.400 kg	1	22100
12-15-18-22-28 mm	3.900 kg	1	22103
12-15-18-22-28-35-42 mm	5.500 kg	1	22126
15-22-28 mm	3.600 kg	1	22127

**Extractor**

**Suitable for producing extractions on copper pipes with Ø 10–54 mm (3/8–2.1/8")**

**Application Benefits**

- Uniform and material friendly extractions without scratches and burrs
- Burr-free operation due to specially polished extractor hooks
- Easy insertion into the drilled hole with the special hook design
- Secure support and positioning for precise 90° branches

**Double V-block**

Accurate and firm positioning for exact 90° branches

**Specially polished, forged and tempered extractor hooks**

Burr-free operation

**Special hook design**

Easy insertion into the drilled hole

Ratchet adaptor (No. F80053 and F80054) with No. 22050 / 22054 included in scope of delivery (square, 3/4")



Model	Weight	PU	No.
Extractor 10 mm	0.130 kg	1	22010
Extractor 12 mm	0.150 kg	1	22012
Extractor 14 mm	0.160 kg	1	22014
Extractor 15 mm	0.160 kg	1	22015
Extractor 16 mm (5/8")	0.220 kg	1	22016
Extractor 18 mm	0.220 kg	1	22018
Extractor 22 mm	0.350 kg	1	22022
Extractor 28 mm	0.470 kg	1	22028
Extractor 35 mm (1.3/8")	0.700 kg	1	22035
Extractor 38 mm (1.1/2")	0.700 kg	1	22038
Extractor 42 mm	0.890 kg	1	22042

Model	Weight	PU	No.
Extractor 54 mm (2.1/8")	1.380 kg	1	22054
Extractor 3/8"	0.110 kg	1	22060
Extractor 1/2"	0.140 kg	1	22061
Extractor 3/4"	0.220 kg	1	22062
Extractor 7/8"	0.350 kg	1	22063
Extractor 1"	0.470 kg	1	22064
Extractor 1.1/8"	0.480 kg	1	22065
Extractor 1.1/4"	0.700 kg	1	22066
Extractor 1.5/8"	0.900 kg	1	22068
Extractor 2"	1.380 kg	1	22050

**Spare extractor hook**

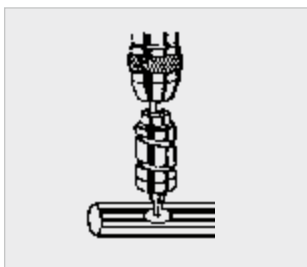
**Hooks, specially polished, tempered from Ø 10–54 mm (3/8–2.1/8")**

Model	Weight	PU	No.
Spare extractor hook 14 mm	0.090 kg	1	22214
Spare extractor hook 42 mm	0.320 kg	1	22242
Spare extractor hook 54 mm (2.1/8")	0.560 kg	1	22254
Spare extractor hook 3/4"	0.140 kg	1	22263
Spare extractor hook 3/8"	0.060 kg	1	22260
Spare extractor hook 7/8"	0.200 kg	1	22264

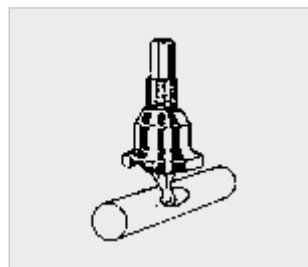


Model	Weight	PU	No.
Spare extractor hook 1"	0.210 kg	1	22265
Spare extractor hook 1.1/8"	0.220 kg	1	22266
Spare extractor hook 1.1/4"	0.270 kg	1	22267
Spare extractor hook 1.5/8"	0.320 kg	1	22270
Spare extractor hook 2"	0.520 kg	1	22246

Precise drilling of the pipe without a centre punch—drill stop prevents perforation of the pipe



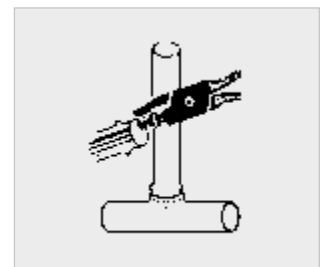
Insert extractor hook into the drilled hole and screw the bell firmly against the drill hole



Using the ratchet, turn the extractor to the left, while paying attention that the V-block is seated securely



After extraction, set correct insertion depth (dependant on pipe Ø) with cam pincer



Simply calibrate the tee Ø on the UNIDRILL Automatic and the drilled hole Ø will automatically correspond to the extractor hook required.

## Extractor ratchet

In combination with the neckers for an even and material-friendly necking of pipes and suitable for right- and left-handers.

### Application Benefits

- Made of chrome vanadium steel
- Fine toothed, reversible right/left



Model	Weight	PU	No.
Extractor ratchet 10–42 mm (3/8–1.3/4")	0.435 kg	1	27180
Extractor ratchet 50–54 mm, (2–2.1/8")	1.140 kg	1	27181

## Extractor cam pincer

For marking and limiting the insertion depth on the tube for  $\varnothing$  13–38 mm (1/2–1.1/2")

### Application Benefits

- Marking point ensures exact insertion depth and prevents poking through
- Cam depth adjustment wheel with scale



Model	Weight	PU	No.
Extractor cam pincer 13–38 mm (1/2–1.1/2")	0.150 kg	1	22080

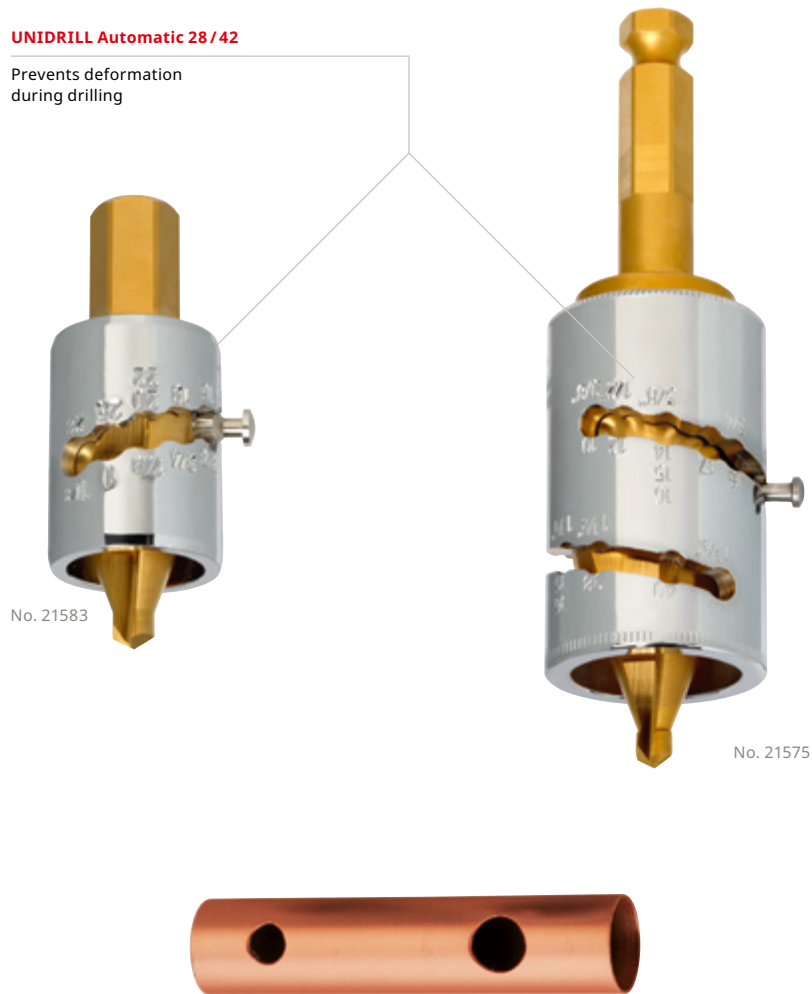
### UNIDRILL Automatic 28 / 42

#### HSS special conical drill

#### Application Benefits

- Fast, burr-free drilling
- Precise location without need for centre punch special drill tip
- Calibrated drill  $\varnothing$  automatically corresponds to the correct extractor hook and branch size
- Drill stop prevents damage to pipe walls

4



Model	Weight	PU	No.
UNIDRILL Automatic 28, 10–28 mm (3/8–1.1/8")	0.110 kg	1	21583
UNIDRILL Automatic 42, 10–42 mm (3/8–1.5/8")	0.430 kg	1	21575



### Precision double flaring press DB 10

For standard precision expands according to DIN 74234  
 Ø 4.75–10 mm, wall thickness 0.7–1.0 mm

On copper, aluminium and steel pipes, seamless pipes and double-walled pipes, for example Bundy pipe and KUNIFER brake pipes.

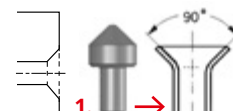
#### Application Benefits

- Ideal for endless pipes
- For several flaring profiles, wall thickness 0.7–1.0 mm
- Universal use with the pluggable pressure cone
- Accurate and reproducible results
- Clamping block for several pipe diameters
- Clamping block for several pipe diameters
- Reliable hold with the 25 mm pipe clamping length
- Suitable for clamping in a vice

### Formation of the various flares made possible with the appropriate flaring attachments

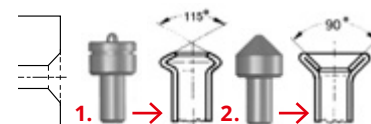
#### E- contour, simple flare

- Standard flaring contour



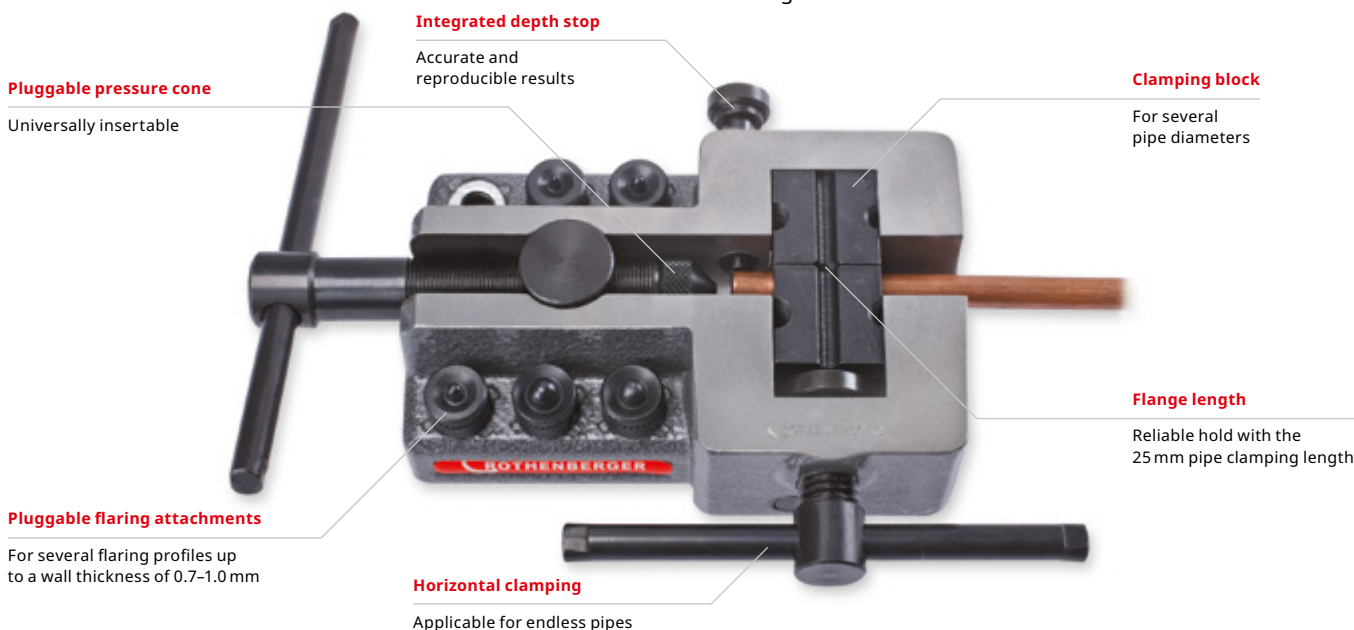
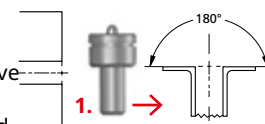
#### D-contour, double flare

- Extension of brake and/or hydraulic lines
- Connection by means of coupling rings, sealed by means of flaring surface



#### 180° flares

- Mounting using coupling ring, for example hydraulic transmission valve and/or distributor block
- Seal between drill-hole and flaring surface



Set (No. 26013) includes: basic tool with pressure cone (No. 26010), flaring attachments, 1 set of clamping blocks (No. 26011)

Model	Weight	PU	No.
DB 10 4,75–5–6–8–9–10 mm	2.640 kg	1	26013
Flanging inserts 4.75–5 mm	0.200 kg	1	26001
Flanging inserts 6 mm	0.200 kg	1	26002
Flanging inserts 8 mm	0.200 kg	1	26003
Flanging inserts 9 mm	0.200 kg	1	26004
Flanging inserts 10 mm	0.200 kg	1	26005

Model	Weight	PU	No.
Cone pressure piece	0.020 kg	1	26010
Clamping block 4.75–5–6–8–9–10 mm, 2 pcs.	0.190 kg	1	26011
Flaring spindle	0.300 kg	1	26016
Clamping spindle	0.090 kg	1	26015
Distance bolt	0.030 kg	1	26017

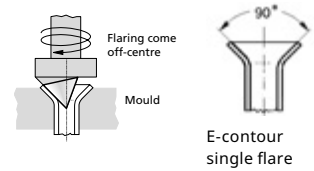
## ROFLARE REVOLVER

### Revolver reeling flaring tool

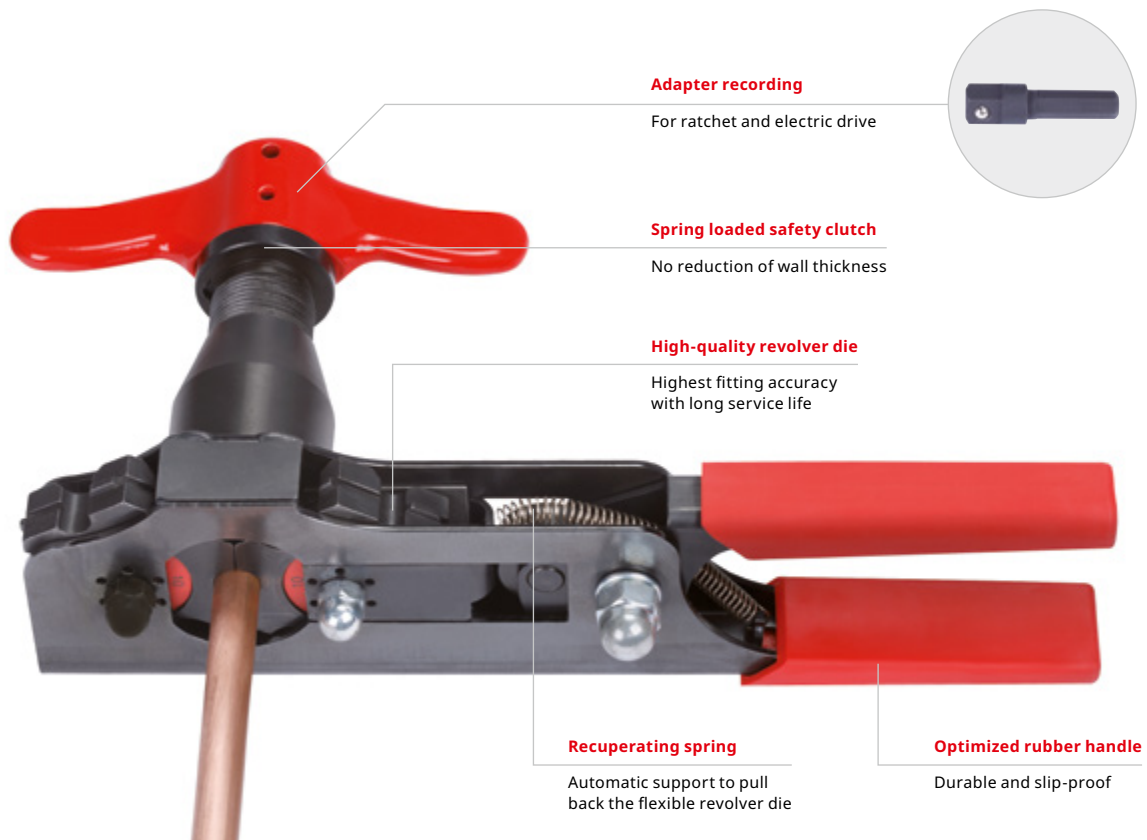
For the reliable and fast production of standard single 45° flares in accordance with EN 14276-2 and JIS B8607:2008 on copper soft pipes Ø 6–18 mm and 1/4–3/4"

#### Application Benefits

- Guaranteed norm flares
- Produces leak free joints
- One-handed quick clamping system
- Automatic depth stop: perfect positioning of the pipe to the flaring cone



4

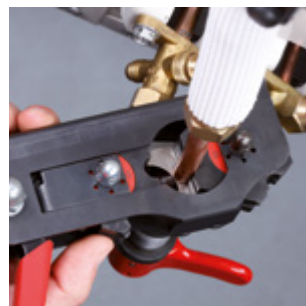


Set (No. 100000230) includes: ROFLARE REVOLVER metric incl. ratchet adaptor, dies Ø 6, 8, 10, 12, 16 and 18 mm, pipe cutter ROTRAC 28 PLUS chrome limited edition (No. 1000000046), ROCASE 4212 (No. 1300003334)

Set (No. 100000231) includes: ROFLARE REVOLVER imperial incl. ratchet adaptor, dies Ø 1/4, 5/16, 3/8, 1/2, 5/8 and 3/4", pipe cutter ROTRAC 28 PLUS chrome limited edition (No. 1000000046), ROCASE 4212 (No. 1300003334)

Model	Weight	PU	No.
Metric, 6–8–10–12–16–18 mm	1.300 kg	1	100000222
Imperial, 1/4–5/16–3/8–1/2–5/8–3/4"	1.710 kg	1	100000223
Set metric with ROTRAC 28 PLUS chrome, limited edition	1.300 kg	1	100000230
Set imperial with ROTRAC 28 PLUS chrome, limited edition	1.900 kg	1	100000231

Compact design enables use in confined spaces



Automatic depth stop: perfect positioning of the pipe to the flare cone

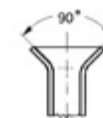
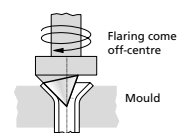


### Reeling flaring tool

For producing precise 45° single flares on copper pipes  
 Ø 6–18 mm (1/8–3/4")

#### Application Benefits

- Controlled expanding and shaping of the pipe without tearing
- No reduction in wall thickness
- No slipping of the pipe
- Sturdy and long lasting



E-contour single flare



No. 222401, No. 222402,  
 No. 222403

#### Square connection

For manual operation, for example cordless screwdriver

#### Spring-loaded slide coupling

No reduction in wall thickness

#### Flare cone rotates off-centre in needle bearings

Controlled expanding shaping of the pipe end without tearin

#### Made from forged steel

Robust and long-lasting

#### Self-centring die

Highest flare precision

Adaptor for cordless screwdriver

Die available in metric and imperial sizes

Pipe will not slip



Fig. similar

Model	Weight	PU	No.
Dies metric, 6–8–10–12–14–15–16–18 mm	0.400 kg	1	222413
Dies imperial, 1/8–3/16–1/4–5/16–3/8–1/2–5/8–3/4"	0.400 kg	1	222412

Reeling flaring tool set includes: reeling flaring tool in plastic case with mould in metric and/or imperial format

Model	Weight	PU	No.
Set metric, 6–8–10–12–14–15–16–18 mm	2.080 kg	1	222403
Set imperial, 1/8–3/16–1/4–5/16–3/8–1/2–5/8–3/4"	2.030 kg	1	222402
Set metric and imperial, 6–8–10–12–14–15–16–18 mm 1/8–3/16–1/4–5/16–3/8–1/2–5/8–3/4"	2.650 kg	1	222401

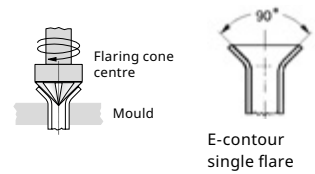
Flaring

**Universal flaring tool**

For producing precise 45° single flares on copper pipes  
 Ø 4–16 mm (3/16–5/8")

**Application Benefits**

- Universal application and highest flare precision through selfcentring pipe clamp for all diameters
- Controlled flaring without tearing, forming perfect surfaces
- Hardened flare cone with special geometry



Universal flaring tool set (No. 222601) includes: universal flaring tool for pipe diameters 4–16 mm, 3/16–5/8", in plastic case

Model	Weight	PU	No.
Universal flaring tool 4–16 mm (3/16–5/8")	0.900 kg	1	222601

**Flaring and bending set**

Universal application in industry and small trade by sanitary and heating installations, refrigeration and air-conditioning technology, auto and hydraulic technology

**Application Benefits**

- All in one case–flaring and bending tool always at the ready
- All sizes from 4.75 mm to 10 mm can be treated
- Additional accessories such as an internal and external deburrer are included in the case



Fig. similar

Flaring and bending set (No. 26020) includes: MINICUT I, Ø 3–16 mm (No. 70401), internal and external deburrer, Ø 4–36 mm (No. 11006), double flare press DB 10 (No. 26013), TUBE BENDER set, Ø 4.75–10 mm (No. 24112)

Model	Weight	PU	No.
Flaring and bending set 4,75–5–6–8–9–10 mm	5.500 kg	1	26020
Flange device and 735 CR	1.780 kg	1	490050016

## ROTORQUE AIRCON / REFRIGERATION

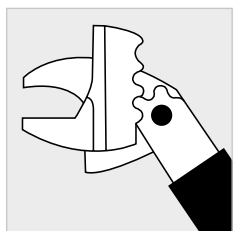
### Step-less torque wrench

Self-locking rack and pinion drive enables quick and reliable fastening of flare nuts sizes 15–32 mm in accordance with EN 378-2:2012-08

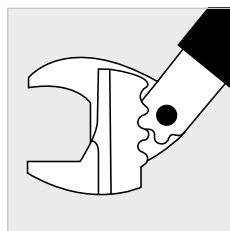
#### Application Benefits

- Always fits, covers all flare nut sizes from 15–32 mm
- Won't slip thanks to the self-locking rack and pinion drive and ratchet function
- Simple and reliable: required torque in accordance with EN 378-2:2012-08 is embossed on the head for every size and can not be rubbed off
- Embossed torque data: easy tightening according to norm
- ROTORQUE REFRIGERATION is suitable for cylinder heads work

Closed head



Fully opened head



ROTORQUE sets include: torque wrench, head, carrying bag

Model	Weight	PU	No.
ROTORQUE REFRIGERATION	1.500 kg	1	1000000224
ROTORQUE AIRCON	1.400 kg	1	1000000225

### Torque wrench set

#### For proper tightening of flange connections

Set with adjustable torque wrench (10-70 Nm) and 6 spanner inserts sizes 17, 22, 24, 26, 27 and 29 mm for flange connections on 1/4", 3/8", 1/2" and 5/8" pipe lines according to DIN EN 378- 2:2012-08

#### Application Benefits

- For proper tightening of flare nuts
- Torque adjustable between 10 and 70 Nm
- 6 interchangeable spanner inserts with width 17, 22, 24, 26, 27 and 29 mm
- For flare connections with pipe diameter of 1/4", 3/8", 1/2" and 5/8" according to DIN EN 378-2: 2016
- All components in a carrying case

7 pcs. set (No. 175001) includes: spanner wrench sizes 17, 22, 24, 26, 27, 29 mm, torque wrench, carrying bag

Model	Weight	PU	No.
Torque wrench set 17-22-24-26-27-29 mm	3.500 kg	1	175001

#### Connection 9 × 12

Head can be exchanged between ROTORQUE AIRCON and ROTORQUE REFRIGERATION

All-In-One: one head fits all sizes!



The torque can be read of

Always tighten according to the standard



#### ROTORQUE AIRCON torque wrench

- 10–110 Nm
- ± 4 % accuracy
- 1 Nm adjustment steps

#### ROTORQUE REFRIGERATION torque wrench

- 10–70 Nm
- ± 3 % accuracy
- 1/2 Nm adjustment steps
- Suitable for cylinder heads' work



Fig. ROTORQUE AIRCON torque wrench



Fig. ROTORQUE REFRIGERATION torque wrench

Fix with torque urgently necessary!



Fig. similar

Pipe-Ø	Spanner width	Locking torque
1/4" / 6 mm	17 mm	14–18 mm
3/8" / 10 mm	22 mm	33–42 mm
1/2" / 12 mm	24 mm	50–62 mm
1/2" / 12 mm	26 mm	50–62 mm
5/8" / 15/16 mm	27 mm	63–77 mm
5/8" / 15/16 mm	29 mm	63–77 mm



## Pressing



<b>System overview</b>	<b>122-123</b>
Constant Force Technology	120
DURA LAZR TEC	121
Press machine compact	124-125
Press machines standard	126-129
Conex Bänninger® >B< MaxiPro® press system	130-132
Press rings	133
Press jaws compact	134-135
Press jaws standard	136-137
Press chains standard	138
Overview pressing tools	139-140
Overview system approvals	141-145

## Constant Force Technology

The CFT guarantees a constant axial pressing force over the entire service interval. A very important requirement for the production of sealed press connections.

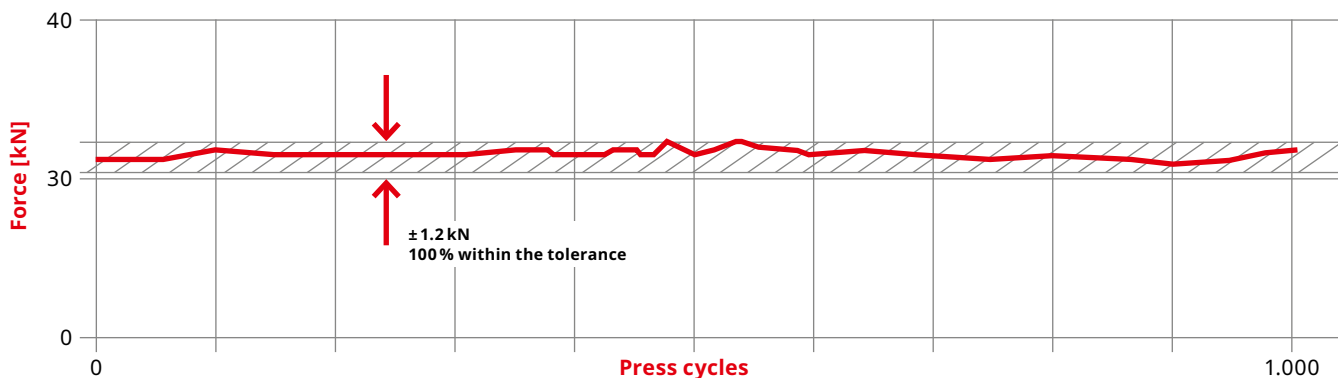


### CFT guarantees:

- ROMAX Compact III: 19 kN / 40,000 press cycles
- ROMAX Compact TT: 19 kN / 40,000 press cycles
- ROMAX 4000: 32 kN / 40,000 press cycles
- ROMAX 3000 AC: 32 kN / 20,000 press cycles
- ROMAX AC ECO: 32 kN / 10,000 press cycles

### Constant force due to CFT

Measurement under load—UPONOR NW 75



## No system commitment

Users are free to decide which fitting systems they want to press. They are also free to choose the manufacturer of the press machines and press tools. There is no legal provision, DIN standard or other provision—for example, a regulation established by means of a DVGW worksheet—which obligates the tradesmen to exclusively use the press tools or press jaws of just one fitting or piping system manufacturer.

The only decisive factor is whether the fitting system and pressing tool are suitable for one another – only in this case is the tightness guaranteed. The Pressnavigator app provides guidance by enabling users to find the suitable press tool for the fitting system, or the suitable fitting system for the press tool.



## Controlled press cycle

After reaching a predetermined pressing force the press cycle switches off automatically. The piston retracts after the necessary pressing force has been reached. This guarantees uniform and reliable pressings as leading system manufacturers require.

## Electronic control

The electronics of the ROMAX Compact III, ROMAX Compact TT, ROMAX 4000, ROMAX 3000 AC provide for a safe pressing cycle:

- Control of the battery charge status
- Safety start-inhibitor when the battery is too low
- LED display of the service interval and any error messages

## CAS – Cordless Alliance System

- cross-manufacturer battery alliance
- 100% compatibility of batteries and chargers with tools and machines of all alliance partners
- 18-volt battery technology from Metabo
- Strong brands for the professional user and high specialization

## AMPShare – Powered by Bosch

- cross-manufacturer battery alliance
- 100% compatibility of batteries and chargers with tools and machines of all alliance partners
- 18-volt battery technology from Bosch
- High availability and global distribution thanks to 100% compatibility with all Bosch Professional batteries since 2008—more than 80 million rechargeable batteries on the market



## DURA LAZR TEC

### The unique laser-hardening process

Long-lasting. Safe. Precise. Our DURA LAZR TEC press jaws set is a new industry standard. The unique ROTHENBERGER laser-hardening process, which is implemented in our own production, provides maximum stability and wear resistance. And, therefore, more safety and a longer service life!



### Partial laser-hardening for highly stressed surfaces

- Ideal accuracy of contour for highest precision during the complete live time
- 40% increase in hardness<sup>1</sup>

### Highest degree of hardness

- ROTHENBERGER press jaws are performing with the highest degree of hardness at high stressed areas
- Even in the case of high burr formation during compression, the wear is reduced to a minimum

**ROTHENBERGER press jaws before surface treatment**



5

**+ 40 %  
HARDNESS  
AT HIGHLY STRESSED  
AREAS<sup>1</sup>**

**+100%  
PRESS CYCLES  
WITH LASER  
HARDENING<sup>1</sup>**



### Double lifetime

Partial Laser Hardening ensures an appropriate Optimization in Usage. Heavily Loaded Areas of the Press Jaw will be specifically hardened. Non-loaded Areas remain ductile for a proper Force Load Compensation.

### Adjustment of the plate

Durability increased by approx. 45%<sup>1</sup>

Depth distribution of hardness was tested by the independent test laboratory of the State Materials Testing Institute Darmstadt (MPA).



1) In comparison to previous models

## Press jaws

## Press jaws compact

## Press jaws standard

Press jaws standard  
3-elemental

Working range metal	Ø 12–35 mm	Ø 12–54 mm	Ø 42–54 mm
Working range multilayer	Ø 12–40 mm	Ø 12–40 mm	Ø 50–63 mm
Snap on	○	○	○
DURA LAZR TEC	●	●	●
Long-term corrosion prot.	●	●	●
3-bolt synch. mechanism	●	●	●
Precision-manufactured contour	●	●	●
Suitable for all press machines with a constant axial thrust of	19–21 kN	32–34 kN	32–34 kN
<b>Page</b>	<b>134</b>	<b>136</b>	<b>137</b>

## Press rings, press jaws and press chains

## Press rings

Interchangeable press jaw  
compact

## Press chains standard



Working range metal	Ø 12–35 mm	○	Ø 42–54 mm
Working range multilayer	Ø 14–40 mm	Ø 12–32 mm	○
Snap on	●	○	●
DURA LAZR TEC	●	○	●
Long-term corrosion prot.	●	●	●
3-bolt synch. mechanism	○	●	○
Precision-manufactured contour	●	●	●
Suitable for all press machines with a constant axial thrust of	19–21 kN 32–34 kN	19–21 kN	32–34 kN
<b>Page</b>	<b>133</b>	<b>135</b>	<b>138</b>

**>B< MaxiProPress jaws and press rings****Press jaws compact  
>B< MaxiPro****Press jaws standard  
>B< MaxiPro****Press rings  
>B< MaxiPro**

Working range metal	1/4–1.1/8"	1/4–1.1/8"	1/4–1.1/8"
Working range multilayer	○	○	○
Snap on	○	○	●
DURA LAZR TEC	●	●	●
Long-term corrosion prot.	●	●	●
3-bolt synch. mechanism	●	●	○
Precision-manufactured contour	●	●	●
Compatible with Conex Bänninger® >B< MaxiPro® press system	●	●	●
Suitable for all press machines with a constant axial thrust of	19–21 kN	32–34 kN	19–21 kN 32–34 kN
<b>Page</b>	<b>132</b>	<b>132</b>	<b>133</b>

**Press machines****ROMAX COMPACT III****ROMAX 4000****ROMAX 3000 AC****ROMAX AC ECO**

Constant Force Technology (CFT)	●	●	●	●
Controlled press cycle	●	●	●	○
Piston force / hub	19 kN / 30 mm	32 kN / 40 mm	32 kN / 40 mm	32 kN / 40 mm
Service intervall	40,000 pressings	40,000 pressings	20,000 pressings	10,000 pressings
LED	●	●	●	○
Pressing cycle time	3 s	5 s	5 s	7 s
Dimensions	336 × 143 × 76 mm	445 × 125 × 75 mm	460 × 120 × 90 mm	415 × 180 × 80 mm
Weight	2.500 kg	3.600 kg	3.800 kg	4.500 kg
Cordless	●	●	○	○
Connectivity	●	○	○	○
<b>Page</b>	<b>124</b>	<b>126</b>	<b>128</b>	<b>129</b>

## Pressing

### Press machine compact

## ROMAX Compact III

**Smart Electro-Hydraulic Press Tool (battery-operated) for pressing of fittings up to "Durchmessersymbol" 35 mm (Metal) and / or "Durchmessersymbol" 40 mm (Plastic / Multilayer) with 19 kN**

The ROMAX Compact III is 3 seconds fast, 2.5 kg light and 19 kN strong. Through the perfect handling, the machine is particularly suitable for domestic installations, high volume pressings or service installations.

### Application Benefits

- "Connected": Real-Time Data Gathering of Pressing Data and Creation of Job Reports via ROTHENBERGER App
- Fast: thanks to turbo pressure a pressing takes only 3 seconds
- Strong: presses metal fittings up to  $\varnothing$  35 mm and multilayer up to  $\varnothing$  40 mm
- Handy: perfectly balanced—the centre of gravity is where the user holds the tool
- Small and lightweight: with 34 cm in length, the ROMAX Compact TT weighs just 2.5 kg



### Technical Data

Dimension	336 × 143 × 76 mm (with 2.0Ah battery)
Piston force / hub	19 kN / 30 mm
Nominal size	$\varnothing$ 12–40 mm plastic / multilayer $\varnothing$ 12–35 mm metal
Service intervall	40,000 pressings / 2 years
Press jaw fixture	270° rotation
Power supply	Battery
Operation temperature	-10 °C up to 60 °C
Pressings (with SV18 stainless steel)	up to 130 times (with 2.0Ah battery)

5

#### Push-2-Lock-Knob

New Jaw Locking System (spring-loaded knob) allows convenient Attaching/Detaching of Press Jaws

#### Balanced Design

Optimized in weight and size for better machine handling in daily use

#### Bluetooth® inside

Connects the machine with ROTHENBERGER App

#### Multiple battery systems

Suitable for AMPShare or CAS battery systems

#### R-System Label

Jaw matching indicator reduces misuse risk of attaching incompatible jaws

#### Black Colored Parts

New coloration of Jaw Fixture and Bracket give the Machine a High-End-Look



**Available in the manufacturer-independent battery systems AMPShare - Powered by Bosch or CAS - CORDLESS ALLIANCE SYSTEM**

Connected Tool: Gain access to your COMPACT III and read out relevant Tool & Press Data via Smartphone in Real-Time.



Optimized Design of ROMAX COMPACT III makes all press jobs possible – even in narrow spaces.



With just 2.5 kg of weight, overhead jobs will be effortless even over an extended period of time.

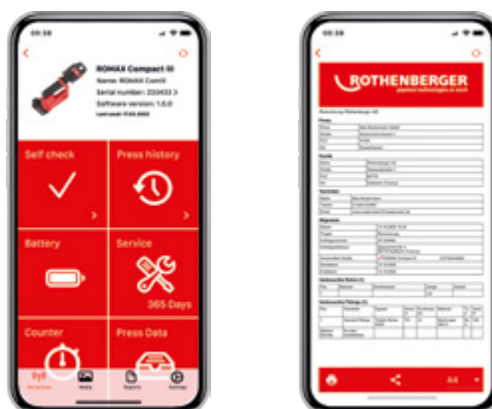


## Connected with the ROTHENBERGER App via Bluetooth®

The all-new ROMAX COMPACT III is ROTHENBERGER's first smart press machine with Bluetooth connectivity. Via the ROTHENBERGER app, tool and smartphone can be connected, providing the user real-time access to relevant machine and press data. Additionally, the app allows for easy and quick on-site creation of press protocols with smart logic, as well as reading the current maintenance status of the tool.

Compatibility iOS 8.1 or higher, Android 4.0 or higher

Size 73.3 MB



## ROMAX COMPACT III sets

Model	Press jaws Ø	Weight	PU	AMPShare-No.	CAS-No.
ROMAX COMPACT III bare tool		4.530 kg	1	1000004266	1000004265
ROMAX COMPACT III basic set 1, 1 × 2 Ah		5.480 kg	1	1000004267	1000004261
ROMAX COMPACT III basic set 1, 1 × 2 Ah, UK		4.900 kg	1	1000004271	1000004269
ROMAX COMPACT III basic set 1, 2 × 2 Ah		5.965 kg	1	1000004272	1000004263
ROMAX COMPACT III set M, 2 Ah	15–22–28 mm	9.250 kg	1	1000004274	1000004273
ROMAX COMPACT III set M, 2 Ah, UK	15–22–28 mm	9.260 kg	1	1000004333	1000004332
ROMAX COMPACT III set SV, 2 Ah	15–22–28 mm	9.250 kg	1	1000004276	1000004275
ROMAX COMPACT III set SV, 2 Ah, UK	15–22–28 mm	9.250 kg	1	1000004278	1000004277
ROMAX COMPACT III set TH, 2 Ah	16–20–26 mm	9.250 kg	1	1000004280	1000004279
ROMAX COMPACT III set TH, 2 Ah, UK	16–20–26 mm	9.250 kg	1	1000004424	1000004423
ROMAX COMPACT III set U, 2 Ah	16–20–25 mm	9.250 kg	1	1000004283	1000004281
ROMAX COMPACT III set U, 2 Ah, UK	16–20–25 mm	9.250 kg	1	1000004285	1000004284
ROMAX COMPACT III set RFZ, 2 Ah	16–20–25 mm	9.250 kg	1	1000004293	1000004292
ROMAX COMPACT III set >B< MaxiPro, 2 Ah	1/4–1.1/8"	17.500 kg	1	1000004287	1000004286
ROMAX COMPACT III set >B< MaxiPro, 2 Ah, UK	1/4–1.1/8"	17.500 kg	1	1000004289	1000004288

## Batteries and charger



No. 1000003858



No. 1000003859



No. 1000001654



No. 1000001652

Model	Weight	PU	AMPShare-No.
RO BP18/2, 2.0 Ah 18V	0.400 kg	1	1000003859
RO BP18/4, 4.0 Ah 18V	0.600 kg	1	1000003860
RO BP18/4, 4.0 Ah 18V, ProCORE	0.520 kg	1	1000003863
RO BP18/8, 8.0 Ah 18V, ProCORE	0.960 kg	1	1000003864
RO BC18 charger, 230V	0.550 kg	1	1000003858

Model	Weight	PU	CAS-No.
RO BP18/2, 2.0 Ah 18V	0.420 kg	1	1000001652
RO BP18/4, 4.0 Ah 18V	0.575 kg	1	1000001653
RO BP18/4, 4.0 Ah 18V, Li-HD	0.515 kg	1	1000002548
RO BP18/8, 8.0 Ah 18V, Li-HD	0.915 kg	1	1000002549
RO BC14/36 charger, 230V	0.580 kg	1	1000001654

## Pressing

### Press machines standard

#### ROMAX 4000

Electro-hydraulic radial battery-powered press machine for system depending pressing of fittings up to Ø 110 mm with 32–34 kN.

The ROMAX 4000 operates in just 5 seconds, weighs only 3.6 kg and uses a force of 32 kN. It can press from 12 mm to 110 mm depending on the system and is therefore the perfect all-rounder amongst the ROTHENBERGER press machines.

#### Application Benefits

- Low weight of 3.6 kg for fatigue-free work even in difficult situations
- Fast working by pressing in under 5 seconds
- Increased output through improved battery technology
- Increased service interval every 40,000 pressings / 2 years

Available in the manufacturer-independent battery systems AMPShare – Powered by Bosch or CAS – CORDLESS ALLIANCE SYSTEM



#### Technical Data

Dimension	467 × 125 × 80 mm (with 4.0 Ah battery) 445 × 125 × 75 mm (with 2.0 Ah battery)
Piston force / hub	32–34 kN / 40 mm
Nominal size	Ø 12–110 mm
Service intervall	40,000 pressings / 2 years
Press jaw fixture	270° rotation
Power supply	Battery
Operation temperature	-10 °C up to 60 °C
Pressings (with SV18 copper)	up to 240 times (with 4.0 Ah battery) up to 105 times (with 2.0 Ah battery)



#### Multiple battery systems

Suitable for AMPShare or CAS battery systems

## ROMAX 4000 sets



No. 1000003858



No. 1000001654



No. 1000003859



No. 1000001652



No. 1000003860



No. 1000001653

Ergonomic working with the ROMAX 4000



Productive working due to expanded service interval



Cordless Alliance System: One battery system for more than 140 tools



Model	Press jaws Ø	Weight	PU	AMPSHare-No.	CAS-No.
ROMAX 4000 bare tool		5.900 kg	1	1000004166	1000002683
ROMAX 4000 basic set 1 incl. 1 × 4.0 Ah battery		7.000 kg	1	1000004165	1000001840
ROMAX 4000 basic set 2 incl. 1 × 2.0 Ah battery and 1 × 4.0 Ah battery		8.000 kg	1	1000004167	1000001923
ROMAX 4000 press jaw set SV incl. 1 × 4.0 Ah battery	15–22–28 mm	15.000 kg	1	1000004173	1000001924
ROMAX 4000 press jaw set M incl. 1 × 4.0 Ah battery	15–22–28 mm	15.000 kg	1	1000004174	1000001927
ROMAX 4000 press jaw set M incl. 1 × 4.0 Ah battery, UK	15–22–28 mm	15.000 kg	1		1000001932
ROMAX 4000 press jaw set TH incl. 1 × 4.0 Ah battery	16–20–26 mm	15.000 kg	1	1000004169	1000001925
ROMAX 4000 press jaw set U incl. 1 × 4.0 Ah battery	16–20–25 mm	15.000 kg	1	1000004170	1000001926

## Batteries and charger

Model	Weight	PU	AMPSHare-No.	Model	Weight	PU	CAS-No.
RO BP18/2, 2.0 Ah 18 V	0.400 kg	1	1000003859	RO BP18/2, 2.0 Ah 18 V	0.420 kg	1	1000001652
RO BP18/4, 4.0 Ah 18 V	0.600 kg	1	1000003860	RO BP18/4, 4.0 Ah 18 V	0.575 kg	1	1000001653
RO BP18/4, 4.0 Ah 18 V, ProCORE	0.520 kg	1	1000003863	RO BP18/4, 4.0 Ah 18 V, Li-HD	0.515 kg	1	1000002548
RO BP18/8, 8.0 Ah 18 V, ProCORE	0.960 kg	1	1000003864	RO BP18/8, 8.0 Ah 18 V, Li-HD	0.915 kg	1	1000002549
RO BC18 charger, 230 V	0.550 kg	1	1000003858	RO BC14/36 charger, 230 V	0.580 kg	1	1000001654

## Pressing

### Press machines standard

#### ROMAX 3000 AC

**Electro-hydraulic press machine with mains operation for system dependent pressing of fittings up to Ø 110 mm with 32–34 kN.**

The ROMAX 3000 AC is fast, light, easy to handle and safe. It is therefore ideally suited for the batch production of fitting joints in field operation

#### Application Benefits

- Batch production possible due to mains operation (5 m cable length)
- A pressing cycle only lasts approx. 5 seconds
- Constant Force Technology (CFT) guarantees the necessary pressing force
- Extremely low weight as well as a balanced weight distribution
- Expanded operating temperature from -15 °C up to 60 °C
- The compact, wand-like design allows pressings even in confined spaces

#### Technical Data

Dimension	460 × 120 × 90 mm
Piston force / hub	32 kN / 40 mm
Nominal size	Ø 12–110 mm
Service intervall	20,000 pressings / 2 years
Press jaw fixture	270° rotation
Operation temperature	230 V / 50–60 Hz 110 V on request
Temperature	-15 °C up to 60 °C



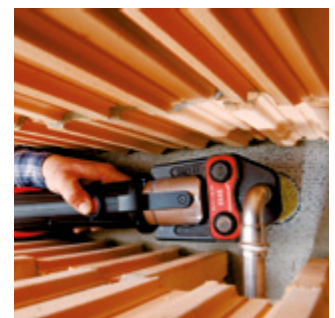
5



Batch production possible



Slim design



Basic set (No. 1000001001) includes: ROMAX 3000 AC, 230 V, ROCASE 6414 (No. 1000001959), without press jaws

Model	Weight	PU	No.
ROMAX 3000 AC basic set	6.970 kg	1	1000001001



## ROMAX AC ECO

Electro-hydraulic press machine with mains operation for system dependent pressing of fittings up to Ø 110 mm with 32–34 kN.

The ROMAX AC ECO is fast, light, easy to handle and safe. It is therefore ideally suited for the batch production of fitting joints in field operation

### Application Benefits

- Ergonomic thanks to the rubberized handle and balanced weight distribution
- Controlled press cycle
- Constant Force Technology (CFT) guarantees the necessary pressing force
- Safety lock guarantees no unintentional opening because a 180° rotation is necessary
- Emergency stop switch for immediate interruption of the feed
- 5 m cable for a large operations radius



### Technical Data

Dimension	415 × 180 × 80 mm
Piston force / hub	32 kN / 40 mm
Nominal size	Ø 12–110 mm
Service intervall	10,000 pressings / 2 years
Press jaw fixture	270° rotation
Operation temperature	230 V / 50–60 Hz 110 V on request

#### 270° rotatable jaw fixture

For easy use in confined spaces

#### Compatible jaw fixture

Suitable for common standard press jaws (32 kN)

#### Emergency stop switch

Immediate interruption of the feed

#### Safety lock

No unintentional opening because a 180° rotation is necessary

#### 5 m cable length

Large operations radius

#### Constant Force Technology (CFT)

For constant axial pressing force

#### Balanced weight distribution

Ergonomic use



Fig. ROMAX AC ECO press jaw set SV

Basic set (No. 15705) includes: ROMAX AC ECO, 230 V, ROCASE 6414 (No. 1000001959), without press jaws

Model	Press jaws Ø	Weight	PU	No.
ROMAX AC ECO press jaw set M	15–22–28 mm	13.400 kg	1	15750
ROMAX AC ECO press jaw set TH	16–20–26 mm	13.400 kg	1	15730
ROMAX AC ECO press jaw set SV	15–22–28 mm	13.400 kg	1	15740
ROMAX AC ECO press jaw set U	16–20–25 mm	13.400 kg	1	15760
ROCASE 6414 with inlay for ROMAX AC ECO		2.487 kg	1	1000001959



### Press jaw sets >B< MaxiPro

An innovative press system suitable for air-conditioning and refrigeration applications consisting of Conex Bänninger® >B< MaxiPro® fittings, suitable press jaws and press machines from ROTHENBERGER.

#### Tight connections up to 48 bar

- The O-ring is resistant against several oils including ester oil.
- The 3-point press, one on each side of the bead and one press compressing the O-ring, provides a permanent and secure joint.

#### The advantages

- Only 3 seconds per joint completion
- Saves approx. 3 minutes per connection
- Flame-free joint, no hot work permit needed
- No need for nitrogen purge

#### Made-to-last through laser hardening

The press jaws are partially laser-hardened. This makes them particularly durable in those places that take the most pressure. Laser hardening increases the jaws' durability considerably.



Press jaw for ROMAX Compact III No. 1000001751

Press jaw for ROMAX 4000, ROMAX 3000 AC and ROMAX AC ECO No. 1000001891

Press ring set >B< MaxiPro No. 1000003641

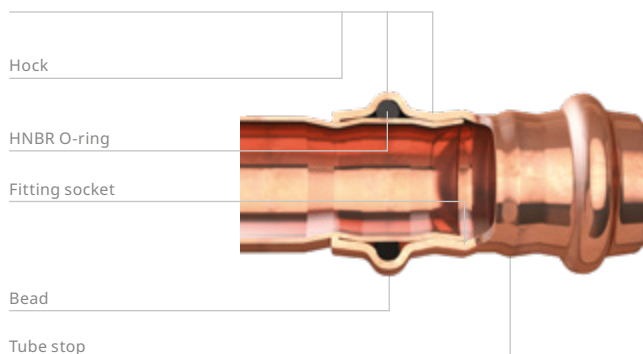


#### Technical Data

Application	Air-conditioning and refrigeration
Connections	Copper to copper
Dimensions	1/4", 3/8", 1/2", 5/8", 3/4", 7/8", 1", 1.1/8"
O-Ring	HNBR
Max. operating pressure	48 bar / 4,800 kPa / 700 psig
Leak tightness	He ≤ 7,5 × 10 <sup>-7</sup> Pa.m <sup>3</sup> /s at +20 °C, 10 bar
Vacuum	200 microns
Operating temperature	-40 °C up to 140 °C
UL listing continues operating temperature	121 °C
Compatible refrigerants	R32, R134a, R404A, R407C, R407F, R410A, R507, R1234ze, R1234yf, R718, R450A, R513A, R448A, R449A, R407A, R427A, R438A, R417A and R422D

#### 3-point press technology

Three press points: one on each side of the bead and one compressing the O-ring for a permanent and secure joint



Set (No. 1000004286) includes: ROMAX Compact III press machine, 1 × RO BP18/2, 2.0 Ah 18 V (No. 1000001652), RO BC14/36 charger, 230 V (No. 1000001654), 8 × press jaws (No. see below), TUBE CUTTER 35 (No. 70027), internal and external deburrer (No. 1500000237), UNIGRAT pencil deburrer (No. 21660), ROVLIES cleaning pads (No. 45268), depth gauge (No. 1000002400), 2 × ROCASE 4414 case system

Model	Press jaws Ø	Weight	PU	AMPShare-No.	CAS-No.
Press jaw set compact >B< MaxiPro	1/4–5/8"	6.000 kg	1		1000003580
Press jaw set compact >B< MaxiPro	1/4–1.1/8"	14.000 kg	1		1000001989
Press jaw set standard >B< MaxiPro	1/4–5/8"	6.000 kg	1		1000003581
Press jaw set standard >B< MaxiPro	1/4–1.1/8"	18.100 kg	1		1000002207
ROMAX Compact III press jaw set >B< MaxiPro incl. 1 × 2.0 Ah battery	1/4–1.1/8"	17.750 kg	1	1000004287	1000004286
ROMAX Compact III press jaw set >B< MaxiPro incl. 1 × 2.0 Ah battery, UK	1/4–1.1/8"	17.750 kg	1	1000004289	1000004288
ROMAX 4000 press jaw set >B< MaxiPro incl. 1 × 4.0 Ah battery	1/4–1.1/8"	24.300 kg	1	1000004175	1000002945
ROMAX 4000 press jaw set >B< MaxiPro incl. 1 × 4.0 Ah battery, UK	1/4–1.1/8"	24.300 kg	1		1000002946

## How to install the Conex Bänninger® >B< MaxiPro® system?

Conex Bänninger® >B< MaxiPro® benefits from a 3-point radial press—three press points, one on each side of the bead and one press compressing the O-ring. This provides a permanent and secure joint. As the connection is a mechanical joint, there is no need for nitrogen purge during the joining process.

1. Cut the tube to length.



2. Deburr and remove all external sharp edges.



3. Use a pencil deburrer on internal edges.



4. Clean the tube end with a circular movement, avoiding grooves that run parallel to the tube.



5. Check for defects.



6. Ensure the O-ring is seated.



7. Mark insertion depth using depth gauge and insert tube fully into the fitting.



8. Align jaws squarely on the fitting and complete the joint.



9. Mark the completed joint.



**Please note:** To ensure a safe and tight connection please follow the detailed Conex Bänninger® >B< MaxiPro® installation process. For more information, please visit the Conex Bänninger® website: [conexbanninger.com](http://conexbanninger.com)



### Accessories

	Weight	PU	No.
TUBE CUTTER 35, 6–35 mm (1/4–1.1/2”), DURAMAG	0.255 kg	1	70027
Internal and external deburrer, 6–35 mm (1/4–1.3/8”)	0.100 kg	1	1500000237
UNIGRAT with HSS deburring blade	0.030 kg	10	21660
ROVLIES, 10 pcs.	0.080 kg	1	45268
Conex Bänninger® >B< MaxiPro® depth gauge	0.050 kg	1	1000002400

### Batteries and charger

AMPSHare	Weight	PU	No.	CAS	Weight	PU	No.
RO BP18/2, 2.0 Ah 18V	0.400 kg	1	1000003859	RO BP18/2, 2.0 Ah 18V	0.420 kg	1	1000001652
RO BP18/4, 4.0 Ah 18V	0.600 kg	1	1000003860	RO BP18/4, 4.0 Ah 18V	0.575 kg	1	1000001653
RO BP18/4, 4.0 Ah 18V, ProCORE	0.520 kg	1	1000003863	RO BP18/4, 4.0 Ah 18V, Li-HD	0.515 kg	1	1000002548
RO BP18/8, 8.0 Ah 18V, ProCORE	0.960 kg	1	1000003864	RO BP18/8, 8.0 Ah 18V, Li-HD	0.915 kg	1	1000002549
RO BC18 charger, 230V	0.550 kg	1	1000003858	RO BC14/36 charger, 230V	0.580 kg	1	1000001654

The >B< MaxiPro® system is an innovative press system by Conex Bänninger®. >B< MaxiPro® and Conex Bänninger® are registered trademarks of Conex IPR Limited.

**Press jaws compact >B< MaxiPro****For ROMAX COMPACT III/ ROMAX COMPACT TT**

Suitable for use in pipe systems for refrigeration systems and heat pumps from -40 °C to +140 °C at a maximum operating pressure of 48 bar.

**Application Benefits**

- Flame free connection: No more working with open flame necessary
- Secure sealing: Reliable and durable connection through 3-point compression
- Fast, simple and cost-effective installation



Model	Press jaws Ø	Weight	PU	No.
Press jaw compact >B< MaxiPro	1/4"	1.265 kg	1	1000001749
Press jaw compact >B< MaxiPro	3/8"	1.250 kg	1	1000001750
Press jaw compact >B< MaxiPro	1/2"	1.180 kg	1	1000001751
Press jaw compact >B< MaxiPro	5/8"	1.180 kg	1	1000001752
Press jaw compact >B< MaxiPro	3/4"	1.190 kg	1	1000001753
Press jaw compact >B< MaxiPro	7/8"	1.290 kg	1	1000001754
Press jaw compact >B< MaxiPro	1"	1.930 kg	1	1000001755
Press jaw compact >B< MaxiPro	1.1/8"	1.275 kg	1	1000001756
Press jaw compact set >B< MaxiPro	1/4–5/8"	6.000 kg	1	1000003580
Press jaw compact set >B< MaxiPro	1/4–1.1/8"	14.000 kg	1	1000001989

**Press jaws standard >B< MaxiPro****For ROMAX 4000, ROMAX 3000 AC and ROMAX AC ECO**

Suitable for use in pipe systems for refrigeration systems and heat pumps from -40 °C to +140 °C at a maximum operating pressure of 48 bar.

**Application Benefits**

- Flame free connection: No more working with open flame necessary
- Secure sealing: Reliable and durable connection through 3-point compression
- Fast, simple and cost-effective installation



Model	Press jaws Ø	Weight	PU	No.
Press jaw standard >B< MaxiPro	1/4"	2.050 kg	1	1000001889
Press jaw standard >B< MaxiPro	3/8"	2.040 kg	1	1000001890
Press jaw standard >B< MaxiPro	1/2"	1.940 kg	1	1000001891
Press jaw standard >B< MaxiPro	5/8"	1.945 kg	1	1000001892
Press jaw standard >B< MaxiPro	3/4"	1.895 kg	1	1000001893
Press jaw standard >B< MaxiPro	7/8"	2.000 kg	1	1000001894
Press jaw standard >B< MaxiPro	1"	1.930 kg	1	1000001895
Press jaw standard >B< MaxiPro	1.1/8"	1.930 kg	1	1000001896
Press jaw standard set >B< MaxiPro	1/4–5/8"	6.000 kg	1	1000003581
Press jaw standard set >B< MaxiPro	1/4–1.1/8"	18.100 kg	1	1000002207

## Press rings >B< MaxiPro

For ROMAX COMPACT III / ROMAX COMPACT TT /  
ROMAX 4000 / ROMAX 3000 AC / ROMAX AC ECO

Suitable for use in pipe systems for refrigeration systems and heat pumps from -40 °C to +140 °C at a maximum operating pressure of 48 bar.



Actuator jaws are not included in the sets!

Model	Press ring Ø	Weight	PU	No.
Press ring >B< MaxiPro	1/4"	0.200 kg	1	1000003610
Press ring >B< MaxiPro	3/8"	0.200 kg	1	1000003611
Press ring >B< MaxiPro	1/2"	0.200 kg	1	1000003612
Press ring >B< MaxiPro	5/8"	0.250 kg	1	1000003613
Press ring >B< MaxiPro	3/4"	0.280 kg	1	1000003614
Press ring >B< MaxiPro	7/8"	0.310 kg	1	1000003615
Press ring >B< MaxiPro	1"	0.400 kg	1	1000003616
Press ring >B< MaxiPro	1.1/8"	0.380 kg	1	1000003617
Press ring set Small	1/4-5/8"	3.200 kg	1	1000003641
Press ring set Large	1/4-1.1/8"	3.600 kg	1	1000003703
Actuator jaw R Standard		2.360 kg	1	1000003589
Actuator jaw R Compact		1.370 kg	1	1000003590

## Press rings

For ROMAX COMPACT III / ROMAX COMPACT TT /  
ROMAX 4000 / ROMAX 3000 AC / ROMAX AC ECO

Press rings are suitable, among others, for machines with constant axial force of 19 kN or 32 kN and compatible jaw fixture.



Actuator jaws are not included in the sets!

Model	Press rings Ø	Weight	PU	No.	Model	Press rings Ø	Weight	PU	No.
Press ring SV	12 mm	0.220 kg	1	1000003872	Press ring TH	20 mm	0.540 kg	1	1000003931
Press ring SV	15 mm	0.290 kg	1	1000003874	Press ring TH	26 mm	0.470 kg	1	1000003933
Press ring SV	18 mm	0.280 kg	1	1000003876	Press ring TH	32 mm	0.640 kg	1	1000003934
Press ring SV	22 mm	0.300 kg	1	1000003877	Press ring U	18 mm	0.290 kg	1	1000003938
Press ring SV	28 mm	0.400 kg	1	1000003878	Press ring U	20 mm	0.280 kg	1	1000003939
Press ring SV	35 mm	0.430 kg	1	1000003879	Press ring U	25 mm	0.460 kg	1	1000003940
Press ring M <sup>1</sup>	12 mm	0.220 kg	1	1000003880	Press ring U	32 mm	0.580 kg	1	1000003941
Press ring M <sup>1</sup>	15 mm	0.290 kg	1	1000003881	Press ring set SV	15-18-22-28 mm	1.780 kg	1	1000003974
Press ring M <sup>1</sup>	18 mm	0.270 kg	1	1000003882	Press ring set M <sup>1</sup>	15-22-28-35 mm	1.930 kg	1	1000003973
Press ring M <sup>1</sup>	22 mm	0.310 kg	1	1000003883	Press ring set TH	16-20-26-32 mm	2.530 kg	1	1000003975
Press ring M <sup>1</sup>	28 mm	0.400 kg	1	1000003884	Press ring set U	16-20-25-32 mm	2.120 kg	1	1000003976
Press ring M <sup>1</sup>	35 mm	0.440 kg	1	1000003885	Actuator jaw R Standard		2.360 kg	1	1000003589
Press ring TH	18 mm	0.360 kg	1	1000003930	Actuator jaw R Compact		1.370 kg	1	1000003590

**Press jaws compact**

**For ROMAX Compact III/ROMAX COMPACT TT**



ROTHENBERGER press jaws with proven material and manufacturing quality for system dependent pressing of fittings up to Ø 40 mm (plastic/ multilayer) and / or up to Ø 35 mm (metal).

5

**DURA LAZR TEC**

100% more press cycles thanks to laser hardening<sup>1</sup>

**3-bolt synchronised mechanism**

Synchronised run of the jaw lever enables the jaw to be opened with just one finger

**Batch numbering and individual testing**

Secures the high-quality standard of material and press contour

Product identification, simple to read, clear system and nominal size classification



**Precision-manufactured contours**

For optimum and reliable pressings

**Made of forged, highly resilient special steel**

Suitable for all press machines with a constant axial thrust of 19–21 kN and compatible press jaw fixture

**Permanent bolt**

Without potential weak points / no thread n Considerable reduction of the breakage risk n Increased safety

**Long-term corrosion protection**

Optimum for heavy-duty field operation

**Optimum for heavy-duty field operation**

Adapted power flow and less wear and tear

Press jaws SV35 and M35 with optimized material and manufacturing quality



Model	Press jaws Ø	Weight	PU	No.
Press jaw compact SV	35 mm	2.225 kg	1	1000002266
Press jaw compact TH	40 mm	2.225 kg	1	015401X
Press jaw compact M	35 mm	2.225 kg	1	1000002267
Press jaw compact set SV	14–16–18–22 mm	4.900 kg	1	1000002801
Press jaw compact set SV	15–18–22–28 mm	5.960 kg	1	1000002800
Press jaw compact set TH	16–20–26–32 mm	6.425 kg	1	1000002803
Press jaw compact set M	15–18–22–28 mm	5.865 kg	1	1000002804

**Overview pressing tools starting on page 139**

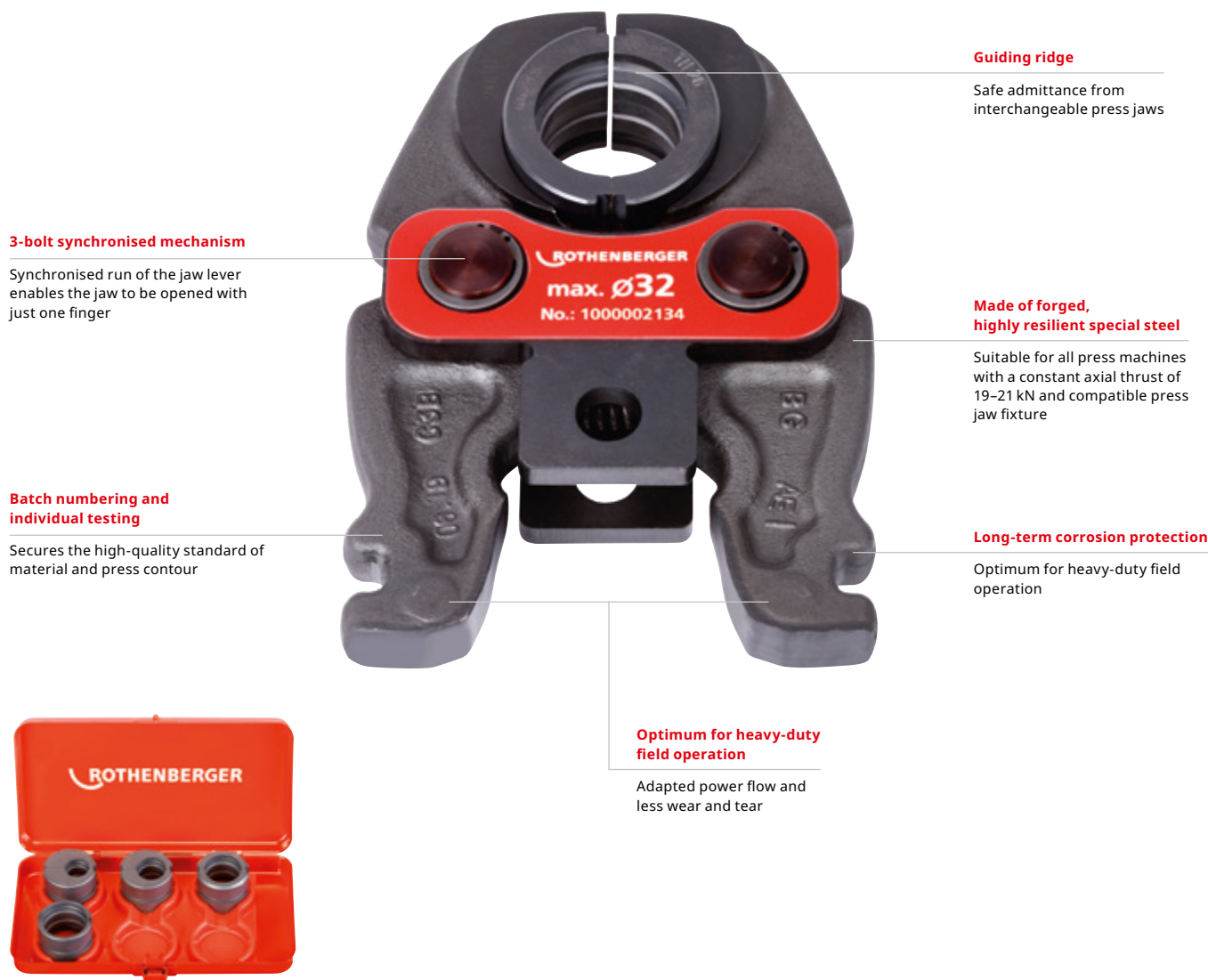
<sup>1</sup> In comparison to previous models

## Interchangeable press jaw compact

For ROMAX Compact III/ROMAX COMPACT TT

ROTHENBERGER interchangeable press jaw for system dependent pressing of plastic fittings Ø 12–32 mm.

Combine various interchangeable inserts with only one press jaw!



5

Fig. interchangeable inserts set

Model	Inserts Ø	Weight	PU	No.
Interchangeable inserts compact set RFz <sup>1</sup>	16–20–25–32 mm	1.110 kg	1	14849
Interchangeable inserts compact set U <sup>1</sup>	16–20–25–32 mm	1.350 kg	1	14869
Interchangeable inserts compact set TH <sup>1</sup>	16–20–26–32 mm	1.054 kg	1	14895
Interchangeable press jaw compact with set RFz	12–16–20 mm	1.111 kg	1	1000002135
Interchangeable press jaw compact with set CO	12–16–20 mm	1.111 kg	1	1000002136
Interchangeable press jaw compact, without inserts		1.320 kg	1	1000002134

Overview pressing tools starting on page 139

<sup>1</sup>) Can only be used with interchangeable press jaw No. 1000002134 (successor of No. 014880X)

**Press jaws standard**

**For ROMAX 4000, ROMAX 3000 AC and ROMAX AC ECO**



ROTHENBERGER press jaws with proven material and manufacturing quality, for system conforming pressing of fittings up to Ø 40 mm (plastic / multilayer) and / or up to Ø 54 mm (metal).

5

**DURA LAZR TEC**

100% more press cycles thanks to laser hardening<sup>1)</sup>

**3-bolt synchronised mechanism**

Synchronised run of the jaw lever enables the jaw to be opened with just one finger

**Batch numbering and individual testing**

Secures the high-quality standard of material and press contour

Product identification, simple to read, clear system and nominal size classification



**Precision-manufactured contours**

For optimum and reliable pressings

**Made of forged, highly resilient special steel**

Suitable for all press machines with a constant axial thrust of 32–34 kN and compatible press jaw fixture

**Permanent bolt**

Without potential weak points / no thread n Considerable reduction of the breakage risk n Increased safety

**Long-term corrosion protection**

Optimum for heavy-duty field operation

**Optimum for heavy-duty field operation**

Adapted power flow and less wear and tear



Fig. press jaw set SV

Model	Press jaws Ø	Weight	PU	No.
Press jaw standard set SV	15–22–28 mm	6.800 kg	1	1000002068
Press jaw standard set SV	15–18–22–28 mm	8.700 kg	1	015060X
Press jaw standard set SV	42–54 mm	10.540 kg	1	015080X
Press jaw standard set M	15–22–28 mm	6.700 kg	1	1000002067
Press jaw standard set M	15–18–22–28 mm	8.600 kg	1	015062X
Press jaw standard set TH	16–20–26 mm	8.700 kg	1	015063X
Press jaw standard set U	16–20–25 mm	7.300 kg	1	1000002069
Press jaw standard set G	16–20–26–32 mm	8.800 kg	1	015068X
Press jaw standard set BE	16–20–26 mm	8.730 kg	1	1000002065

**Overview pressing tools starting on page 139**

<sup>1)</sup> In comparison to previous models





### Press jaws standard 3-elemental

For ROMAX 4000, ROMAX 3000 AC and ROMAX AC ECO

ROTHENBERGER 3-elemental press jaws with proven material and manufacturing quality, for system dependent pressing of M42 / M54 fittings and TH50 / TH63 fittings.



**DURA LAZR TEC**

100% more press cycles thanks to laser hardening<sup>1)</sup>

**3-bolt synchronised mechanism**

Synchronised run of the jaw lever enables the jaw to be opened with just one finger

**3-elemental system**

Easy handling / assembling and optimized power distribution

**Precision-manufactured contours**

For optimum and reliable pressings

**Made of forged, highly resilient special steel**

Suitable for all press machines with a constant axial thrust of 32-34 kN and compatible press jaw fixture

**Permanent bolt**

Without potential weak points / no thread n Considerable reduction of the breakage risk n Increased safety

**Long-term corrosion protection**

Optimum for heavy-duty field operation

**Optimum for heavy-duty field operation**

Adapted power flow and less wear and tear

Wide jaw mouth for easy assembling of the jaw on the fitting



Model	Press jaws Ø	Weight	PU	No.
Press jaw standard M 3-elemental	42 mm	4.800 kg	1	1000001273
Press jaw standard M 3-elemental	54 mm	4.860 kg	1	1000001274
Press jaw standard TH 3-elemental	50 mm	4.800 kg	1	1000001810
Press jaw standard TH 3-elemental	63 mm	4.795 kg	1	1000001811
Press jaw standard set M 3-elemental	42-54 mm	12.000 kg	1	1000001502

1) In comparison to previous models

**Press chains standard**

**For ROMAX 4000, ROMAX 3000 AC and ROMAX AC ECO**

Suitable for press machines with a constant, axial pressing force of 32–34 kN and the appropriate compatible press jaw fixture. For the system conforming pressing of fittings from Ø 42 mm up to Ø 54 mm (metal).



**DURA LAZR TEC**

100% more press cycles thanks to laser hardening<sup>1</sup>

**Batch numbering and individual testing**

Secures the high-quality standard of material and press contour

**Long-term corrosion protection**

Optimum for heavy-duty field operation

Opening of the press chain up to 180° allows assembling even in confined spaces

Closing the press chain

Gripping the press chain with actuator jaw



Fig. press chain SV54

**Precision-manufactured contours**

For optimum and reliable pressings

**Clamping technology**

Self-clamping press chain

**3 segments**

For an optimum force distribution on the fitting and two flexible elements for an optimal material flow on the fitting

**Low weight**

Comfortable operation even over long periods of work

**Made of forged, highly resilient special steel**

Suitable for all press machines with a constant, axial force of 32–34 kN and compatible press jaw fixture

**3-bolt synchronised mechanism**

Synchronised run of the jaw lever enables the jaw to be opened with just one finger



Fig. Actuator jaw S1























Press chain sets include: Press chains according to the table, actuator jaw S1 (No.1000001126), ROCASE case system 4212 (No.1000001960)

Model	Press chains Ø	Weight	PU	No.
Press chain M	42 mm for actuator jaw ZBS1	1.300 kg	1	1000001391
Press chain M	54 mm for actuator jaw ZBS1	1.500 kg	1	1000001392
Press chain SV	42 mm for actuator jaw ZBS1	1.300 kg	1	1000001393
Press chain SV	54 mm for actuator jaw ZBS1	1.500 kg	1	1000001394
Press chain set SV with actuator jaw ZBS1	42–54 mm	7.300 kg	1	1000001501
Press chain set M with actuator jaw ZBS1	42–54 mm	7.600 kg	1	1000001500
Actuator jaw ZBS1	For press chains SV and M up to Ø 54 mm	2.100 kg	1	1000001126

Overview pressing tools starting on page 139

<sup>1</sup> In comparison to previous models

System	Nominal size	 Press jaws compact	 Interchangeable insert compact Use only in combination with interchangeable jaws (No. 1000002134)	 Press jaws standard	 Press chains standard Only to be used with actuator jaw S1 (No. 1000001126) for SV, M, Ø42-54 mm
<b>A</b>	<b>Metal / NE-Metal</b>				
	A1/2"			015222X	
	A3/4"			015223X	
	A1"			015224X	
	A11/4"			015225X	
	A11/2"			015226X	
	A2"			015227X	
<b>M</b>	M12	015151X		015101X	
	M15	015152X		015102X	
	M18	015153X		015103X	
	M22	015154X		015104X	
	M28	015155X		015105X	
	M35	1000002267		015106X	
	M42			1000001273	1000001391
	M54			1000001274	1000001392
	<b>V / SV</b>	V/SV12	015261X		015211X
	V/SV14	015269X		015219X	
	V/SV15	015262X		015212X	
	V/SV16	015260X		015220X	
	V/SV18	015263X		015213X	
	V/SV22	015264X		015214X	
	V/SV28	015265X		015215X	
	V/SV35	1000002266		015216X	
	V/SV42			015217X	1000001393
	V/SV54			015218X	1000001394
	<b>R(H)</b>	<b>PEX / Multilayer</b>			
	R12		14863	015339X	
	R14	015370X		015330X	
	R16	015371X	14865	015331X	
	R17	015378X		015333X	
	R18	015379X		015334X	
	R20	015374X	14868	015335X	
	R25	015380X		015338X	
	R26	015376X	14708	015336X	
	R32	015377X		015337X	
	<b>Rfz</b>	Rfz12		14822	1000000173
	Rfz16	015180X	14823	015161X	
	Rfz18		1000000124		
	Rfz20	015181X	14824	015162X	
	Rfz25	015182X	14825	015163X	
	Rfz26		1000000125		
	Rfz32	015183X	14826	015164X	
<b>TH</b>	TH14	015395X	14708	015321X	
	TH16	015385X	14843	015322X	
	TH18	015398X	14844	015323X	
	TH20	015389X	14845	015324X	
	TH25	015399X	14846	015325X	
	TH26	015391X	14847	015326X	
	TH32	015393X	14848	015327X	
	TH40	015401X		015328X	
	TH50			1000001810	
	TH63			1000001811	
	<b>THG</b>	THG32	1000000236		1000000235
<b>THT</b>	THT32	1000004620		015329X	

System	Nominal size	 Press jaws compact	 Interchangeable insert compact Use only in combination with interchangeable jaws (No. 1000002134)	 Press jaws standard	 Press chains standard Only to be used with actuator jaw ZB S1 (No. 1000001126) for SV, M, TH Ø40, 42, 50, 63 mm
<b>U</b>	<b>PEX / Multilayer</b>				
	U14	015351X	14832	015311X	
	U16	015352X	14833	015312X	
	U18	015353X	14834	015313X	
	U20	015354X	14835	015314X	
	U25	015355X	14836	015315X	
	U32	015357X	14838	015317X	
	U40	015358X		015318X	
	U50				
	U63				
	U75				
	U90				
U110					
<b>RC</b>	RC26	015277X	14837	015271X	
<b>VP</b>	VP14	015530X	14882	015230X	
	VP16	015531X	14883	015231X	
	VP20	015532X	14884	015232X	
	VP25	015533X	14885	015233X	
	VP32	015534X	14886	015234X	
	<b>BE</b>	BE16	015291X		015392X
	BE20	015292X		015394X	
	BE26	015293X		015396X	
	BE32	015294X		015397X	
	<b>CO</b>	CO12		14852	
	CO16		14853		
	CO20		14854		
	CO25		14855		
	<b>G</b>	G16	015362X		015302X
	G20	015364X		015304X	
	G26	015366X		015306X	
	G32	015367X		015307X	
	G40	015368X		015308X	
	<b>HA</b>	HA16	015580X		015280X
	HA20	015581X		015281X	
	HA26	015582X		015282X	
	HA32	015583X		015283X	
	HA40			015284X	

5

**Pressnavigator app**

Pressnavigator for easy verification of the compatibility of press tool and fitting system.

Which press tool is suitable for which fitting system?

The ROTHENBERGER Pressnavigator offers convenient assistance: with just a few clicks, the compatibility between our press tools and the established fitting system can be checked.

The app is available in German or English.



**App for smartphone and tablet**  
For easy verification of the compatibility of press tools.  
**Available for iOS and Android!**








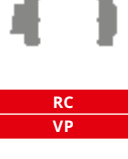



App Store



Google Play

OVERVIEW ALSO AVAILABLE ONLINE!

	Nominal size	Press jaws compact	Press jaws standard	Interchangeable insert compact Use only in combination with interchangeable jaws (No. 1000002134)	Anpro EN Series Stainless Steel, Carbon Steel	APE Raccordi a pressare	Bampi BALPEX (Serie MP)	Bampi BALPEX Gas	Blansol Sistema EasyPress	Blansol Sistema Multiplex	Bonomi Group Turbo Press, Turbo Press Gas	Broen Ballofix Pres	Chibro Adduzione / Gas, Como Galvanized	Chibro Cunipres, Riscaldamento	CIMBERTO SpA Cimpres	CO.E.S. Coesklima	COMAP, Skin Press	Comisa Multi layer pipe	Conex Bänninger >B< Press Gas, Solar	Conex Bänninger >B< Press INOX	DALPEX LaserMulti Dalpex	Emmeti Gerpex	EMPUR PEXPRESS	Eurotherm, MULTISTRATO, Euro 2000	
	M	M12	015151X	015101X																					
		M15	015152X	015102X																					
		M18	015153X	015103X																					
		M22	015154X	015104X																					
		M28	015155X	015105X																					
		M35	1000002267	015106X																					
		M42		1000001273																					
	M54		1000001274																						
	V/SV	V12	015261X	015211X																					
		SV14	015269X	015219X																					
		SV15	015262X	015212X																					
		SV16	015260X	015220X																					
		SV18	015263X	015213X																					
		SV22	015264X	015214X																					
		SV28	015265X	015215X																					
		SV35	1000002266	015216X																					
		SV42		015217X																					
		SV54		015218X																					
	G	G16	015362X	015302X																					
		G20	015364X	015304X																					
		G26	015366X	015306X																					
		G32	015367X	015307X																					
		G40	015368X	015308X																					
		HA16	015580X	015280X																					
	HA	HA20	015581X	015281X																					
		HA26	015582X	015282X																					
		HA32	015583X	015283X																					
		HA40		015284X																					
		R12		015339X	14863																				
		R14	015370X	015330X																					
	R(H)	R16	015371X	015331X	14865																				
		R17	015378X	015333X																					
		R18	015379X	015334X																					
		R20	015374X	015335X	14868																				
		R25	015380X	015338X																					
		R26	015376X	015336X	14708																				
		R32	015377X	015337X																					
		RFz12		1000000173	14822																				
		RFz	RFz16	015180X	015161X	14823																			
			RFz20	015181X	015162X	14824																			
		RFz25	015182X	015163X	14825																				
		RFz32	015183X	015164X	14826																				
		TH14	015395X	015321X	14842																				
	TH	TH16	015385X	015322X	14843																				
		TH18	015398X	015323X	14844																				
		TH20	015389X	015324X	14845																				
		TH25	015399X	015325X	14846																				
		TH26	015391X	015326X	14847																				
		TH32	015393X	015327X	14848																				
		TH40	015401X	015328X																					
		THG32	1000000236	1000000235																					
	THT32	1000004620	015329X																						
	U	U14	015351X	015311X	14832																				
		U16	015352X	015312X	14833																				
		U18	015353X	015313X	14834																				
		U20	015354X	015314X	14835																				
		U25	015355X	015315X	14836																				
		U32	015357X	015317X	14838																				
		U40	015358X	015318X																					
	RC	RC26	015277X	015271X	14837																				
	VP	VP14	015530X	015230X	14882																				
		VP16	015531X	015231X	14883																				
		VP20	015532X	015232X	14884																				
		VP25	015533X	015233X	14885																				
		VP32	015534X	015234X	14886																				


The above release table reflects the status quo at the time this catalogue went to press, which may be subject to technical changes. For latest compatibility information, please check out the ROTHENBERGER Pressnavigator app for your smartphone.

OVERVIEW ALSO AVAILABLE ONLINE!

	Nominal size	Press jaws compact	Press jaws standard	Interchangeable insert compact Use only in combination with interchangeable jaws (No. 100000213-4)	Eurotubi Pressfitting System	F.B.Q. BARONIO B Q pres	Frabo Frabopress C Steel, 316	Frabo MULTI-BRASS	FRÄNKISCHE, ALPEX F50	Gabo, Gabopress H+5	GAROS	Geberit Mapress Gas	Geberit Mapress Stainless	Geberit Mapress Copper Carbon steel	Geberit Mepla	Giacomini Giacomflex, Gosco Therm	HAKA, Fimisol, HAKAP-RES, HAKA, GERODUR	Harden 2000, Polypex 2000	Henco PVDF	Herz pipefix	HIDROTEC KLIMATEC	Hitec Sistema, Multistrato	IBP > B - Press Rotguss, Inox	
	M	M12	015151X	015101X								●	●	●										
		M15	015152X	015102X	●							●	●	●										
		M18	015153X	015103X	●							●	●	●										
		M22	015154X	015104X	●							●	●	●										
		M28	015155X	015105X	●							●	●	●										
		M35	1000002267	015106X		●						●	●	●										
		M42		1000001273									●	●	●									
	M54		1000001274									●	●											
	V/SV	V12	015261X	015211X			●																	
		SV14	015269X	015219X			●	●																
		SV15	015262X	015212X			●	●																
		SV16	015260X	015220X			●	●																
		SV18	015263X	015213X			●	●																
		SV22	015264X	015214X			●	●															●	
		SV28	015265X	015215X			●	●															●	
		SV35	1000002266	015216X			●	●															●	
		SV42		015217X			●	●															●	
		SV54		015218X			●	●															●	
	G	G16	015362X	015302X											●									
		G20	015364X	015304X											●									
		G26	015366X	015306X											●									
		G32	015367X	015307X											●									
		G40	015368X	015308X											●									
		G40	015368X	015308X											●									
	HA	HA16	015580X	015280X																				
		HA20	015581X	015281X																				
		HA26	015582X	015282X																				
		HA32	015583X	015283X																				
		HA40		015284X																				
		HA40		015284X																				
	R(H)	R12		015339X	14863																			
		R14	015370X	015330X																				
		R16	015371X	015331X	14865				●															
		R17	015378X	015333X																				
		R18	015379X	015334X																				
		R20	015374X	015335X	14868				●															
		R25	015380X	015338X																				
		R26	015376X	015336X	14708					●														
		R32	015377X	015337X						●														
	RFz	RFz12		1000000173	14822																			
		RFz16	015180X	015161X	14823																			
		RFz20	015181X	015162X	14824																			
		RFz25	015182X	015163X	14825																			
		RFz32	015183X	015164X	14826																			
	TH	TH14	015395X	015321X	14842			●		●	●					●		●	●	●		●		
		TH16	015385X	015322X	14843				●	●	●					●		●	●	●	●		●	
		TH18	015398X	015323X	14844					●	●					●		●	●	●	●		●	
		TH20	015389X	015324X	14845			●	●	●	●					●		●	●	●	●		●	
		TH25	015399X	015325X	14846					●	●					●		●	●	●	●		●	
		TH26	015391X	015326X	14847					●	●					●		●	●	●	●		●	
		TH32	015393X	015327X	14848			●	●	●	●					●		●	●	●	●		●	
		TH40	015401X	015328X						●	●					●		●	●	●	●		●	
		TH40	015401X	015328X						●	●					●		●	●	●	●		●	
	THG	THG32	1000000236	1000000235												●								
	THT	THT32	1000004620	015329X														●						
	U	U14	015351X	015311X	14832																			
		U16	015352X	015312X	14833																			
		U18	015353X	015313X	14834																			
		U20	015354X	015314X	14835			●	●														●	
		U25	015355X	015315X	14836			●	●														●	
		U32	015357X	015317X	14838			●	●														●	
		U40	015358X	015318X																			●	
		U40	015358X	015318X																			●	
	RC	RC26	015277X	015271X	14837																			
	VP	VP14	015530X	015230X	14882																			
		VP16	015531X	015231X	14883																			
		VP20	015532X	015232X	14884																			
		VP25	015533X	015233X	14885																			
		VP32	015534X	015234X	14886																			

The above release table reflects the status quo at the time this catalogue went to press, which may be subject to technical changes. For latest compatibility information, please check out the ROTHENBERGER Pressnavigator app for your smartphone.

OVERVIEW ALSO AVAILABLE ONLINE!

	Nominal size	Press jaws compact	Press jaws standard	Interchangeable insert compact Use only in combination with interchangeable jaws (No. 1000002134)	IBP > B < PRESS, > B < PRESS GAS	IPA, IPANA-PRES	IPALPEX	IVAR MP / PMP	Jaraflex-presssystem	Jupiter, Heizsysteme	KE KELIT KELOX	KOHLER, InoxPress	LAVAGRUND, LAVAPRESS	Mair Heiztechnik, Gomafix	Markkg, polymark	MEGARO HAKAPRESS	MULTITHERM PRESSSYSTEM	Multitubo Giacomini	NEUTHERM, MEKUPRESS	Nupi MultiNupi	Nussbaum Cupress, Optipress	Nussbaum CupressG	Nussbaum, Optiflex Plus	Oventrop, Cofit
<b>M</b>	M12	015151X	015101X																					
	M15	015152X	015102X																					
	M18	015153X	015103X																					
	M22	015154X	015104X																					
	M28	015155X	015105X																					
	M35	1000002267	015106X																					
	M42		1000001273																					
<b>V/SV</b>	M54		1000001274																					
	V12	015261X	015211X																					
	SV14	015269X	015219X																					
	SV15	015262X	015212X																					
	SV16	015260X	015220X																					
	SV18	015263X	015213X																					
	SV22	015264X	015214X																					
<b>G</b>	SV28	015265X	015215X																					
	SV35	1000002266	015216X																					
	SV42		015217X																					
	SV54		015218X																					
	G16	015362X	015302X																					
	G20	015364X	015304X																					
	G26	015366X	015306X																					
<b>HA</b>	G32	015367X	015307X																					
	G40	015368X	015308X																					
	HA16	015580X	015280X																					
	HA20	015581X	015281X																					
<b>R(H)</b>	HA26	015582X	015282X																					
	HA32	015583X	015283X																					
	HA40		015284X																					
	R12		015339X	14863																				
	R14	015370X	015330X																					
	R16	015371X	015331X	14865																				
	R17	015378X	015333X																					
	R18	015379X	015334X																					
	R20	015374X	015335X	14868																				
	R25	015380X	015338X																					
<b>RFz</b>	R26	015376X	015336X	14708																				
	R32	015377X	015337X																					
	RFz12		1000000173	14822																				
	RFz16	015180X	015161X	14823																				
	RFz20	015181X	015162X	14824																				
<b>TH</b>	RFz25	015182X	015163X	14825																				
	RFz32	015183X	015164X	14826																				
	TH14	015395X	015321X	14842																				
	TH16	015385X	015322X	14843																				
	TH18	015398X	015323X	14844																				
	TH20	015389X	015324X	14845																				
	TH25	015399X	015325X	14846																				
	TH26	015391X	015326X	14847																				
	TH32	015393X	015327X	14848																				
<b>THG</b>	TH40	015401X	015328X																					
	THG32	1000000236	1000000235																					
<b>U</b>	THT	THT32	1000004620	015329X																				
	U14	015351X	015311X	14832																				
	U16	015352X	015312X	14833																				
	U18	015353X	015313X	14834																				
	U20	015354X	015314X	14835																				
	U25	015355X	015315X	14836																				
	U32	015357X	015317X	14838																				
<b>RC</b>	U40	015358X	015318X																					
	RC26	015277X	015271X	14837																				
	<b>VP</b>	VP14	015530X	015230X	14882																			
		VP16	015531X	015231X	14883																			
		VP20	015532X	015232X	14884																			
		VP25	015533X	015233X	14885																			
VP32	015534X	015234X	14886																					

The above release table reflects the status quo at the time this catalogue went to press, which may be subject to technical changes. For latest compatibility information, please check out the ROTHENBERGER Pressnavigator app for your smartphone.


**OVERVIEW ALSO AVAILABLE ONLINE!**

		Nominal size	Press jaws compact	Press jaws standard	Interchangeable insert compact Use only in combination with interchangeable jaws (No. 1000002134)	PIPELIFE RADOPRESS	POLYSAN Press-System	Prandelli, MULTYRAMA	Raccorderie Metalliche Inoxpress, Steelpress	Raccorderie Metalliche Aespres	Raccorderie Metalliche, Inoxpress Gas	RIQUJERA A SERTIR	ROTH SISTEMA ROTH A-PRESS	Roth-Roth Rohrinstallations-systeme	Roth Alu-Laserplus	Sanha 3ft-PRESS SYSTEM 14-63 mm	SANHA NiroSan Serie 9000, 17000 Gas, 18000, 19000	SANHA Press Serie 10000, 11000 Gas, 12000, 13000	SANHA PURAPRESS Serie 8000	SANHA-NiroSan-Presssystem Chronimo	Simplex SIROCon Cu/E	Simplex SIROCon PPSU H	Simplex SIROCon PPSU TH	SST-Rolltec Delphi-Press, STS Systemtechnik	THERMOVAL, THERMOSMART	Tiemme, Cobrapress		
<b>M</b>		M12	015151X	015101X																								
		M15	015152X	015102X																								
		M18	015153X	015103X																								
		M22	015154X	015104X																								
		M28	015155X	015105X																								
		M35	1000002267	015106X																								
		M42		1000001273																								
<b>V/SV</b>		V12	015261X	015211X																								
		SV14	015269X	015219X																								
		SV15	015262X	015212X																								
		SV16	015260X	015220X																								
		SV18	015263X	015213X																								
		SV22	015264X	015214X																								
		SV28	015265X	015215X																								
		SV35	1000002266	015216X																								
		SV42		015217X																								
		SV54		015218X																								
<b>G</b>		G16	015362X	015302X																								
		G20	015364X	015304X																								
		G26	015366X	015306X																								
		G32	015367X	015307X																								
		G40	015368X	015308X																								
<b>HA</b>		HA16	015580X	015280X																								
		HA20	015581X	015281X																								
		HA26	015582X	015282X																								
		HA32	015583X	015283X																								
		HA40		015284X																								
<b>R(H)</b>		R12		015339X	14863																							
		R14	015370X	015330X	14864																							
		R16	015371X	015331X	14865																							
		R17	015378X	015333X	14866																							
		R18	015379X	015334X	14867																							
		R20	015374X	015335X	14868																							
		R25	015380X	015338X	14707																							
		R26	015376X	015336X	14708																							
		R32	015377X	015337X	14709																							
		RFz		1000000173	14822																							
<b>RFz</b>		RFz12		015161X	14823																							
		RFz16	015180X	015162X	14824																							
		RFz20	015181X	015163X	14825																							
		RFz25	015182X	015164X	14826																							
		RFz32	015183X	015321X	14842																							
<b>TH</b>		TH14	015395X	015322X	14843																							
		TH16	015385X	015323X	14844																							
		TH18	015398X	015324X	14845																							
		TH20	015389X	015325X	14846																							
		TH25	015399X	015326X	14847																							
		TH26	015391X	015327X	14848																							
		TH32	015393X	015328X	14886																							
		TH40	015401X																									
<b>THG</b>	THG32	1000000236	1000000235																									
<b>THT</b>	THT32	1000004620	015329X																									
<b>U</b>		U14	015351X	015311X	14832																							
		U16	015352X	015312X	14833																							
		U18	015353X	015313X	14834																							
		U20	015354X	015314X	14835																							
		U25	015355X	015315X	14836																							
		U32	015357X	015317X	14838																							
		U40	015358X	015318X																								
<b>RC</b>		RC26	015277X	015271X	14837																							
		VP14	015530X	015230X	14882																							
<b>VP</b>		VP16	015531X	015231X	14883																							
		VP20	015532X	015232X	14884																							
		VP25	015533X	015233X	14885																							
		VP32	015534X	015234X	14886																							

The above release table reflects the status quo at the time this catalogue went to press, which may be subject to technical changes. For latest compatibility information, please check out the ROTHENBERGER Pressnavigator app for your smartphone.



OVERVIEW ALSO AVAILABLE ONLINE!

	Nominal size	Press jaws compact	Press jaws standard	Interchangeable insert compact Use only in combination with interchangeable jaws (No. 1000002134)	Tradesa Serie 700	Ulrich VARIOFLEX HAKA-PRESS	UPONOR UNIPiPE, UNI-CORE, Airpipe	UPONOR SPress Plus	Valsir PEXAL	Vescal, Metalplast	Viega Profipress G	Viega Profipress Sanpress, Sanpress INOX	Viega sanfix FOSTA, P, PLUS	Viessmann	VSH X-Press Carbon Stainless, Copper	VSH SudoPress Carbon Stainless, Copper	VSH Skin Press	VSH Skin Press PPSU, Skin Press Gas	Watts MTR Art press	Wavin Aquatecnic Tigris	Wavin FUTURE 1/2, TIGRIS Alupex/Blue	WEFA PLASTIC, WEFA PRESS	Winkler	WKS-Press
<b>M</b>	M12	015151X	015101X												•									
	M15	015152X	015102X												•									
	M18	015153X	015103X												•									
	M22	015154X	015104X												•									
	M28	015155X	015105X												•									
	M35	1000002267	015106X												•									
	M42		1000001273												•									
<b>V/SV</b>	M54		1000001274											•										
	V12	015261X	015211X																					
	SV14	015269X	015219X								•	•												
	SV15	015262X	015212X								•	•												
	SV16	015260X	015220X								•	•												
	SV18	015263X	015213X								•	•												
	SV22	015264X	015214X								•	•												
	SV28	015265X	015215X								•	•												
	SV35	1000002266	015216X								•	•												
	SV42		015217X								•	•												
<b>G</b>	SV54		015218X							•	•													
	G16	015362X	015302X																					
	G20	015364X	015304X																					
	G26	015366X	015306X																					
	G32	015367X	015307X																					
	G40	015368X	015308X																					
	<b>HA</b>	HA16	015580X	015280X												•								
HA20		015581X	015281X												•									
HA26		015582X	015282X												•									
HA32		015583X	015283X												•									
HA40			015284X												•									
<b>R(H)</b>	R12		015339X	14863																				
	R14	015370X	015330X	14864																				
	R16	015371X	015331X	14865		•																		
	R17	015378X	015333X	14866		•																		
	R18	015379X	015334X	14867		•																		
	R20	015374X	015335X	14868		•																		
	R25	015380X	015338X	14707																				
	R26	015376X	015336X	14708		•																		
	R32	015377X	015337X	14709		•																		
	<b>RFz</b>	R32		015337X	14709		•																	
RFz12			1000000173	14822																				
RFz16		015180X	015161X	14823																				
RFz20		015181X	015162X	14824																				
RFz25		015182X	015163X	14825																				
<b>TH</b>	RFz32	015183X	015164X	14826																				
	TH14	015395X	015321X	14842											•									
	TH16	015385X	015322X	14843		•									•									
	TH18	015398X	015323X	14844		•									•									
	TH20	015389X	015324X	14845		•									•									
	TH25	015399X	015325X	14846		•									•									
	TH26	015391X	015326X	14847											•									
	TH32	015393X	015327X	14848		•									•									
	TH40	015401X	015328X												•									
<b>THG</b>	THG32	1000000236	1000000235																					
	THT	THT32	1000004620	015329X																				
<b>U</b>	U14	015351X	015311X	14832																				
	U16	015352X	015312X	14833																				
	U18	015353X	015313X	14834																				
	U20	015354X	015314X	14835																				
	U25	015355X	015315X	14836																				
	U32	015357X	015317X	14838																				
	U40	015358X	015318X																					
	<b>RC</b>	RC26	015277X	015271X	14837																			
<b>VP</b>		VP14	015530X	015230X	14882																			
		VP16	015531X	015231X	14883											•								
		VP20	015532X	015232X	14884											•								
		VP25	015533X	015233X	14885											•								
		VP32	015534X	015234X	14886											•								
																•								
														•										

The above release table reflects the status quo at the time this catalogue went to press, which may be subject to technical changes. For latest compatibility information, please check out the ROTHENBERGER Pressnavigator app for your smartphone.





## Threading and grooving



<b>System overview</b>	<b>148-149</b>
Threading manual	150-153
Threading electric	154-165
Accessories threading	167
Roll grooving	168-169

**Threader manual**

**SUPER CUT**

**SANI KIT**



Operation mode	Handed / manual	Handed / manual
Working range	Ø 1/4-2"	Ø 1/2-1"
Handle	up to 3 pcs.	2 pcs
Thread type	BSPP, BSPT R, BSW, Metric, NPT	BSPP, BSPT R, BSW, Metric, NPT
Number of die heads	up to 7 pcs.	3 pcs.
<b>Page</b>	<b>150</b>	<b>152</b>

6

**Threader electric**

**SUPERTRONIC 1250**

**SUPERTRONIC 2000 E**

**SUPERTRONIC 2000**



Operation mode	Handed / electric	Handed / electric	Handed / electric
Working range	Ø 1/4-1. 1/4"	Ø 1/4-2"	Ø 1/4-2"
Thread type	BSPP, BSPT R, BSW, Metric, NPT	BSPP, BSPT R, BSW, Metric, NPT	BSPP, BSPT R, BSW, Metric, NPT
Number of die heads	4 pcs.	6 pcs.	6 pcs.
Power	750 W	○	1,010 W
<b>Page</b>	<b>154</b>	<b>156</b>	<b>158</b>

**Threader stationary**

**ROPOWER 50R**

**SUPERTRONIC 2 SE**

**SUPERTRONIC 3 SE**

**SUPERTRONIC 4 SE**



Operation mode	Stationary	Stationary	Stationary	Stationary
Working range	Ø 1/4-2"	Ø 1/4-2"	Ø 1/4-2"	Ø 1/4-4"
Thread type	BSPP, BSPT R, BSW, Metric, NPT	BSPP, BSPT R, BSW, Metric, NPT	BSPP, BSPT R, BSW, Metric, NPT	BSPP, BSPT R, BSW, Metric, NPT
Number of die heads	1 pcs.	1 pcs.	2 pcs.	2 pcs.
Number of threading dies	2 pcs.	2 pcs.	3 pcs.	3 pcs.
Power	1,150W	1,150W	1,700W	1,750W
<b>Page</b>	<b>162</b>	<b>164</b>	<b>164</b>	<b>164</b>

6

**Roll grooving machines**

**Hand ROLL GROOVER 1-12"**

**ROGROOVER 1-6"**

**ROGROOVER 1-12"**



Operation mode	Handed-manual / Handed-electric	Handed-electric / Stationary	Stationary
Working range	Ø 1-12"	Ø 1-6"	Ø 1-12"
Drive unit	SUPERTRONIC 1250 / 2000	SUPERTRONIC 2000 / 2-4 SE	Motor
Wall thickness	up to 10 mm	up to 10 mm	up to 10 mm
Pressure rollers included	1 pcs.	1 pcs.	3 pcs.
Power	800W / 1,010W	1,010W / max. 1,750W	1,500W
Transportation frame	○	○	optional
<b>Page</b>	<b>168</b>	<b>168</b>	<b>169</b>

**SUPER CUT**

**Ratchet threader Ø 1/4-2"**

For production of precise and reliable thread connections according EN 10226 on threaded pipe according EN 10255 M/H

**Application Benefits**

- Slim, compact design with excellent overall size, ratchet angle of 22.5°
- Easy operation in hard-to-reach places with the offset lever
- Convenient, lockable reversal of the ratchet direction
- Extremely long service life
- Simple insertion and removal of die heads
- Secure hold with retainer locking
- Perfect centering through the long pipe guide is ensured
- Optimised cutting geometry allows a gentle first cut and excellent chip discharge



**Power optimisation with the offset hand lever!**

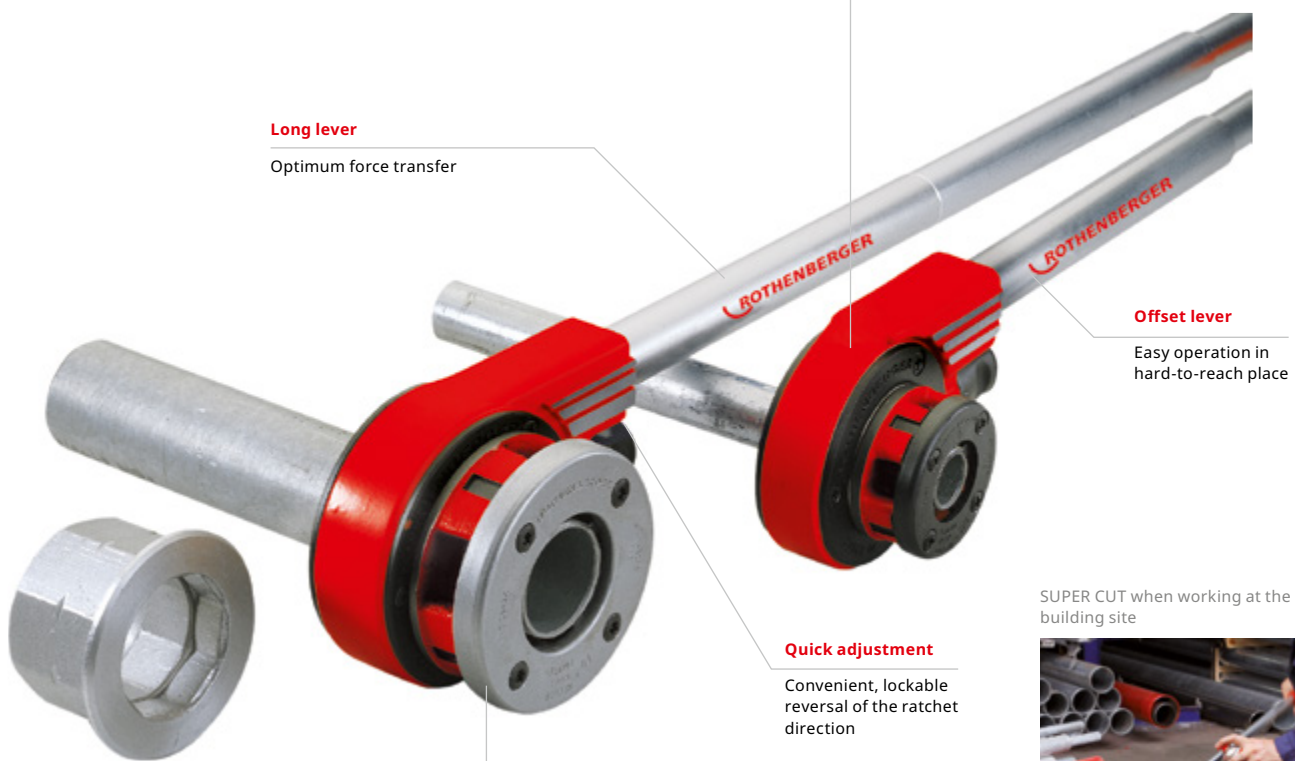
**Quick change die heads**

**Secure hold**

Positive octagonal universal drive with retainer locking

**Fits all ROTHENBERGER manual and power threaders**

Simple insertion and removal of the die heads



**Long lever**  
Optimum force transfer

**Offset lever**  
Easy operation in hard-to-reach place

**Quick adjustment**  
Convenient, lockable reversal of the ratchet direction

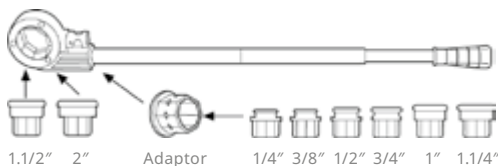
**Made of high quality tempered steel**  
Extremely long service life

SUPER CUT when working at the building site



Monoblock adaptor (No. 600011500)

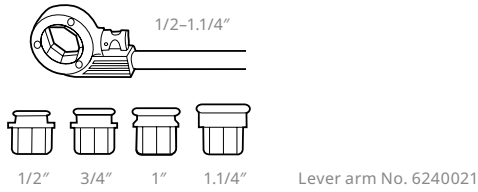
With ratchet handle 1/4"-2" the attachment of the 1/4"-1.1/4" die head results with the use of the adaptor (No. 600011500)



6

**SUPER CUT sets 1/2-1.1/4"**

With ratchet handle (small octagonal drive, No. 070840X) and die heads in plastic carrying case (No. 70780)

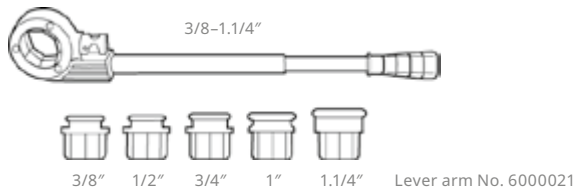


Model	Weight	PU	No.
BSPT R, 1/2-3/4-1"	4.200 kg	1	070780X
BSPT R, 1/2-3/4-1-1.1/4"	5.100 kg	1	070781X

Model	Weight	PU	No.
NPT, 1/2-3/4-1"	4.800 kg	1	070903X <sup>1</sup>
NPT, 1/2-3/4-1-1.1/4"	5.450 kg	1	070901X <sup>1</sup>

**SUPER CUT sets 3/8-1.1/4"**

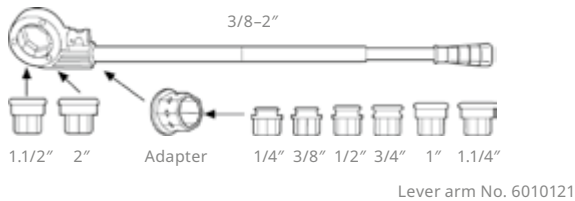
With ratchet handle (small octagonal drive, No. 070840X) and die heads in ROCASE 4414 (No. 1300003541)



Model	Weight	PU	No.
BSPT R, 3/8-1/2-3/4-1-1.1/4"	6.200 kg	1	070790X

**SUPER CUT sets 3/8-2"**

With ratchet handle (large octagonal drive, No. 71272), die head adaptor (No. 71273) and die heads in ROCASE 4414 (No. 1300003541)



Model	Weight	PU	No.
BSPT R, 3/8-1/2-3/4-1-1,1/4-1,1/2-2"	11.400 kg	1	070891X
BSPT R, 1/2-3/4-1-1,1/4-1,1/2-2"	10.800 kg	1	070892X

Model	Weight	PU	No.
BSPT R, 1-1.1/4-1.1/2-2"	9.820 kg	1	070894X
NPT, 3/8-1/2-3/4-1-1.1/4-1.1/2-2"	11.400 kg	1	070904X
NPT, 1/2-3/4-1-1.1/4-1.1/2-2"	10.800 kg	1	070905X

**Accessories**

**Page**

Die heads 1/4-2"	160
Dies 1/4-2"	160
Cutting fluid	161
Pipe roughing wrench	167
Ratchet pipe deburrer 1/4-2"	167



1) in ROCASE 4414 (No. 1300003541)

### SANI KIT Tool carrying case

#### Tool set in sturdy plastic carrying case

Ideal for repair and installation jobs requiring complete steel pipe processing

**Cutting:** Up to Ø 1.1/4"

**Thread cutting:** Up to Ø 1"

**Assembly, screwing, loosening, sealing of thread connections:** Up to Ø 1.1/4"

#### Application Benefits

- Light and easy to use, always within reach
- Secure guiding of the cutter wheel on the pipe
- Reliable grip with the s-shaped jaw
- Firm grip even with heavy-duty use
- Long service life
- Precise thread cutting to approved standards
- Perfect alignment

The ideal installation set!



SANI KIT when working at the building site with RONOL



### Steel pipe cutter Super 1.1/4"

#### Wide rollers

Secure guiding of the cutter wheel on the pipe

### Corner pipe wrench Super S

#### Slim, s-shaped jaw

Firm grip



### SUPER CUT ratchet threader

With SUPER CUT ratchet handle 1.1/4"

Perfect alignment

Small outer octagon, BSPT R 1/2-3/4-1"

Precise thread cutting to approved standards

### Water pump pliers type SP

With heavy duty box joint, chrome vanadium steel, drop-forged and tempered

Long service life

Polished head and joint

Firm grip even with heavy-duty use

10-part set (No. 70600) includes: SUPER CUT ratchet threader 1.1/4" (No. 070840X), quick-change die heads BSPT R 1/2" (No. 070823X) - 3/4" (No. 070824X) - 1" (No. 070825X), steel pipe cutter SUPER 1.1/4" (No. 70040), water pump pliers type SP 10" (No. 70528), corner pipe wrench 1" (No. 070122X) as well as teflon tape (No. 855360), in plastic carrying case

Model	Weight	PU	No.
SANI KIT Tool carrying case	8.200 kg	1	70600



## Ratchet arm for SUPER CUT

### Ratchet threader Ø 1/4–1.1/4"

For production of precise and reliable thread connections according to EN 10226 on threaded pipe according to EN 10255 M/H

#### Application Benefits

- Slim, compact design with excellent overall size, ratchet angle of 22.5°
- Easy operation in hard-to-reach places with the offset lever
- Convenient, lockable reversal of the ratchet direction
- Extremely long service life
- Simple insertion and removal of die heads
- Secure hold with retainer locking
- Perfect centering through the long pipe guide is ensured
- Optimised cutting geometry allows a gentle first cut and excellent chip discharge

#### Fits all ROTHENBERGER manual and power threaders

Simple insertion and removal of the die heads

#### Secure hold

Positive octagonal universal drive with retainer locking

#### Long lever

Optimum force transfer

#### Offset lever

Easy operation in hard-to-reach places

#### Made of high quality tempered steel

Extremely long service life

#### Quick adjustment

Convenient, lockable reversal of the ratchet direction

Model	Weight	PU	No.
Ratchet arm for SUPER CUT 1/4–1.1/4", 2 pieces	1.700 kg	1	070840X



#### Accessories

#### Page

Die heads 1/4–2"	160
Dies 1/4–2"	160
Cutting fluid	161
Pipe roughing wrench	167
Ratchet pipe deburrer 1/4–2"	167



## Threading and grooving

### Threading electric

#### SUPERTRONIC 1250

##### Electric threading die $\varnothing$ 1/4–1.1/4"

For fast and effortless production of precise, standard-compliant and secure threaded connections

For thread cutting of

**BSPT right:**  $\varnothing$  1/2–1.1/4"

**Optional (not included in the set):**  $\varnothing$  1/4", 3/8"

**NPT:**  $\varnothing$  1/4–1.1/4"



#### Application Benefits

- Ideal for confined spaces (corners, shafts)
- Sturdy and light, even with heavy-duty use
- Compact gear housing with excellent overall size
- High power transmission, quiet running with long service life
- Tough, rugged and durable
- Weight reduction and easy handling
- Die head can be used in both directions (left and right)
- Stable speed by forward and reverse motion

#### Technical Data

Working area	$\varnothing$ 1/4–1.1/4"
Cutting speed	15–20 m/s
Sound pressure level	92 dB
Sound power level (LwA)	103 dB
Power consumption	750 W
Rapid reverse speed	27 m/s
Vibration	1.02 m/s <sup>2</sup>
Thread type	BSPP, BSPT R, BSW, Metric, NPT



Ideal for portable operation due to its compact design and weight of only 4.9 kg



Small head shape (11 cm)



Pipe roughing



**SUPERTRONIC 1250 sets**

**Small—Fast—Light**

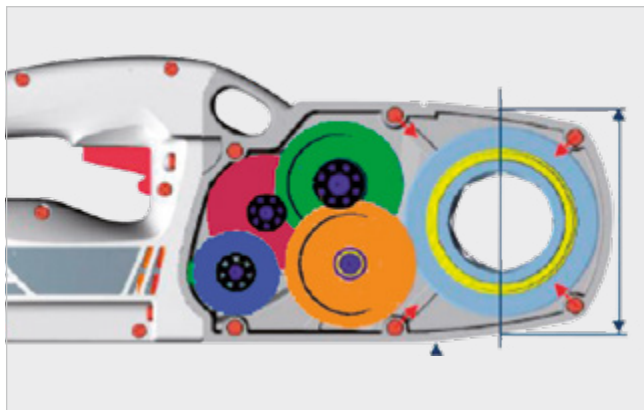
Set includes: SUPERTRONIC 1250 up to Ø 1.1/4" with forged pipe clamp (No. 865008700), precision die heads complete in plastic carrying case (No. 995858100)



Fig. SUPERTRONIC 1250 set (No. 71450)

Model	Weight	PU	No.
SUPERTRONIC 1250 set with pipe clamp	3.900 kg	1	71470
SUPERTRONIC 1250 set BSPT R 1/2–3/4–1–1.1/4", 230 V	12.970 kg	1	71450
SUPERTRONIC 1250 set NPT 1/2–3/4–1–1.1/4", 220 V	13.000 kg	1	71454
SUPERTRONIC 1250 set NPT 1/2–3/4–1–1.1/4", 110 V	13.000 kg	1	71453
Counterholder	1.600 kg	1	865008700

Helical gears for maximum power (800 W)



Portable, fast and easy steel pipe processing



Accessories	Page
Die heads 1/4–2"	160
Dies 1/4–2"	160
Cutting fluid	161
Pipe roughing wrench	167
Ratchet pipe deburrer 1/4–2"	167



### SUPERTRONIC 2000 E

#### Battery driven power threader Ø 1/4–2"

For quick and effortless production of precise and reliable thread connections to approved standards

For threading of  
**BSPT right: Ø 1/4–2"**

#### Application Benefits

- 4-times faster retraction due to reverse gear unit
- User-friendly operation thanks to large changeover switch for forward and reverse motion
- Firm seating of the cutting heads due to direct mounting with snap ring locking
- Thread cutting close to the wall due to off-center cutting heat cutting head mounting
- Ideal for hard-to-reach places (corners, shafts)
- Secure hold in both directions of rotation due to hardened, prism toothed counterholder
- Easy to maintain thanks to permanent lubrication and brushless motor

#### Technical Data

Working area	Ø 1/4–2" (13–60 mm)
System battery	CAS or AMPShare
Cutting speed	15–25 rpm
Sound pressure level	87 dB
Sound power level (LWA)	100 dB
Rapid reverse speed	58 rpm



Available in the manufacturer-independent battery systems AMPShare – Powered by Bosch or CAS – CORDLESS ALLIANCE SYSTEM

#### Toolless Speed-Lock die head mounting

For a fast and fixed connection

#### Compact and rectangular construction

Optimized for places, that are hard to reach, like corners or shafts, and for working safely on a work bench

#### Brushless motor

For wear-free work and longer machine life

#### Multiple battery systems

Suitable for AMPShare or CAS battery systems

#### Off-set die head mounting

Threading possible even close to walls

#### DuraEasyCut

Optimized geometry for reduced effort of up to 20% for person and machine

#### Easy switching from forward to an even faster reverse

For working more efficiently

Easy insertion of the die head with tension locking ring



Compatible with with rolling groover ROGROOVER 1–6"



Work in confined spaces



**SUPERTRONIC 2000 E sets**

Set includes: SUPERTRONIC 2000 E basic device, pipe clamp (No. 71280), ROFIX adaptor (No. 71271), ROCASE 6414 with inlay (No. 1000001953)

**Can also be used as a drive for our roll grooving unit!**



Fig. SUPERTRONIC 2000 E set (No. 1000003387)

Fig. Hand roll groover 1-12" (No. 1000000212)

Model	Weight	PU	AMPShare-No.	CAS-No.
SUPERTRONIC 2000 E bare tool with pipe clamp	9.800 kg	1	1000004184	1000003387
SUPERTRONIC 2000 E set with pipe clamp, without battery, without charger, BSPT R 1/2-3/4-1-1.1/2-2"	12.200 kg	1	1000004185	1000003388
SUPERTRONIC 2000 E set with pipe clamp, 4 Ah battery, charger, BSPT R 1/2-3/4-1-1.1/4-1.1/2-2"	18.100 kg	1	1000004186	1000003389

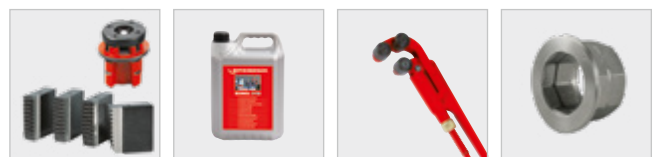


**Batteries and charger**

AMPShare	Weight	PU	No.	CAS	Weight	PU	No.
RO BP18/2, 2.0 Ah 18V	0.400 kg	1	1000003859	RO BP18/2, 2.0 Ah 18V	0.420 kg	1	1000001652
RO BP18/4, 4.0 Ah 18V	0.600 kg	1	1000003860	RO BP18/4, 4.0 Ah 18V	0.575 kg	1	1000001653
RO BP18/4, 4.0 Ah 18V, ProCORE	0.520 kg	1	1000003863	RO BP18/4, 4.0 Ah 18V, Li-HD	0.515 kg	1	1000002548
RO BP18/8, 8.0 Ah 18V, ProCORE	0.960 kg	1	1000003864	RO BP18/8, 8.0 Ah 18V, Li-HD	0.915 kg	1	1000002549
RO BC18 charger, 230V	0.550 kg	1	1000003858	RO BC14/36 charger, 230V	0.580 kg	1	1000001654

**Accessories**

	Page
Die heads 1/4-2"	160
Dies 1/4-2"	160
Cutting fluid	161
Pipe roughing wrench	167
Ratchet pipe deburrer 1/4-2"	167



**SUPERTRONIC 2000**

**Power threader Ø 1/4–2"**

For quick and effortless production of precise and reliable thread connections to approved standards

For threading of  
**BSPT right:** Ø 1/4–2"  
**NPT:** Ø 1/4–2"

**Application Benefits**

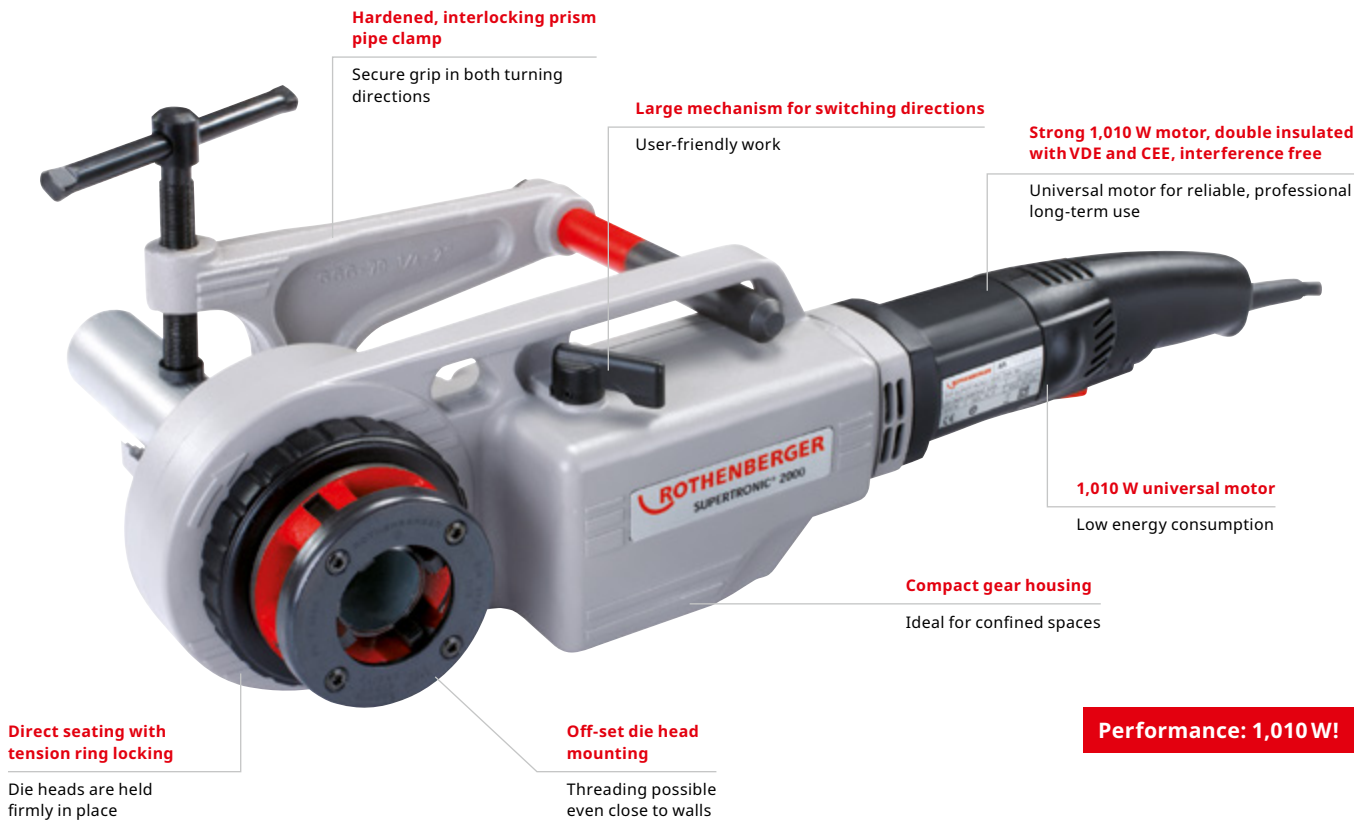
- Secure grip in both turning directions with the hardened, interlocking prism pipe clamp
- Die heads are held firmly in place through direct seating with tension ring locking
- Off-set die head mounting allows for threading even close to walls
- Ideal for confined spaces (corners and shafts)
- User-friendly work with the large mechanism for switching directions
- Reliable motor for long-term use



**Technical Data**

Working area	Ø 1/4–2"
Cutting speed	15–25 m/s
Sound pressure level	100 dB
Sound power level (LwA)	87 dB
Power consumption	1,010 W
Rapid reverse speed	58 bpm
Vibration	3.02 m/s <sup>2</sup>
Thread type	BSPP, BSPT R, BSW, Metric, NPT

6



Easy insertion of the die heads



Use with roll grooving tool ROGROOVER



ROFIX adaptor (No. 71271)



High reduction gears



**SUPERTRONIC 2000 sets**

Set includes: SUPERTRONIC 2000 with pipe clamp (No. 71280), ROFIX adaptor (No. 71271), and precision die heads, ROCASE 6414 (No. 1000001953) with inlay

Can also be used in combination with a roll grooving tool!



Pipe clamp

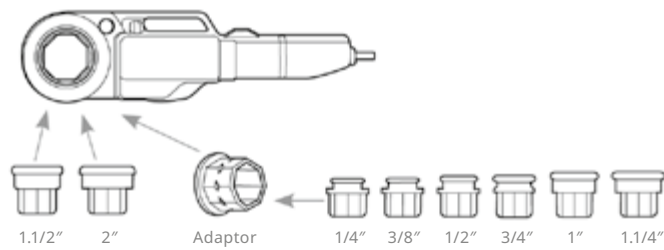


Fig. SUPERTRONIC 2000 set (No. 71257)

**Model**

	<b>Weight</b>	<b>PU</b>	<b>No.</b>
SUPERTRONIC 2000 set BSPT R 1/2-3/4-1-1.1/4-1.1/2-2", 230 V	14.500 kg	1	71256
SUPERTRONIC 2000 set NPT 1/2-3/4-1-1.1/4-1.1/2-2", 230 V	15.000 kg	1	71257
SUPERTRONIC 2000 with pipe clamp, without die heads, 230 V	6.800 kg	1	71250
SUPERTRONIC 2000 BSPT R 1/2-3/4-1-1.1/4-1.1/2-2", 110 V	14.500 kg	1	71258
SUPERTRONIC 2000 NPT 1/2-3/4-1-1.1/4-1.1/2-2", 110 V	15.000 kg	1	71259
SUPERTRONIC 2000 with pipe clamp, without die heads, 110 V	6.800 kg	1	71251
SUPERTRONIC 2000 230 V, ROCASE, with ROFIX, forged pipe clamp	11.200 kg	1	1000002011

Work in confined spaces



Die heads with the tripod universal workbench



**Accessories**

**Page**

Die heads 1/4-2"	160
Dies 1/4-2"	160
Cutting fluid	161
Pipe roughing wrench	167
Ratchet pipe deburrer 1/4-2"	167



### Threading die head for SUPERTRONIC

**Precision die head up to Ø 2" for the production of precise and standardized thread connections according to EN 10226**

According to ASME B1.20.1 (NPT)

**Fully automatic production process**

Reduced production tolerances to increase the service life by up to 10%

**Threading die heads with optimized geometry**

Reduced effort of up to 10% for person and machine

**Precision threading dies**

Special viscous hard steel with long service life

**Big chamber**

Faster and easier removal of metal chips



### Application Benefits

- Threading die heads with optimized geometry to reduce the effort by up to 10% for person and machine
- Reduced manufacturing tolerance for quicker performance
- Interchangeable threading dies to increase economic efficiency
- Quick change threading die heads with secure holding for SUPER CUT, SUPERTRONIC 1250 and 2000s models



**Extra wide and exchangeable threading dies**

Highest demands and long service life

**Forcelocked octagonal universal drive with snap ring locking**

Easy and tool-free assembly with secure hold

Model	Weight	PU	No.
Threading die head BSPT R, 1/4"	0.580 kg	1	070821X
Threading die head BSPT R, 3/8"	0.555 kg	1	070822X
Threading die head BSPT R, 1/2"	0.580 kg	1	070823X
Threading die head BSPT R, 3/4"	0.610 kg	1	070824X
Threading die head BSPT R, 1"	0.815 kg	1	070825X
Threading die head BSPT R, 1.1/4"	0.905 kg	1	070826X
Threading die head BSPT R, 1.1/2"	1.665 kg	1	070842X
Threading die head BSPT R, 2"	1.535 kg	1	070843X

Model	Weight	PU	No.
Threading die head NPT, 3/8"	0.580 kg	1	070908X
Threading die head NPT, 1/2"	0.600 kg	1	070912X
Threading die head NPT, 3/4"	0.580 kg	1	070913X
Threading die head NPT, 1"	0.770 kg	1	070914X
Threading die head NPT, 1.1/4"	0.900 kg	1	070915X
Threading die head NPT, 1.1/2"	1.700 kg	1	070849X
Threading die head NPT, 2"	1.560 kg	1	070850X

### Threading dies for SUPERTRONIC BSPT R

**Precision threading dies**

In conjunction with the matching SUPER CUT die head, pipe threads can be produced according to EN 10226 (BSPT R)



Model	Weight	PU	No.
BSPT R, 1/4"	0.060 kg	1	070831X
BSPT R, 3/8"	0.060 kg	1	070832X
BSPT R, 1/2"	0.060 kg	1	070833X
BSPT R, 3/4"	0.065 kg	1	070834X
BSPT R, 1"	0.125 kg	1	070835X
BSPT R, 1.1/4"	0.135 kg	1	070836X
BSPT R, 1.1/2"	0.150 kg	1	070869X
BSPT R, 2"	0.150 kg	1	070870X

### Threading dies for SUPERTRONIC NPT

In conjunction with the matching SUPER CUT thread cutting head, pipe threads of 1/4-2" according to ASME B1.20.1 (NPT) can be produced.



Model	Weight	PU	No.
NPT, 1/4"	0.160 kg	1	070916X
NPT, 3/8"	0.060 kg	1	070917X
NPT, 1/2"	0.070 kg	1	070918X
NPT, 3/4"	0.070 kg	1	070919X
NPT, 1"	0.140 kg	1	070920X
NPT, 1.1/4"	0.140 kg	1	070921X
NPT, 1.1/2"	0.150 kg	1	070945X
NPT, 2"	0.160 kg	1	070946X

6



### ROFIX adapter

Fits small external octagonal die heads from Ø 1/4–1.1/4"

#### Application Benefits

- Easy insertion of the die head with tension ring locking



Tension ring locking

Model	Weight	PU	No.
ROFIX adapter	0.800 kg	1	71271

### RONOL

#### High-performance cutting oil

High-performance cutting fluid for producing thread connections or cutting metal. The cutting oil in various sizes can be used with manual threaders or stationary machines

#### Application Benefits

- Excellent cooling and lubricating properties
- Durability of the threading die is increased considerably
- For perfect, clean threads
- Safe for skin contact
- Also suitable as cold lubrication when cutting metal

Model	Weight	PU	No.
RONOL spray can, 600 ml	0.580 kg	12	65008
RONOL canister, 5 l	4.600 kg	1	65010
RONOL barrel, 210 l	195.500 kg	1	65011

Mineral-based cutting oil is not permitted for drinking water installations—Please check your national regulations!



### RONOL SYN

#### High-performance cutting fluid

Suitable as a coolant and lubricant for producing threads or cutting metal

#### Application Benefits

- Excellent cooling and lubricating properties
- Able to handle high pressure
- Longer life for the cutting tool
- Safe for skin contact
- Also suitable as cold lubrication when cutting metal

Model	Weight	PU	No.
RONOL SYN spray can, 600 ml	0.750 kg	12	65013
RONOL SYN canister, 5 l	5.750 kg	1	65015



## Threading and grooving

### Threading electric

#### ROPOWER 50 R

##### Portable compact threader Ø 1/4–2"

Quick and effortless production of precise and reliable pipe and bolt threads to approved standards

Use on building sites, for repairs and service, industrial use and for installation work

For threading of:

**BSPT right, EN 10226, ISO 7-1:** Ø 1/4–2"

**NPT, ASME B1.20.1:** Ø 1/4–2"

**BSPP, ISO 228-1, DIN 259:** Ø 1/2–2"

**BSW, B. S 84:** Ø 3/8–2"

**Metric, ISO 261, DIN 13:** Ø 10–24 mm

##### Application Benefits

- Quick and reliable threading, trimming, deburring, and grooving
- Effortless and comfortable transport with the light, navigable working carriage, which also serves as a workbench
- Complete pre- and post-processing of pipes
- Easy to maintain machine design
- Die head type R (automatic with integrated oil feed)
- Portable transport frame (standard)

**Original RIDGID<sup>1</sup> threading dies can optionally be used!**

##### Pre- and post-processing of pipes

###### Self-centering pipe cutter

Precise cuts

###### Internal deburrer, snap in, 3-blade

Burr-free work

###### Impact hammer chuck with maximal clamping-force

No pipe slippage

###### Self-centering rear chuck

Quick and precise alignment of the pipe

##### Easy to maintain machine design

###### Motor double insulated in accordance with VDE

Safe operation

###### Stable high torque motor

Constant power transferral

###### Off-set spindle lubrication

Easy maintenance

###### Machine slightly angled

Reduced oil consumption, oil coating in pipe interior is avoided

##### Technical Data

Working area	Ø 1/4–2"
Sound pressure level	85 dB
Sound power level (LwA)	96 dB
Power consumption	1,150 W
Rapid reverse speed	38 rpm
Vibration	2.5 m/s <sup>2</sup>
Thread type	BSPP, BSPT R, BSW, Metric, NPT



###### Geared oil pump with filter system and adjustable fluid qualities

Constant oil flow quantities

###### Large plastic shavings collection trough

Easy to clean

## ROPOWER 50 R

Set includes: ROPOWER 50 R, automatic die head 1/2–2" (No. 56052), SS dies BSPT 1/2–3/4" (No. 056370X), 1–2" (No. 056371X), safety foot switch (No. 56335), collapsible stand (No. 56051), tool

### Die head type R

Automatic die head with integrated oil feed

Long life of the die heads

Optimal lubrication and cooling of the die heads

Long life of the die heads

### Transportation frame

(Included in delivery)

### Carriage with storage space and a mount for the foot switch

Clearly arranged work

### Collapsible undercarriage

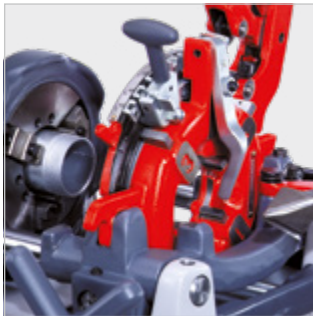
Comfortable transport

### With 2 plastic wheels

High mobility

**Fig. collapsible stand (No. 56051) included in delivery!**

Automatic die head with integrated oil supply



High mobility



Thread roughing



Cost-effective production of grooves



### Model

ROPOWER 50 R BSPT R 1/2–2", 230 V

Weight

PU

No.

88.500 kg

1

1000004212

ROPOWER 50 R BSPT R 1/2–2", 110 V

88.500 kg

1

1000004213

ROPOWER 50 R BSPP R 1/2–2", 230 V

88.500 kg

1

1000004214

ROPOWER 50 R NPT 1/2–2", 230 V

88.500 kg

1

1000004215

Folding trolley

19.200 kg

1

56051

### Accessories

### Page

Cutting fluid

161

Automatic die heads

166

Threading dies

166

NIPPLE MAX

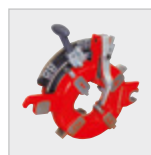
167

Pipe roughing wrench

167

ROGROOVER 1–6"

168



**SUPERTRONIC 2 SE / 3 SE / 4 SE**

**Compact threader Ø 1/4-4"**

Reliable and proven for constant professional use

- Ideal for portable and stationary threading in the workshop, on-site, for repairs and service, trade and industry, pipeline construction as well as for sanitary and heating installations
- Universal application, with or without stand, i.e. on a workbench

For threading of:

**BSPT right, EN 10226, ISO 7-1: Ø 1/4-2"**

**NPT, ASME B1.20.1: Ø 1/4-2"**

**BSPP, ISO 228-1, DIN 259: Ø 1/2-2"**

**BSW, B. S 84: Ø 3/8-2"**

**Metric, ISO 261, DIN 13: Ø 10-36 mm, Ø 10-24 mm (2 SE)**

**Can also be used in combination with a roll grooving tool!**



**Application Benefits**

- Universal die head seating (standard or automatic)
- Precise guiding of the die head
- Low-wear and precise guiding
- Fast axial alignment of the pipe
- No pipe slippage due to impact hammer chuck
- Burr-free work

6

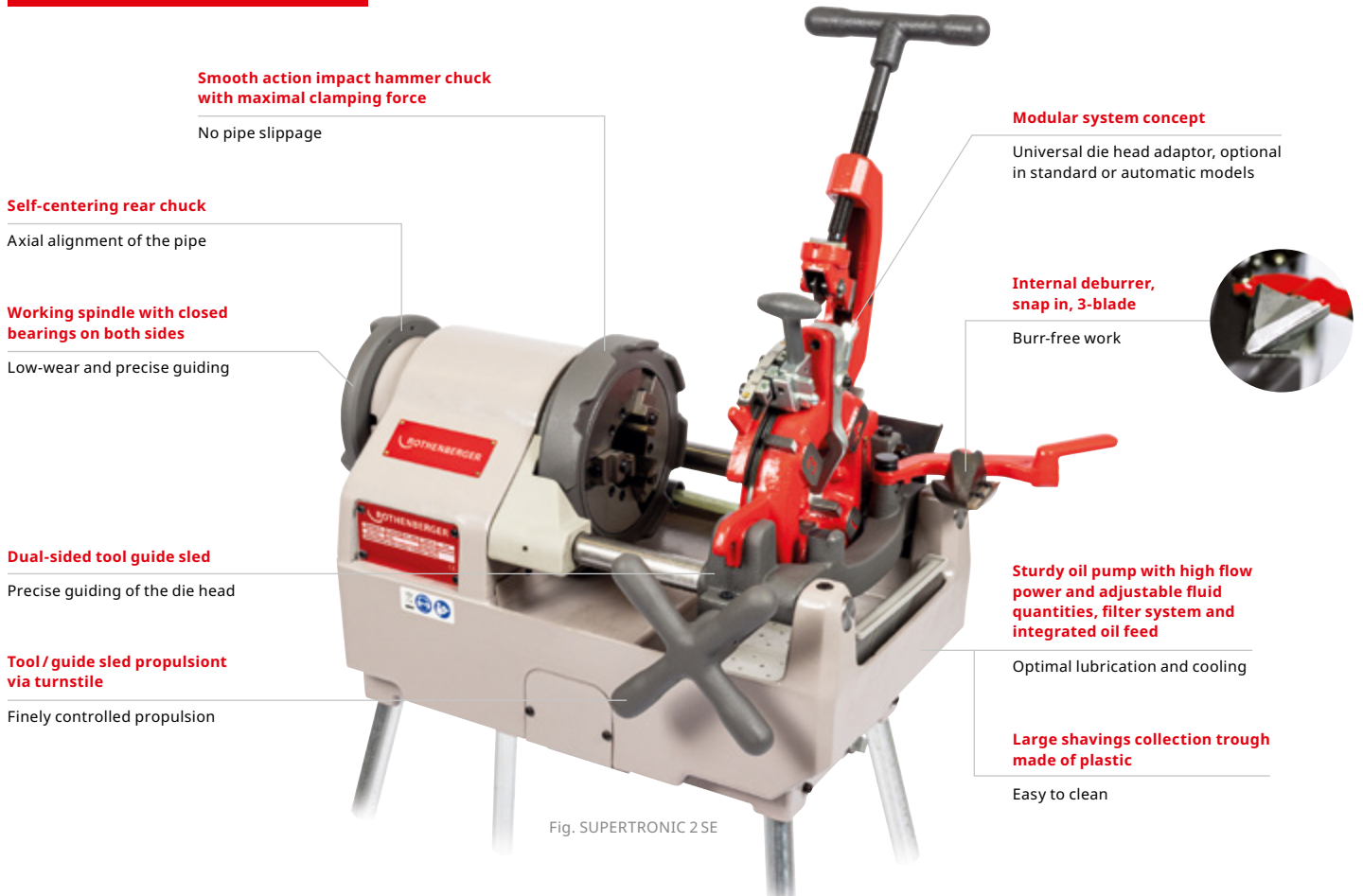


Fig. SUPERTRONIC 2 SE

Impact hammer chuck with inter-changeable clamping jaw, optimal clamping properties through flexible adjustment and broad support



Automatic die heads with quick adjustment of thread size, automatic thread length and finely adjustable thread depth without recentering



Transport frame for 3 and 4 SE (No. 57050)

### SUPERTRONIC 2 SE

#### Compact threader Ø 1/2-2"

Standard die head: 1/2-2" (No. 56156)  
Automatic die head: 1/2-2" (No. 56266)

Set includes: SUPERTRONIC 2 SE, automatic die head 1/2-2" (No. 56156) or automatic die head (No. 56266), SS threading dies 1/2-3/4" (No. 56003), 1-2" (No. 56007), safety foot switch (No. 56335), supporting legs (No. 56488), tool



Model	Weight	PU	No.
SUPERTRONIC 2 SE with standard die head, BSPT R 1/2-2", 230 V	68.000 kg	1	1500004021
SUPERTRONIC 2 SE with automatic die head, BSPT R 1/2- 2", 230 V	68.000 kg	1	1500004023
SUPERTRONIC 2 SE with automatic die head, NPT 1/2- 2", 110 V	68.000 kg	1	1500004026
SUPERTRONIC 2 SE with automatic die head, NPT 1/2-2", 230 V	68.000 kg	1	1500004028

### SUPERTRONIC 3 SE

#### Compact threader Ø 1/2-3"

Standard die head: 1/2-2" (No. 56156), 2-3" (No. 56104)  
Automatic die head: 1/2-2" (No. 56266), 2.1/2-3" (No. 56288)

Set includes: SUPERTRONIC 3 SE, standard die heads 1/2-2" (No. 56156) or automatic die heads (56266), standard die head 2-3" (No. 56104) or automatic die head 2 1/2-3" (56288), SS threading dies 1/2-3/4" (No. 56003), 1-2" (No. 56007), SS threading dies 2-3" (No. 56006), SS threading dies 2 1/2-3" (No. 56489), safety foot switch (No. 56335), supporting legs (No. 56491), tool



Model	Weight	PU	No.
SUPERTRONIC 3 SE with automatic die head, BSPT R 1/2-3", 230 V	100.000 kg	1	56255
SUPERTRONIC 3 SE with automatic die head, BSPT R 1/2-3", 230 V, CH	78.500 kg	1	056255Z
SUPERTRONIC 3 SE with standard die head, BSPT R 1/2-3", 110 V	100.000 kg	1	56253
SUPERTRONIC 3 SE with standard die head, BSPT R 1/2-3", 230 V	100.000 kg	1	56250

### SUPERTRONIC 4 SE

#### Compact threader Ø 1/2-4"

SUPERTRONIC 4 SE with automatic die head

Lever

Various adjustable speeds



Set includes: SUPERTRONIC 4 SE, BSPT automatic die head 1/2-2" (No. 56266), BSPT automatic die head 2 1/2-4" (No. 56289), SS threading dies 1/2-3/4" (No. 56003), SS threading dies 1-2" (No. 56007), SS threading dies 2 1/2-4" (No. 56294), safety foot switch (No. 56335), supporting legs (No. 56489), tool

Model	Weight	PU	No.
SUPERTRONIC 4 SE with automatic die head, BSPT R 1/2-4", 230 V	120.000 kg	1	56465
SUPERTRONIC 4 SE with automatic die head, BSPT R 1/2-4", 230 V, CH	143.000 kg	1	056465Z
SUPERTRONIC 4 SE with automatic die head, BSPT R 1/2-4", 110 V	120.000 kg	1	56475
SUPERTRONIC 4 SE with automatic die head, NPT 1/2-4", 230 V	140.500 kg	1	56466

**Precision die heads**

For machine types ROPOWER 50 R, PANDA, PISET, SUPERTRONIC 2 S, 2 SE, 3 S, 3 SE, 4 S and 4 SE

**Standard die heads**

- Time saving with a simple and quick change of the threading dies
- User-friendly with the locking positioning which eliminates complicated calibration
- Longer life of the dies with the integrated lubrication
- Guaranteed consistent cutting oil film on the pipe surface



Standard die head



Automatic die head

**Automatic die heads**

- Simple and clear operation with the quick-adjustment thread sizes
- Automatic adjustable thread length for serial production
- Flexible work: Each thread size offers individual fine adjustment of the thread depth without recentering dimension change

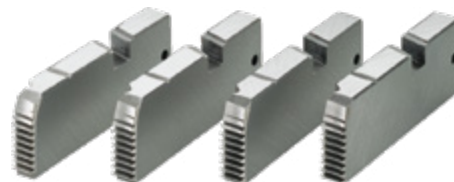
**Please note: The die heads do not include threading dies!**

**Overview die heads / threading dies**

Die heads			Threading dies			ROPOWER 50 R	SUPERTRONIC 2 SE	SUPERTRONIC 3 SE	SUPERTRONIC 4 SE
Thread type	Size	No.	Size	No. SS-steel	No. HSS-steel for stainl. steel/ INOX pipe				
<b>Automatic die heads suitable for RIDGID<sup>1</sup> threading dies</b>									
BSPT R	1/2-2"	56052	1/4-3/8"	56369	56379	●			
			1/2-3/4"	056370X	56380	●			
NPT	1/2-2"	56053	1-2"	056371X	N/A	●			
			1/4-3/8"	56372	N/A	●			
			1/2-3/4"	56373	N/A	●			
BSPP	1/2-2"	56054	1-2"	56374	N/A	●			
			1/2-3/4"	56058	N/A	●	●	●	●
			1-2"	56059	N/A	●	●	●	●
<b>Automatic die heads suitable for ROTHENBERGER threading dies</b>									
BSPT R	1/2-2"	56266	1/2-3/4"	56003	56235	●	●	●	●
			1-2"	56007	56236	●	●	●	●
	2.1/2-3"	56288	2.1/2-3"	56291	56237			●	●
	2.1/2-4"	56289	2.1/2-4"	56294	56238				●
NPT	1/2-2"	56271	1/2-3/4"	56111	56180		●	●	●
			1-2"	56112	56181		●	●	●
	2.1/2-3"	56268	2.1/2-3"	56295	56183			●	●
	2.1/2-4"	56269	2.1/2-4"	56296	N/A				●
			3.1/2-4"	N/A	56184				●
<b>ROTHENBERGER standard / manual die heads</b>									
BSPT R	1/4-3/8"	56153	1/4-3/8"	56001	56135	●	●	●	●
			1/2-2"	56156	1/2-3/4"	56003	56235	●	●
	2-3"	56104	1-2"	56007	56236	●	●	●	●
			2-3"	56006	56121			●	●
3.1/2-4"	56032	3.1/2-4"	56008	56122				●	
NPT	1/4-3/8"	56118	1/4-3/8"	56110	N/A	●	●	●	●
			1/2-2"	56156	1/2-3/4"	56111	56180	●	●
	1-2"		56112	56181	56181	●	●	●	●
BSPP	1/2-1.1/4"	56076	2.1/2-3"	56104	N/A	N/A		●	●
			1/2-3/4"	N/A	N/A	●	●	●	●
	1.1/2-3"	56077	1-1.1/4"	N/A	N/A	●	●	●	●
			1.1/2-2"	56097	N/A			●	●
			2.1/2-3"	56098	N/A			●	●

**Precision threading dies**

High material quality and precise workmanship guarantee easy cutting, clean threads and extremely long service life with outstanding chip discharge. Manufactured from high-quality tempered steel (only available in sets 4 or 5 pieces / pack)



Suitable for:

**Conical pipe threads – BSPT:**

Whitworth pipe threads: ISO 7-1, DIN EN 10226 (DIN 2999)

External pipe threads: conical, 1:16, 55° flank angle

**Conical pipe threads – NPT:**

Taper pipe threads: ASME B1.20.1

External pipe threads: conical, 1:16, 60° flank angle

**Cylindrical pipe threads – BSPP:**

Whitworth pipe threads: ISO 228-1, DIN 259

Exterior pipe threads cylindrical, 55° flank angle

**For optimal threading results, use only with original ROTHENBERGER cutting fluid or cutting oil**

### Pipe supporting column

Adjustable height, from 780 up to 1,200 mm with ball track. Maximum carrying capacity 120 kg

Pipe supporting column for all working steps during pipe processing. Pipes from R 1/2–6" can be easily and safely brought into the required working position



Model	Weight	PU	No.
Pipe supporting column 6"	5.800 kg	1	56047

### Pipe roughing wrench

Wrench made of forged steel, with hardened rolls. Consistent, thread-saving roughing of the entire area

For roughing of cylindrical or conical threads up to 2"



Model	Weight	PU	No.
Pipe roughing wrench 3/8–2"	1.150 kg	1	56500
Spare roughing rolls 3 pieces	0.300 kg	1	56501

### Safety foot switch

For all ROTHENBERGER threading machines

For use on ROPOWER 50 R and SUPERTRONIC 2–4 SE threading machines. Safety switch controllable via foot pedal Quick release of the switch by pressing the pedal. Easy unlocking of EMERGENCY STOP by separate switch



Model	Weight	PU	No.
Safety foot switch 3 step with emergency stop switch	2.500 kg	1	56335

### Internal deburrer with ratchet

Quick and clean deburring For steel pipes, with smooth-running ratchet, cutting bit made of tempered steel

For steel pipes, with smooth-running ratchet, cutting bit made of tempered steel



Model	Weight	PU	No.
Internal deburrer with ratchet, 13–60 mm (1/4–2")	2.680 kg	1	70289

### NIPPLE MAX

NIPPLE MAX Ø 1/2–2"

For the production of short pipe nipples and double nipples, by means of internal clamping. Hardened and ground clamping jaws ensure a secure hold. For all stationary tapping machines

#### Application Benefits

- Recycling pipe scraps saves money, material and time
- Automatic quick grip of the pipe piece without the need for additional tools
- Pipes are gripped from within and centred: no damage to pipe piece



Set (No. 56056) includes: nipple chuck 1/2" (No. 56060), 3/4" (No. 56061), 1" (No. 56062), 1.1/4" (No. 56063), 1.1/2" (No. 56064), steel carrying case (No. 26410)

Model	Weight	PU	No.
Nipple chuck 1/2"	0.390 kg	1	56060
Nipple chuck 3/4"	0.500 kg	1	56061
Nipple chuck 1.1/2"	0.920 kg	1	56064
NIPPLE MAX set 1/2–3/4–1–1.1/4–1.1/2"	4.360 kg	1	56056

## Threading and grooving

### Roll grooving

#### Hand roll groover 1-12"

**Manageable and compact hand roll groover for producing grooves on installed thin- and standard steel pipes up to Ø 1-12" (33-324 mm)**

Suitable for installations, sprinkler systems, larger heating units, industrial use and mining

For standard grooves on installed pipes from 1-12"

#### Application Benefits

- For pipes from Ø 1"
- Quick connection of pipes anywhere where welding is not allowed!
- Easy transportation due to small dimension
- Adjustable and finely-controlled arrester
- 1/2" ratchet for both adjustmen

#### Technical Data

Working area	Ø 1-12"
Drive	Hand

Application on tripod workbench



Fixture for stabiliser



Can also be used in combination with the SUPERTRONIC 2000 E

Model	Weight	PU	No.
Hand Roll Groover 2-6"	12.000 kg	1	1000000212
Pressure roller set 1"	2.000 kg	1	56521
Pressure roller 1.1/4-1.1/2"	2.430 kg	1	56522
Pressure roller set 2-6"	2.000 kg	1	56523
Roller set 2-6"	2.755 kg	1	887307000
Roller set 3-6"	3.100 kg	1	887308000
Roller set 8-6"	2.330 kg	1	887309000
Roller set 1"	0.590 kg	1	1000000720
Roller set 1.1/4-1.1/2"	0.620 kg	1	1000000721
Roller set 2-6"	1.000 kg	1	1000000850
Roller set 4-6"	2.480 kg	1	1000000722
Roller set 8-12"	2.700 kg	1	1000000723

#### ROGROOVER 1-6"

**Portable rolling groover for steel pipes up to Ø 6" (168 mm) for rapid rolling grooves on standard and thin-walled steel pipes**

Suitable for installations, sprinkler systems, larger heading units, industrial use and mining

**Lightweight and compact design allows for use with the threaders:**

SUPERTRONIC 2000, SUPERTRONIC 2000 E, SUPERTRONIC 4 SE, SUPERTRONIC 2 SE, SUPERTRONIC 3 SE, ROPOWER 50 R

#### Application Benefits

- Quick connection of pipes anywhere where welding isn't allowed
- Long life and little wear
- Easy to transport with the lightweight aluminium casing
- Adjustable and finely-controlled arrester for consistent groove depth
- Convenient, easy and time-saving operation



Model	Weight	PU	No.
for REX 4"	14.500 kg	1	56508
for RIDGID <sup>1</sup> 300	16.000 kg	1	56504
for ROPOWER 50 R, SUPERTRONIC 2 SE, REX 2"	14.500 kg	1	56505

Model	Weight	PU	No.
for SUPERTRONIC 2000	14.500 kg	1	56509
for SUPERTRONIC 3 SE, REX 3"	14.500 kg	1	56506
for SUPERTRONIC 4 SE	14.500 kg	1	56507



## ROGROOVER 1-12"

Electro-hydraulic rolling groover for steel pipes Ø 1-12" (33-324 mm) for rolling grooves

Suitable for installations, sprinkler systems, larger heading units, industrial use and mining



### Application Benefits

- Pressure rollers toolless adjustable due to revolver-button
- Safe working with foot switch and emergency stop switch, as well as lighting in workplace
- Reliable, powerful 1,500W motor
- Quick and fine adjustment for groovers and regulation

### Technical Data

Working area	Ø 1-12" (33-324 mm)
Pipe thickness	3-10 mm
Pressure hydraulic cylinder	40 bar
Power	1,500 W
Tank volume	150 ml
Pipe wall thickness	10 mm

#### Control panel

Power supply, light and EMERGENCY STOP

#### Circumferential steel frame

Protective bracket and carrying frame

#### Function with foot switch

Safety for users

#### Fine adjustment of the groove depth and regulation

For optimal results

#### Turret head with integrated pressure rollers

Simple, fast and tool-free

#### Adjustable pipe support stand

Ball bearing blocks for easy handling

3-way adjustment of the pressure rollers size



Drive shaft and measuring tape in the delivery



Set includes: ROGROOVER machine 1-12", pipe support stand, drive shaft, 1-1.1/2", 2-6" and 8-12" (No. 1500001709-1711), diameter measuring tape

Model	Weight	PU	No.
ROGROOVER 1-12", 110 V, USA	175.000 kg	1	1500001353
ROGROOVER 1-12", 230 V, EU	175.000 kg	1	1500001351
ROGROOVER 1-12", 230 V, SASO	175.000 kg	1	1500001352







## Soldering and welding



<b>System overview</b>	<b>172-173</b>
Cartridge brazing	174-178, 180-181
Cartridge soft soldering	178-179, 180
Cylinder brazing	182-183
Cylinder soft soldering	184-185
Electric soft soldering	186-187
Gas-welding	188-191
Three-gas welding	192-193
Accessories soldering and welding	194-203



## Cartridge brazing

	SUPER FIRE 3	SUPER FIRE 4	ROFIRE GLOBAL	ROFIRE Swivel PRO Cyclone Piezo	ROFIRE Swivel PRO Twin
					
Soft soldering	up to Ø 35 mm	up to Ø 35 mm	up to Ø 35 mm	up to Ø 42 mm	up to Ø 64 mm
Brazing	up to Ø 28 mm	up to Ø 28 mm	up to Ø 28 mm	up to Ø 18 mm	up to Ø 28 mm
Special application	Shrinking, removal of paint	Shrinking, removal of paint	○	○	○
For use with	MAPP <sup>1</sup> gas, Maxigas 400, Multigas 300	MAPP <sup>1</sup> gas, Maxigas 400, Multigas 300	MAPP <sup>1</sup> gas, Maxigas 400, Multigas 300	MAPP <sup>1</sup> gas <sup>2</sup> , Maxigas 400 <sup>2</sup> , Multigas 300 <sup>2</sup>	MAPP <sup>1</sup> gas <sup>2</sup> , Maxigas 400 <sup>2</sup> , Multigas 300 <sup>2</sup>
Page	174	176	178	178	178

## Cartridge soft soldering

## Roofing

	ROFLAME 4 PIEZO	ROFIRE 4 / ROFIRE 4 PIEZO	ROOFING Set
			
Soft soldering	up to Ø 22 mm	up to Ø 22 mm	●
Brazing	○	up to Ø 15 mm	○
Special application	○	○	Bonding of bituminous sheeting
For use with	Supergas C 200	Multigas 300	Propane, butane
Page	178	179	184

## Cartridges

	MAPP <sup>1</sup> gas	Maxigas 400	Multigas 300	Supergas C 200 TSS
				
Flame temperature	up to 2,700 °C	up to 2,200 °C	up to 1,900 °C	up to 1,800 °C
Application	Soft soldering and brazing	Soft soldering and brazing	Soft soldering	Soft soldering
Valve	7/16" EU	7/16" EU	7/16" EU	Pierceable cartridge
Page	180	181	181	181

### Brazing and soft soldering devices

	RE 17	ALLGAS 2000 set	ALLGAS 2000 PS 0.5/2 Compact	ALLGAS Mobile Pro	ROXY 400 L
Soft soldering	●	●	●	●	●
Brazing	●	●	●	●	●
Welding	0.5–14 mm	0.2–5 mm	○	○	○
Cutting	12–100 mm	○	○	○	○
For use with	Acetylene, oxygen, Maxigas 400	Acetylene, oxygen	Propane, oxygen	MAPP <sup>1</sup> gas, oxygen	Maxigas 400, oxygen
Page	192	188	189	190	191

### Cylinder brazing and soft soldering

### E-soft soldering

	AIRPROP	TURBOPROP	ROTHERM 2000
Soft soldering	up to Ø 54 mm	up to Ø 54 mm	up to Ø 54 mm
Brazing	up to Ø 22 mm	up to Ø 28 mm	○
Special application	○	○	Soft soldering without flame
For use with	Propane, butane	Propane, butane	230 V
Page	182	183	186

### Cartridges and cylinders

#### Acetylene



#### Oxygen



Application	Brazing, welding, cutting	Brazing, welding, cutting
Valve	DIN 477-1	M 10 × 1 (one-way) / G 3/4" RH
Pressure	19 bar	110 bar (one-way) / 200 bar
Page	194	194

1) MAPP is a registered trademark of the MESSER Group GmbH, Bad Soden

**SUPER FIRE 3**

**Ergonomic HEAVY DUTY brazing tool**

For brazing and soldering up to Ø28 mm as well as for other applications, e.g. dissolving paint or shrinking hoses

**Hard soldering:** up to Ø28 mm  
(with flame reflector in wind-protected environment)  
**Soft soldering:** up to Ø35 mm



**Application Benefits**

- Fast heating, less consumption!
- Long service life
- “Twist ‘n’ Load” system (5 different burners)—change burners with one handle
- Exact flame adjustment
- Up to 2.5 hours brazing with one cartridge
- Comfort for longer working (locking knob)
- Reliable piezo ignition (up to 30,000 ignitions)
- Double safety, as No. gas escape without locking the torch (piezo ignition)

**Technical Data**

Coupling	7/16" EU
Handle	Aluminium, bolted
Burner	Brass / stainless steel

7

**Elaborately manufactured brass / stainless steel design**  
Long service life

**Fast “Twist ‘n’ Load” system**  
Exchange of the burners with one movement (5 different burners available)

**Burners with swirl flame**  
Rapid heat-up, less consumption!

**Fine regulating valve**  
Precise flame adjustment

**Ergonomically designed handle**  
Robust and optimum handling made of high-quality aluminium

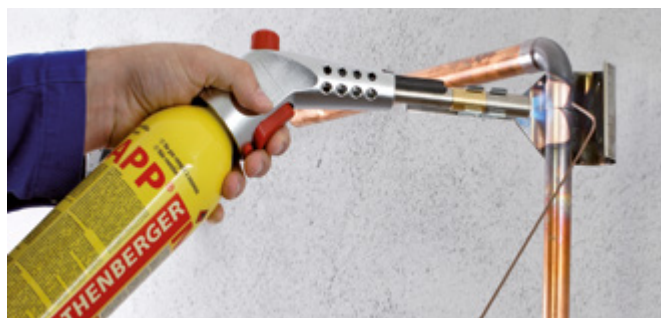
**Only ignites if burner has been securely locked**  
Dual safety

**High-performance piezo**  
Reliable (up to 30,000 ignitions)

**Locking button**  
Continual use with only one hand

**ROTHENBERGER MAPP<sup>1</sup> gas**  
Up to 2.5 hours of brazing with one cartridge

Brazing in gas installation



High flame temperature based on cyclone swirl



Brazing in refrigeration / air-conditioning technology



**Pin-point burner (460 °C)**

For fine soldering; precise and stable flame



No. 35455

**Standard burner (700 °C)**

For soft soldering and other jobs with lower heat application; precise, powerful and stable flame



No. 35456

**Cyclone burner (950 °C)**

For hard and soft soldering with an efficient swirl flame (allows pipe to heat up evenly)



No. 35457

**Hot air burner (400 °C)**

For the removal of paint and for shrinking work up to approx. 80 mm diameter; wind-stable, powerful current of hot airpowerful, wind-stable soft flame



No. 35458

**Shrinking burner (720 °C)**

For shrinking up to Ø300mm and for heating; powerful, wind-stable soft flame



No. 35459

**SUPER FIRE 3 HOT BOX****Application Benefits**

- The ideal service kit
- For repairs, heating installations and refrigeration / air-conditioning technology

**RO  
CASE****Hot**

5-part set (No. 100002369) includes: handle (No. 35445), cyclone burner (No. 35457), pin-point burner (No. 35455), flame reflector (No. 31043), universal torch support (No. 35461), 2 × MAPP<sup>1</sup> gas A cartridges (No. 035521-A), ROCASE 4414 (No. 100001945)

Model	Weight	PU	No.
SUPER FIRE 3 HOT BOX EU incl. MAPP <sup>1</sup> gas A	4.270 kg	1	100002369
SUPER FIRE 3 HOT BOX EU incl. MAPP <sup>1</sup> gas B	4.165 kg	1	100002370
SUPER FIRE 3 HOT BOX EU incl. MAPP <sup>1</sup> gas C	4.165 kg	1	100002371

**SUPER FIRE 3**

Set (No. 35436) includes: handle (No. 35445), cyclone burner (No. 35457)

**When placing your order, remember to order the universal torch support (No. 35461) for stationary soldering, too!**

Model	Weight	PU	No.
SUPER FIRE 3 with cyclone burner 7/16" EU	0.550 kg	1	35436
SUPER FIRE 3 with cyclone burner 1" US	0.700 kg	1	35431
SUPER FIRE safety adaptor 7/16" to 1"	0.102 kg	1	035648X



No. 035648X



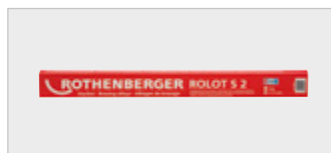
No. 35436



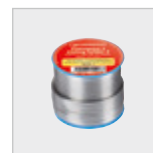
No. 31050



No. 854186



No. 40212



No. 45252



No. 45268



No. 45220

Accessories	Page	No.
Welding blanket	197	31050
Internal brushes for copper pipes	197	854186
Solder	198	40212

Accessories	Page	No.
Fittings solder	199	45252
ROVLIES cleaning pads	196	45268
ROSOL soldering paste	199	45220

1) MAPP is a registered trademark of the MESSER Group GmbH, Bad Soden

**SUPER FIRE 4**

**Ergonomic professional soldering tool**

For hard soldering up to Ø28 mm and soft soldering up to Ø35 mm as well as for other applications, such as dissolving paint or shrinking hoses

**Hard soldering:** up to Ø28 mm  
(with flame reflector in wind-protected environment)

**Soft soldering:** up to Ø35 mm



**Application Benefits**

- Fast heating of the material, less consumption!
- “Twist ‘n’ Load” system (5 different burners)—Replacing the burner with just one handle.
- Precise flame adjustment
- Improved locking mechanism for one-handed use
- Reliable piezo ignition (up to 30,000 ignitions)
- Double safety, No. gas leakage without locking the burner (piezo ignition)
- Longer handle for even more stable positioning on the gas cartridge

**Technical Data**

Coupling	7/16" EU
Handle	Plastic, rubberized
Burner	Brass / stainless steel

7

**Elaborately manufactured brass / stainless steel design**

Long service life

- ✓ Safe
- ✓ Fast
- ✓ Reliable

**Dual safety**

Only ignites if burner has been securely locked

**High-performance piezo**

Reliable (up to 30,000 ignitions)

**Locking button**

Continual use with only one hand

**“Twist ‘n’ Load”**

**Fast “Twist ‘n’ Load” system**

Exchange of the burner with one movement (5 different burner available)

**Optimized fine regulating valve**

Precise flame adjustment, faster opening and closing

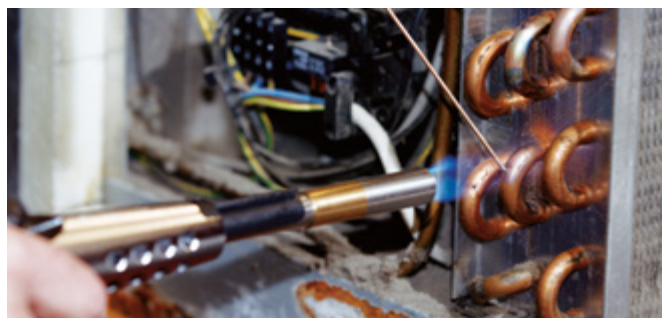


**Ergonomically designed handle**

Robust, light and slipfree through rubberized surface



Brazing in refrigeration / air-conditioning technology



High flame temperature based on cyclone swirl



Brazing in refrigeration / air-conditioning technology





**Pin-point burner (460 °C)**

For fine soldering; precise and stable flame



No. 35455

**Standard burner (700 °C)**

For soft soldering and other jobs with lower heat application; precise, powerful and stable flame



No. 35456

**Cyclone burner (950 °C)**

For hard and soft soldering with an efficient swirl flame (allows pipe to heat up evenly)



No. 35457

**Hot air burner (400 °C)**

For the removal of paint and for shrinking work up to approx. 80 mm diameter; wind-stable, powerful current of hot airpowerful, wind-stable soft flame



No. 35458

**Shrinking burner (720 °C)**

For shrinking up to Ø 300mm and for heating; powerful, wind-stable soft flame



No. 35459

**SUPER FIRE 4 HOT BOX****Application Benefits**

- The ideal service kit
- For repairs, heating installations and refrigeration / air-conditioning technology



5-part set (No. 1000002364) includes: handle (No. 1500001354), cyclone burner (No. 35457), pin-point burner (No. 35455), flame reflector (No. 31043), universal torch support (No. 35461), 2 x MAPP<sup>1</sup> gas A cartridges (No. 035521-A), ROCASE 4414 (No. 1000001945)

Model	Weight	PU	No.
SUPER FIRE 4 HOT BOX EU incl. MAPP <sup>1</sup> gas A	4.055 kg	1	1000002364
SUPER FIRE 4 HOT BOX EU incl. MAPP <sup>1</sup> gas B	3.965 kg	1	1000002366
SUPER FIRE 4 HOT BOX EU incl. MAPP <sup>1</sup> gas C	4.095 kg	1	1000002368
SUPER FIRE 4 HOT BOX US incl. MAPP <sup>1</sup> gas US	4.055 kg	1	1000001630

**SUPER FIRE 4**

Set (No. 1500001355) includes:  
handle (No. 1500001354), cyclone burner (No. 35457)

**When placing your order, remember to order the universal torch support (No. 35461) for stationary soldering, too!**

Model	Weight	PU	No.
SUPER FIRE 4 with cyclone burner 7/16" EU	0.400 kg	1	1500001355
SUPER FIRE 4 with cyclone burner 1" US	0.370 kg	1	1500001503
SUPER FIRE safety adaptor 7/16" to 1"	0.102 kg	1	035648X



No. 035648X



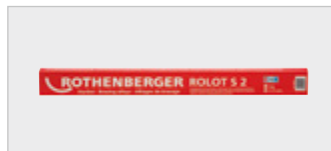
No. 1500001355



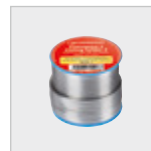
No. 31050



No. 854186



No. 40212



No. 45252



No. 45268



No. 45220

Accessories	Page	No.
Welding blanket	197	31050
Internal brushes for copper pipes	197	854186
Solder	198	40212

Accessories	Page	No.
Fittings solder	199	45252
ROVLIES cleaning pads	196	45268
ROVLIES soldering paste	199	45220

1) MAPP is a registered trademark of the MESSER Group GmbH, Bad Soden

### ROFIRE GLOBAL

**Ergonomic torch for brazing and soft soldering applications**

**Brazing:** up to Ø 28mm  
(with flame reflector in wind-protected environment)  
**Soft soldering:** up to Ø 35 mm

#### Application Benefits

- Powerful cyclone torch for efficient brazing up to Ø 28 mm
- Ideal with MAPP<sup>1</sup> gas: up to 2.5 hours of brazing with only one cartridge
- Piezo ignition for comfortable and safe work
- Protection against triggering of the Piezo ignition when falling down

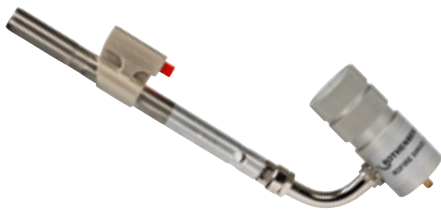
Model	Weight	PU	No.
ROFIRE GLOBAL, 7/16" EU	0.250 kg	1	1500002869



### ROFIRE SWIVEL PRO Cyclone Piezo

**Cyclone burner with piezo ignition**

**Coupling:** 1" US  
**Brazing:** up to Ø 18 mm  
**Soft soldering:** up to Ø 42 mm

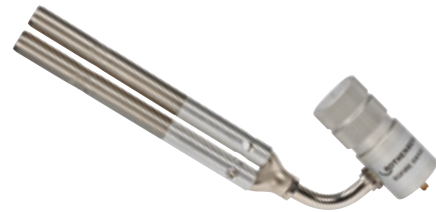


Model	Weight	PU	No.
ROFIRE SWIVEL PRO cyclone piezo	0.400 kg	1	35016

### ROFIRE SWIVEL PRO Twin

**Twin cyclone burner**

**Coupling:** 1" US  
**Brazing:** up to Ø 28 mm  
**Soft soldering:** up to Ø 64 mm



Model	Weight	PU	No.
ROFIRE SWIVEL PRO Twin	0.400 kg	1	35012

### ROFLAME 4 PIEZO

**Ergonomic soft soldering torch for a safe and comfortable usage**

**Soft soldering:** up to Ø 22 mm

#### Application Benefits

- Integrated preheating function for optimum flame pattern, even in overhead applications (360°)
- Robust metal housing for C 200 cartridges
- 2-component design made of rubberized plastic for excellent ergonomics and handling
- Reliable piezo ignition (up to 30,000 ignitions)
- Precise adjustment of the burner flame

#### Technical Data

Coupling	Pierceable connection (C 200 cartridges)
Handle	Plastic, rubberized
Burner	Brass / stainless steel
Housing	Inox burner, 2-component rubber-plastic handle, metal cartridge housing



Model	Weight	PU	No.
ROFLAME 4 PIEZO without gas cartridge	0.630 kg	1	1000002358

## ROFIRE 4

Ergonomic soft soldering torches for safe and comfortable use

**Hard soldering:** up to Ø 15 mm  
**Soft soldering:** up to Ø 22 mm

### Application Benefits

- Integrated preheating function for optimum flame pattern even in overhead applications (360°)
- Precise adjustment of the burner flame

### Technical Data

Coupling	7/16" EU
Handle	Plastic
Burner	Brass / stainless steel

Model	Weight	PU	No.
ROFIRE 4 without gas cartridge	0.300 kg	1	1500002921
ROFIRE 4 incl. Multigas 300	0.750 kg	1	1000002359



## ROFIRE 4 PIEZO

Ergonomic soft soldering torches for safe and comfortable use

**Hard soldering:** up to Ø 15 mm  
**Soft soldering:** up to Ø 22 mm

### Application Benefits

- Integrated preheating function for optimum flame pattern, even for overhead applications (360°)
- 2-component design made of rubberized plastic for excellent ergonomics and handling
- Reliable piezo ignition (up to 30,000 ignitions)
- Precise adjustment of the burner flame

### Technical Data

Coupling	7/16" EU
Handle	Plastic, rubberized
Burner	Brass / stainless steel



#### Stainless steel burner with preheat function

Applicable in any position, even overhead (360°)

Integrated pre-heat function for a stable flame, even when turning it upside down (360°)



Soft soldering in drinking water and heating installation



#### Protection collar

Extended design for safe and stable positioning on gas cartridges

#### Fine adjustment valve

Precise flame adjustment

#### High-performance piezo

Reliable up to 30,000 firings

#### 2-component handle

Rubberized plastic for easy, ergonomic handling and grip



Model	Weight	PU	No.
ROFIRE 4 PIEZO without gas cartridge	0.300 kg	1	1500002922
ROFIRE 4 PIEZO incl. Multigas 300	0.750 kg	1	1000002360

**MAPP<sup>1</sup> gas**

**High-performance gas for brazing and soldering**

Flame temperatures up to 2,700 °C and 35 % faster than propane



**Application Benefits**

- Excellent heat transfer, faster than propane, even in winter below 0 °C.
- Increased safety and stability thanks to solid valve and protective collar
- Provides high flame output in any position, even overhead (360°)
- Easy handling
- Guarantees constant high burning performance
- Longer operating time

**100% propylene**

Excellent flame performance, even in overhead applications. Higher heat transfer than propane

**Steel cylinder**

High stability, especially for high pressure gases

**7/16" EU brass valve**

Patented design for high pressure gases

**Protection collar**

Stabilizes the burner on the bottle and protects in case of accidental drop



Protective collar stabilizes the torch and protects against accidental drops



SUPER FIRE 3 HOT BOX (see page 175)

SUPER FIRE 4 HOT BOX (see page 177)

**Packaging profile**

Model	MAPP <sup>1</sup> gas
No.	035521-A
EAN code	4004625400180
Product size (mm) (W × H)	70 × 270
Contents (ml)	800
Weight (g)	400
Unit per box	12
Boxes per layer / pallet	10
Layer per pallet	3
Units per pallet	360
Number of pallets per truckload	60
Units per truckload	21,600
Pallet weight (kg)	324
Pallet size (mm) (L × W × H)	800 × 1,200 × 1,000
Carton size (mm) (L × W × H)	290 × 310 × 240

Model	Weight	PU	No.
MAPP <sup>1</sup> gas 7/16" EU, version A Languages: DE, GB, FR, ES, IT, PT	0.900 kg	12	035521-A
MAPP <sup>1</sup> gas 7/16" EU, version B Languages: DK, NL, SE, FI, FR, RUS	0.900 kg	12	035521-B
MAPP <sup>1</sup> gas 7/16" EU, version C Languages: CZ, PL, HU, BG, TR, RO	0.900 kg	12	035521-C

## Maxigas 400

High-performance welding, cutting and brazing gas for flame temperatures up to 2,200 °C. Gas cartridge with 7/16" EU coupling thread.



### Packaging profile

Model	Maxigas 400
No.	035570-A / -B
EAN code	4004625355701 (A)
Product size (mm) (W × H)	65 × 260
Contents (ml)	600
Weight (g)	352
Unit per box	24
Boxes per layer / pallet	9
Layer per pallet	3
Units per pallet	648
Number of pallets per truckload	60
Units per truckload	38,880
Pallet weight (kg)	195
Pallet size (mm) (L × W × H)	800 × 1,200 × 1,000
Carton size (mm) (L × W × H)	405 × 272 × 264

## Multigas 300

Propane / butane gas mixture for flame temperatures up to 1,900 °C. Gas cartridge with 7/16" EU connection thread.



### Packaging profile

Model	Multigas 300
No.	035510-A / -B
EAN code	4004625355107 (A)
Product size (mm) (W × H)	65 × 260
Contents (ml)	600
Weight (g)	338
Unit per box	24
Boxes per layer / pallet	9
Layer per pallet	3
Units per pallet	648
Number of pallets per truckload	60
Units per truckload	38,880
Pallet weight (kg)	191
Pallet size (mm) (L × W × H)	800 × 1,200 × 1,000
Carton size (mm) (L × W × H)	405 × 272 × 264

## Supergas C 200 TSS

Butane piercing cartridge with propane content also for working at low temperatures. Manufactured according to EN 417:2012, with integrated Top Safe System (TSS). This system largely retains escaping gas when disconnecting from the device.



### Packaging profile

Model	C 200 TSS
No.	035901-A / -B
EAN code	4004625390627 (A)
Product size (mm) (W × H)	90 × 95
Contents (ml)	330
Weight (g)	190
Unit per box	36
Boxes per layer / pallet	9
Layer per pallet	3
Units per pallet	972
Number of pallets per truckload	60
Units per truckload	58,320
Pallet weight (kg)	350
Pallet size (mm) (L × W × H)	800 × 1,200 × 1,180
Carton size (mm) (L × W × H)	360 × 275 × 280

**AIRPROP brazing set**

**Propane high-performance torch for brazing up to Ø22 mm and soft soldering up to Ø54 mm**

For brazing and soft soldering of copper and steel pipes up to 2,000°C without oxygen, as well as warming up, shrinking and flame cleaning



**Application Benefits**

- Bundled, concentrated and hot flame due to built-in gas turbine in brazing burner
- Absolutely gas-tight due to optimized valve technology
- Gas-saving operation due to smooth-running economy valve
- Quick replacement of burners without tools

**Technical Data**

Self-induced air	Turbine and combustion chamber
Torch	Surface treated, chromed brass
Hose coupling	G 3/8" LH

**Built-in gas turbine in brazing torch**

Bundled, concentrated and hot flame

**Smooth-turning economy valve**

Gas-saving operation

**Optimized valve technology**

Absolutely gas tight

**Shut-off valve**

Prevents uncontrolled gas leakage

**Absolutely gas-tight connections thanks to dual O-ring technology**

Fast burner exchange without tools

7



No. 31092

Fig. similar

Sets include: safety handle with push-in coupling (No. 21121116), brazing burner with push-in nipple Ø 14 mm (No. 221131416) / Ø 16 mm (No. 221131616) / Ø 19 mm (No. 221131916), propane hose, 2.5 m with 3/8" LH coupling (No. 32201), safety igniter (No. 32077), replacement flints (No. 32088), open-ended spanner (No. 32073), steel case (No. 31005)

Model	Weight	PU	No.
AIRPROP brazing set without propane regulator	2.800 kg	1	31092
AIRPROP brazing set with propane regulator (No. 32081)	3.100 kg	1	31091



**Brazing burner with threaded coupling**

Ø mm	Length mm	g/h 2 bar	kWh-kcal-BTU	Weight	No.
14	140	125	1.60-1,375-5,465	0.095 kg	30913
16	145	180	2.30-3,300-7,885	0.100 kg	30914
19	170	300	3.84-3,300-13,115	0.130 kg	30915
22	171	400	5.12-4,440-26,195	0.145 kg	30916

**Brazing burner with push-in nipple coupling**

Ø mm	Length mm	g/h 2 bar	kWh-kcal-BTU	Weight	No.
14	140	125	1.60-1,375-5,465	0.095 kg	221131416
16	145	180	2.30-3,300-7,885	0.100 kg	221131616
19	170	300	3.84-3,300-13,115	0.130 kg	221131916
22	171	400	5.12-4,440-26,195	0.145 kg	221132216

**TURBOPROP brazing set**

**Propane high-performance torch for brazing up to Ø28 mm and soft soldering Ø54 mm**

For brazing and soft soldering of copper and steel pipes up to 2,200 °C without oxygen, as well as for warming up, shrinking and flame cleaning

**Application Benefits**

- Bundled, concentrated and hot flame due to built-in gas turbine in brazing burner
- Absolutely gas-tight due to optimized valve technology
- Gas-saving operation due to smooth-running economy valve
- Quick replacement of burners without tools

**Technical Data**

Self-induced air	Turbine and combustion chamber
Torch	Surface treated, chromed brass
Hose coupling	G 3/8" LH

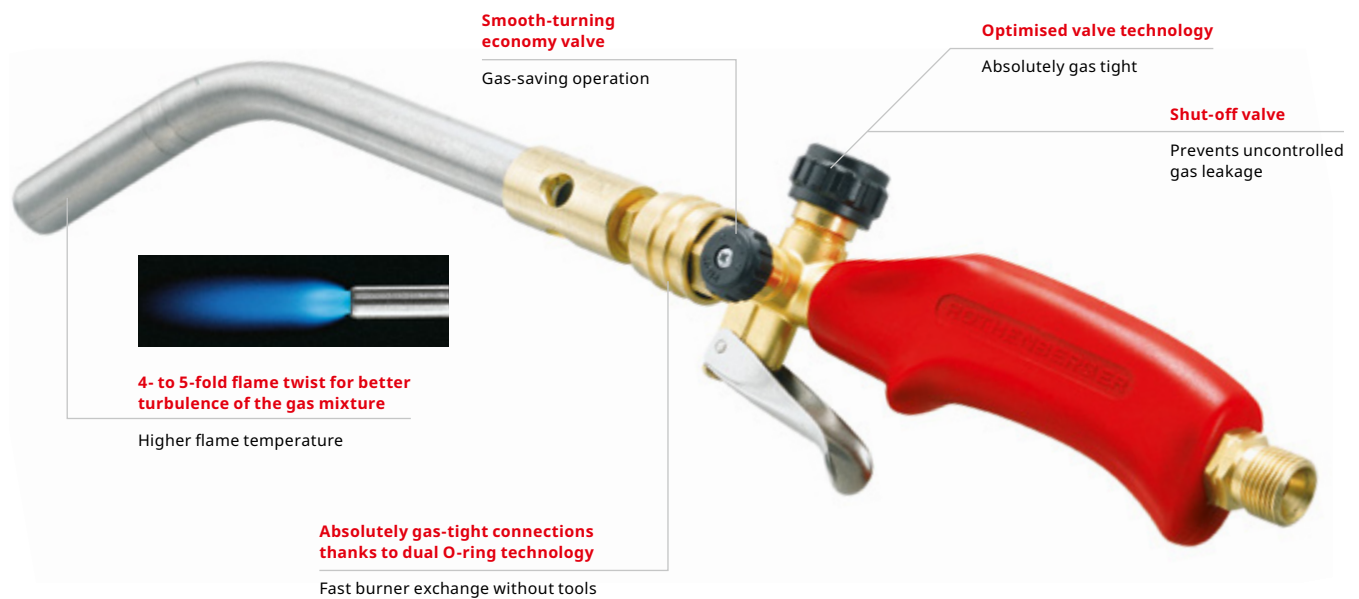
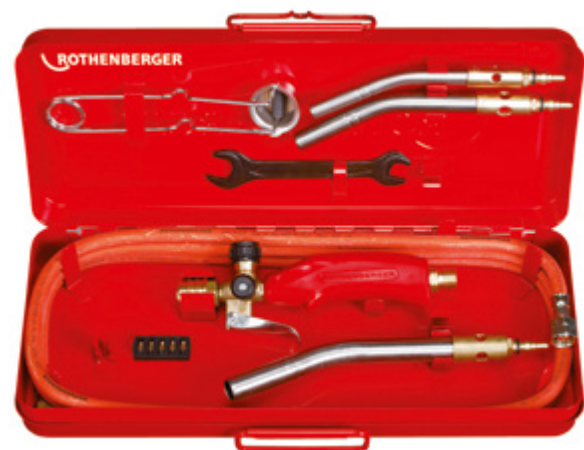


Fig. TURBOPROP burner with push-in nipple



No. 31090

Fig. similar

Sets include: safety handle with push-in coupling (No. 211121116), brazing burner with push-in nipple Ø 12 mm (No. 31032) / Ø 15 mm (No. 221031500) / Ø 18 mm (No. 221031800), propane hose, 2.5 m with 3/8" LH coupling (No. 32201), safety igniter (No. 32077), replacement flints (No. 32088), open-ended spanner (No. 32073), steel case (No. 31005)

Model	Weight	PU	No.
TURBOPROP brazing set without propane regulator	2.800 kg	1	31090
TURBOPROP brazing set with propane regulator (No. 32081E)	3.100 kg	1	31094

**Brazing burner with push-in nipple coupling**

Ø mm	Length mm	g/h 2 bar	kWh-kcal-BTU	Weight	No.
12	175	110	1.41-1,210-4,815	0.090 kg	31032
15	195	180	2.30-1,980-7,855	0.110 kg	221031500
18	230	240	3.07-2,640-10,485	0.160 kg	221031800

**ROOFING set**

**Propane heating torch with Ø 63 mm high performance torch head**

Ideal for roofing and asphaltting work and for bonding bitumen membranes, large-scale weed flaming, thawing, insulating, shrinking, drying and heating.

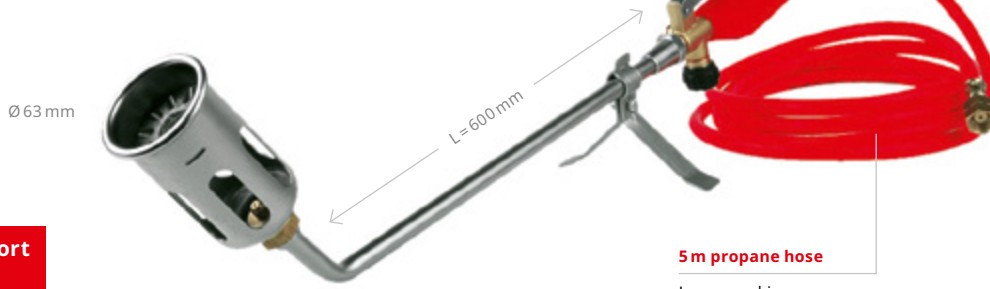
**Application Benefits**

- Large working range due to 5 m propane hose
- Efficient working even in adverse weather conditions due to flame stabilizer
- High-performance burner with long service life due to chrome plating and edge reinforcement



**Technical Data**

600 mm burner tube  
Burner support



**Burner support included!**

Ideal for roofing and asphalt work



600 mm burner tube with support and 5 m propane hose



5-part set (No. 30954) includes: propane handle (No. 215111216), 63 mm high-performance torch (No. 223216300), 600 mm torch pipe (No. 236010000), 5 m propane hose (No. 32203), torch support (No. 252010000)

Model	Weight	PU	No.
ROOFING set	1.920 kg	1	30954
ROOFING set (as No. 30954, with pressure regulator No. 30925)	2.300 kg	1	30957

**Extensions**

Special tube, chrome-plated, bent 40°, inlet M 14 × 1, outlet M 20 × 1



Model	Weight	PU	No.
Extension 100 mm	0.090 kg	1	231010000
Extension 200 mm	0.120 kg	1	232010000
Extension 350 mm	0.190 kg	1	233510000
Extension 600 mm	0.290 kg	1	236010000

**Surface-heating burner heads**

Highly efficient torch heads with flame stabilizer, made of chrome-plated special steel, edge-reinforced. For heating, shrinking, insulating, hardening, general repair work and much more. Threaded connection M 20 × 1. The closed heating torch heads are insensitive to wind.



Ø mm	Length mm	g/h 2 bar	kWh-kcal-BTU	Weight	No.
<b>open</b>					
51	112	3,800	48.60-41,800-165,970	0.270 kg	223090716
63	138	6,700	85.70-73,700-292,670	0.440 kg	223090916
<b>closed</b>					
45	102	2,500	32.00-27,500-109,280	0.240 kg	223214500
51	112	3,800	48.60-41,800-165,970	0.270 kg	223215100
57	126	5,500	70.35-60,500-240,257	0.350 kg	223215700
63	138	6,700	85.70-73,700-292,670	0.440 kg	223216300



## Safety propane handles

With economy, regulating and shut-off valve, hose connection G 3/8" LH



No. 211121116



No. 211121116

Model	No.
Safety propane handle with M 14 × 1 coupling	211121116
Safety propane handle with push-in coupling	211121116
Repair kit with regulating valve, complete	30102

## Propane regulators

Brass, for 0.5 kg, 5 kg and 11 kg bottles

Inlet	Outlet	Working pressure bar	Performance kg/h	No.
W 21.8 × 1/14" LH	G 3/8" LH	0.5–4.0	8	32081
G 3/8" LH	G 3/8" LH	0–6	8	242206000
W 21.8 × 1/14" LH	G 3/8" LH	4	8	30925



No. 242206000



No. 30925



No. 32081

## Propane hoses

Top quality, with strong insert, resistant and flexible, fully assembled with grommets and union nuts, up to 20 bar (2 MPa).

Length mm	Inlet	Outlet	Standard	Interior-Ø mm Wall thickness	No.
2	G 3/8" LH	M 10 × 1 LH	ISO 3821	4.0 × 3.5	30927
2.5	G 3/8" LH	G 3/8" LH	ISO 3821	4.0 × 3.5	32201
5	G 3/8" LH	G 3/8" LH	ISO 3821	4.0 × 3.5	33310
10	G 3/8" LH	G 3/8" LH	EN 1327	5.0 × 3.5	32223



No. 30927



No. 32223

## Refilling adaptor

For filling 0.425 kg small propane cylinders from 3 kg, 5 kg or 11 kg propane gas cylinders

Inlet	Outlet	Weight	PU	No.
W 21.8 × 1/14" LH	G 3/8" LH	0.160 kg	1	32207



## Propane steel cylinder

With cylinder valve, according to TRG with TÜV test, protective collar and hook included in delivery

Model	Outlet	Content	Weight	PU	No.
Small cylinder 0.425 kg, with foot	G 3/8" LH	Empty	2.750 kg	1	33079
Protective collar for No. 33079			0.276 kg	1	35636



#### ROTHERM 2000

##### Electric soft soldering unit up to $\varnothing 54 \text{ mm} / 2.1/8''$

For simple, safe and time-saving soft soldering without flame. Particularly suitable for repair and conversion work in rooms or apartments at risk of fire and in the renovation of old buildings.

**Soft soldering of copper tubes up to:**  $\varnothing 6\text{--}54 \text{ mm}$ ,  $1/4\text{--}2.1/8''$

##### Application Benefits

- Soldering without open flame
- Large working radius also for working below ceilings
- Comfortable transport and working
- High power, short soldering times
- Automatic shutdown in case of overload
- No overheating of the handle
- No need to purchase and transport gas cylinders
- Complies with transport regulations
- Connection to any 230 V socket, 2 m connection cable
- Fast device amortization
- Mains control lamp (red) and working control lamp (green), device fuse accessible from the outside



##### Technical Data

Power	2,000 W
Soldergun cable	4 m
Dimensions (L x W x H)	260 x 190 x 200 mm

**Soldering without open flame!**



**2,000 W**

High performance,  
short soldering times

**Thermal overload protection**

Automatic shutdown of the device

**Large-dimensioned stainless steel cooling fins on both tong legs**

No overheating of the handle shells

**Small design**

Comfortable transport  
and work

**Highly flexible, extra long 4 m solder gun cable**

Large working radius, also for  
work below ceilings

**Soldering without open flame**

No fire hazard due to burning of wall  
or floor coverings or plastic drains

### ROTHERM 2000 set

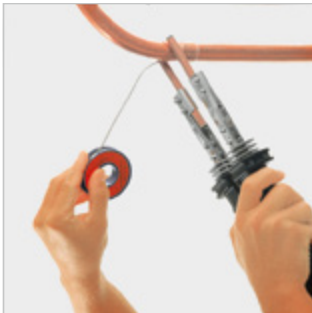
Set (No. 36702) includes: ROTHERM 2000 soft soldering unit, 230V (No. 36700), ROSOL 3 fittings soldering paste (No. 45225), fitting solder 3 (No. 45255), ROVLIES (No. 45268), internal brushes 12 mm (No. 854181)/ 15 mm (No. 854183)/ 18 mm (No. 854185)/ 22 mm (No. 854186)/ 28 mm (No. 854187), steel case (No. 1300007335)

Particularly suitable for repair and modification work in surroundings or rooms with a fire hazard, as well as in building refurbishment!

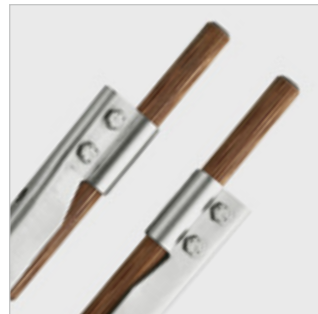


Fig. similar

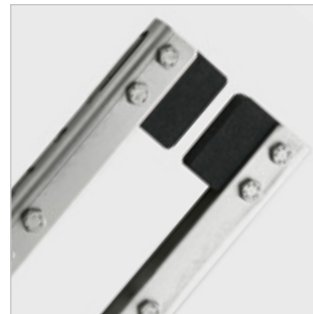
Warming up of the soldering joint without open flame



Rod electrodes for working near to the wall or between parallel running pipes with narrow gaps (can be ordered separately)



Flat electrode



Simple replacement of electrodes and electrode holders



No. 36721



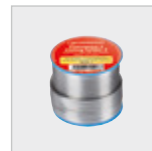
No. 36720



No. 45225



No. 45220



No. 45252



No. 854186

#### Accessories

	No.
Flat electrode (pair)	36721
Flat electrode with holder (pair)	36711
Rod electrodes (pair)	36720
Rod electrodes with holder (pair)	36710

#### Accessories

	Page	No.
ROVLIES cleaning pads	196	45268
ROSOL soldering paste	199	45220
Fittings solders	199	45252
Internal brushes for copper pipe	197	854186

**ALLGAS 2000 set**

**Universal oxyacetylene soldering and welding torch**

The ideal soldering and welding torch for plumbers, heating engineers, refrigeration/air conditioning technicians, the automotive trade and for tinsmiths.

**Soldering range:** Up to 2.5 mm material thickness

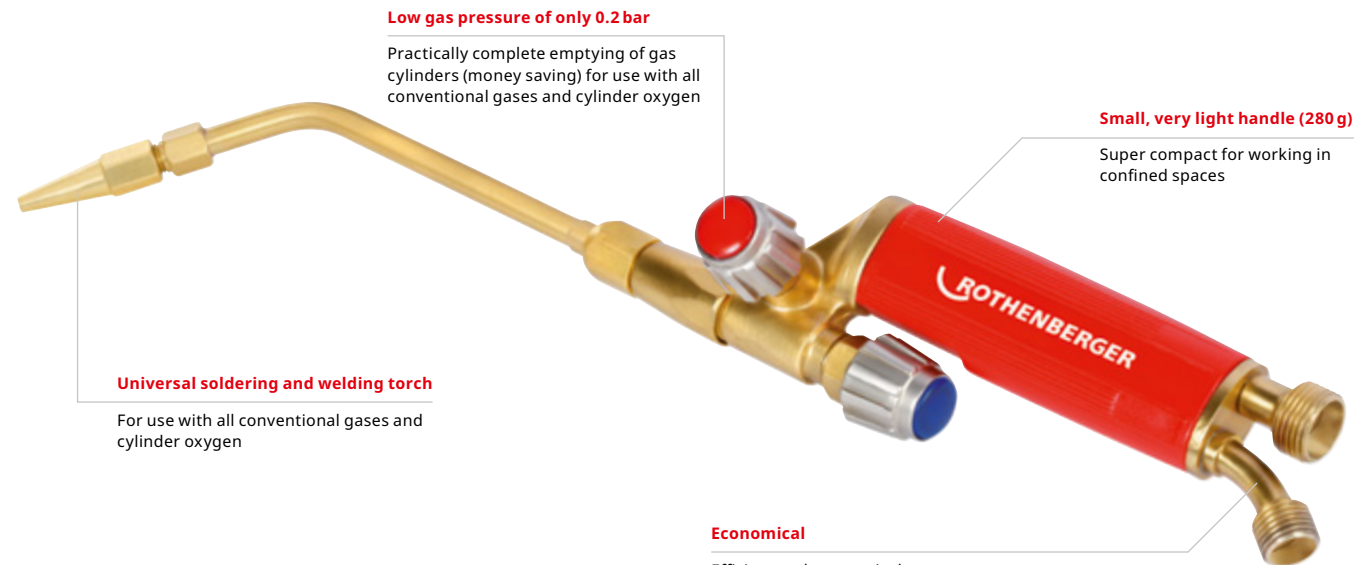
**Welding range:** 0.2–5 mm

**Applicable with fuel gases:** Acetylene with oxygen, propane with oxygen, natural gas with oxygen, town gas with oxygen



**Application Benefits**

- Universally applicable with all common fuel gases and cylinder oxygen
- Almost residue-free emptying of gas cylinders (cost-saving)
- Handy and compact for working in hard-to-reach places
- Economical and cost-effective for professional use



**Economical**

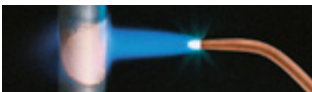
Efficient and economical professional use

7

Flexible pipe welding attachments



Safe and quick flame positioning



Dispersion burners for warming up



**17-part set (No. 35300) includes:** handle (No. 35303), mixing burners with union nut (No. 35304), welding tips 0.2–1.0 mm (No. 35305) / 1.0–2.0 mm (No. 35306) / 2.0–3.0 mm (No. 35307) / 3.0–4.0 mm (No. 35308) / 4.0–5.0 mm (No. 35309), flexible welding tips size 1 (No. 35313) / size 2 (No. 35314), coupling / union nut size 14 (No. 35315), dispersion burners (No. 35311), 2.5 m dual-hose package (No. 35221), open-ended spanner size 14 × 19 mm (No. 32073), welding tip holder / spanner (No. 35312), safety igniter (No. 32077), replacement flints (No. 32088), steel case (No. 35319)

Model	Coupling oxygen	Coupling fuel gas	Weight	No.
ALLGAS 2000 set (acetylene)			3.100 kg	35300
ALLGAS 2000 handle	G 1/4" RH	G 3/8" LH	0.280 kg	35303
Mixing burners with union nut			0.040 kg	35304

Model	Welding range mm	Weight	No.
Welding tip size 1	0.2–1	0.010 kg	35305
Welding tip size 2	1.0–2.0	0.010 kg	35306
Welding tip size 3	2.0–3.0	0.010 kg	35307
Welding tip size 4	3.0–4.0	0.010 kg	35308
Welding tip size 5	4.0–5.0	0.010 kg	35309
Welding tip holder, can be used as a spanner		0.020 kg	35312
Flexible welding tip size 1	2.0–3.0	0.040 kg	35313
Flexible welding tip size 2	4.0–5.0	0.040 kg	35314
Coupling / union nut size 14		0.010 kg	35315



ALLGAS 2000 set

Fig. similar

## ALLGAS 2000 PS 0,5 / 2 Compact

### Portable brazing equipment with carrying frame

For brazing iron, steel, sheet steel, pipes and non-ferrous metals

#### Application Benefits

- Secure transport in closed supporting frame
- Portable, light brazing equipment
- Ideal for mobile building-site and repair use
- Small propane cylinders can be refilled

#### Technical Data

Gas	Propane and oxygen
Flame temperature	3,100 °C
Working temperature	1,300 °C

**With safety devices  
to prevent flashbacks**

24-part set (No. 35655) includes: ALLGAS 2000 handle (No. 35303), propane hose, 2.5 m (No. 32201), oxygen hose, 2.5 m (No. 35210), propane regulator adjustable 0–6 bar (No. 242206000), oxygen pressure reducer 10 bar (No. 35634), mixing burners with union nut (No. 35304), welding tips 0.2–1.0 mm (No. 35305) / 1.0–2.0 mm (No. 35306) / 2.0–3.0 mm (No. 35307) / 3.0–4.0 mm (No. 35308) / 4.0–5.0 mm (No. 35309), flexible welding tips size 1 (No. 35313) / size 2 (No. 35314), dispersion burners (No. 35311), welding tip holder / spanner (No. 35312), multi-size spanner (No. 35738), safety igniter (No. 32077), replacement flints (No. 32088), nylon safety goggles (No. 540620), small propane cylinder 0.425 kg, empty (No. 33079), steel oxygen cylinder 2.0 l, full (No. 35635), oxygen safety device (No. 1000000633), carrying frame (No. 35629)

Model	Weight	PU	No.
ALLGAS 2000 PS 0,5 / 2 Compact set	21.400 kg	1	35655
Carrying frame without accessories	10.300 kg	1	35629



The bottle colors shown are without obligation! Fig. similar

Carrying comfort



## ALLGAS 2000 welding tips

For brazing iron, steel, sheet steel, pipes and non-ferrous metals

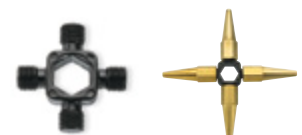
Model	Welding range mm	Weight	No.
Welding tip size 1	0.2–1	0.010 kg	35305
Welding tip size 2	1.0–2.0	0.010 kg	35306
Welding tip size 3	2.0–3.0	0.010 kg	35307
Welding tip size 4	3.0–4.0	0.010 kg	35308
Welding tip size 5	4.0–5.0	0.010 kg	35309
Welding tip holder, can be used as a spanner		0.020 kg	35312



Welding tips, thread M8 x 1



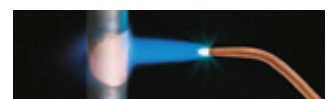
No. 35309



No. 35312

## Flexible pipe welding attachments

Model	Welding range mm	Weight	No.
Flexible welding tip size 1	2.0–3.0	0.040 kg	35313
Flexible welding tip size 2	4.0–5.0	0.040 kg	35314
Coupling / union nut size 14		0.010 kg	35315



**ALLGAS Mobile Pro**

**Mobile brazing machine with safety devices**

For brazing copper, brass, aluminum, iron, steel, sheet metal, pipes and non-ferrous metals



**Application Benefits**

- Mobile soldering set with a weight of less than 6 kg incl. cartridges
- High quality safety devices for both cartridges to prevent flame flashback
- MAPP<sup>1</sup> gas pressure regulator with adjustment range 0-2 bar for constant, low consumption and efficient flame adjustment

**Technical Data**

Gas	MAPP <sup>1</sup> gas with oxygen
Flame temperature	over 3,100 °C
Working temperature	1,300 °C

Accessories included in the set



**High quality safety devices**

Reliable prevention of gas returns and flashbacks

**Pressure regulator 0-2 bar**

Constant, low consumption and efficient flame adjustment

**Total weight <6 kg**

High mobility in construction site use

**High quality rubber hoses**

20 bar, certified according to DIN EN ISO 3821, length: 2.5 m

**MAPP<sup>1</sup> and oxygen**

Flame temperature above 3,100 °C

**Welding and brazing torches**

Including 5 interchangeable burners and a bendable welding attachment for a material thickness up to 5 mm



Fig. similar

Model	Weight	PU	No.
ALLGAS Mobile Pro 1" US without cartridges	3.860 kg	1	1000000529
ALLGAS Mobile Pro 1" US with cartridges	5.950 kg	1	1000000743
ALLGAS Mobile Pro 7/16" EU without cartridges	3.860 kg	1	1000000642
ALLGAS Mobile Pro 7/16" EU with cartridges	5.700 kg	1	1000000558

Model	Weight	PU	No.
MAPP <sup>1</sup> gas 1" US, 750 ml	0.900 kg	12	35698
MAPP <sup>1</sup> gas 7/16" EU, 800 ml	0.900 kg	12	035521-A
Oxygen, disposable, 950 ml, 110 bar	1.330 kg	12	35750
Pressure regulator 1" US for MAPP <sup>1</sup> /LPG	0.380 kg	1	1000000620
Pressure regulator M10 x 1 for oxygen	0.350 kg	1	1000000629

1) MAPP is a registered trademark of the MESSER Group GmbH, Bad Soden

**ALLGAS 2000 PS 0,5 / 2 Basic****Portable fitter's brazing equipment**

For brazing iron, steel, sheet steel, pipes and non-ferrous metals

**Application Benefits**

- Compact and handy construction for mobile building-site and repair use
- Job compatible combination, assembled and ready to use

**18-part set (No. 35651) includes:** ALLGAS 2000 handle (No. 35303), propane hose, 2.5 m (No. 32201), oxygen hose, 2.5 m (No. 35210), propane regulator adjustable 0–6 bar (No. 242206000), oxygen pressure reducer 10 bar (No. 35634), mixing burners with union nut (No. 35304), welding tips 0.2–1.0 mm (No. 35305) / 1.0–2.0 mm (No. 35306) / 2.0–3.0 mm (No. 35307) / 3.0–4.0 mm (No. 35308) / 4.0–5.0 mm (No. 35309), welding tip holder / spanner (No. 35312) multi-size spanner (No. 35738), safety igniter (No. 32077), replacement flints (No. 32088), steel oxygen cylinder 2.0 l, filled (No. 35635), propane cylinder 0.5 kg, empty (No. 33079), ALLGAS stand (No. 35628)

Model	Weight	PU	No.
ALLGAS 2000 PS 0,5 / 2 Basic set	14.400 kg	1	35651

Space saving storage in service vehicles!



The bottle colors shown are without obligation! Fig. similar

**ROXY 400 L Set****Standard gas-welding equipment for flame temperatures up to 3,100 °C**

For brazing copper, brass, aluminum, iron, steel, sheet metal, pipes and non-ferrous metals

**19-part set (No. 035780X) includes:** handle with fine regulating valve (No. 35580), Maxigas 400 (No. 035570-A), oxygen cylinder 2.0 l (No. 35635), fine regulating valve (No. 263003700), oxygen pressure 10 bar (No. 35634), hose set, 3 m without handle (No. 35785), oxygen blowback protection (No. 100000633), gas blowback protection (No. 35691), mixing burners with union nut (No. 35587), high-performance tips 1.5 mm (No. 263005600) / 2.0 mm (No. 263005400), micro-tips 0.3 mm (No. 35712) / 0.5 mm (No. 35696) / 0.7 mm (No. 35713), micro-tip adaptor (No. 35585), welding goggles A5 (No. 35621), safety igniter (No. 32077), multi-size spanner (No. 35738), carrying frame (No. 35727)

Model	Weight	PU	No.
ROXY 400 L complete	10.800 kg	1	035780X
ROXY 400 L without oxygen	6.000 kg	1	35782
Welding-handle M14 × 1	0.120 kg	1	35580
Dual hose set 3 m	0.950 kg	1	35785
Micro-tip adaptor	0.010 kg	1	35585
Micro-tip 0.3 mm	0.010 kg	1	35712
Micro-tip 0.4 mm	0.010 kg	1	35695
Micro-tip 0.5 mm	0.020 kg	1	35696
Micro-tip 0.6 mm	0.020 kg	1	35697
Micro-tip 0.7 mm	0.020 kg	1	35713
High-performance tip 0.7 mm	0.060 kg	1	263005800
High-performance tip 1.5 mm	0.040 kg	1	263005600
High-performance tip 2.0 mm	0.040 kg	1	263005400

Space saving storage in service vehicles!



The bottle colors shown are without obligation! Fig. similar

Three-gas welding

**RE 17 three-gas system AMS 5/5**

**Assembly, welding, cutting and brazing machine**  
**Welding range: 0.5–14 mm, cutting range 12–50 mm**

**Including gas cylinders and dual-telescoping transport trolley!**

27-part set (No. 35400) includes: handle with coupling nut (No. 35324), welding attachments 0.5–1.0 mm (No. 35325) / 1.0–2.0 mm (No. 35326) / 2.0–4.0 mm (No. 35327) / 4.0–6.0 mm (No. 35328) / 6.0–9.0 mm (No. 35329) / 9.0–14.0 mm (No. 35334), wing-lever cutting attachment (No. 35338), cutting tips 12–25 mm (No. 35341) / 25–50 mm (No. 35344), heating burners 12–100 mm (No. 35339), dual hoses A/O, 5 m (No. 35222), acetylene pressure reducer 1.5 bar (No. 35794), oxygen pressure reducer 10 bar (No. 35634), 2 × red (No. 511428) / 2 × blue protective rubber caps (No. 511427), 10 piece burners cleaning set (No. 510105), torch spanner (No. 510106), safety igniter (No. 32077), replacement flints (No. 32088), acetylene cylinder 5 l, filled (No. 35178), oxygen cylinder 5 l, filled (No. 35188), Maxigas 400 (No. 035570-A), gas regulating valve Maxigas (No. 1300003161), hose adaptor Maxigas (No. 35491), steel case (No. 35800), dual-telescoping transport trolley (No. 35354)

Model	Weight	PU	No.
RE 17 three-gas system AMS 5/5	50.000 kg	1	35400



The bottle colors shown are without obligation! Fig. similar

**RE 17 three-gas system AMS 5/10**

**Assembly, welding, cutting and brazing system**  
**Welding range: 0.5–14 mm, Cutting range: 12–50 mm**

**Including dual-telescoping transport trolley!**

24-part set (No. 35403) includes: handle with coupling nut (No. 35324), welding attachments 0.5–1.0 mm (No. 35325) / 1.0–2.0 mm (No. 35326) / 2.0–4.0 mm (No. 35327) / 4.0–6.0 mm (No. 35328) / 6.0–9.0 mm (No. 35329) / 9.0–14.0 mm (No. 35334), wing-lever cutting attachment (No. 35338), cutting tips 12–25 mm (No. 35341) / 25–50 mm (No. 35344), heating burners 12–100 mm (No. 35339), dual hoses A/O, 5 m (No. 35222), acetylene pressure reducer 1.5 bar (No. 35794), oxygen pressure reducer 10 bar (No. 35634), 2 × red (No. 511428) / 2 × blue protective rubber caps (No. 511427), 10 piece burners cleaning set (No. 510105), torch spanner (No. 510106), safety igniter (No. 32077), replacement flints (No. 32088), gas regulating valve Maxigas (No. 1300003161), hose adaptor Maxigas (No. 35491), steel case (No. 35800), dual-telescoping transport trolley (No. 35354)

Model	Weight	PU	No.
RE 17 three-gas system AMS 5 and 10	23.000 kg	1	35403



The bottle colors shown are without obligation! Fig. similar

**RE 17 three-gas system AMS 10/10**

**Assembly, welding, cutting and brazing system**  
**Welding range: 0.5–14 mm, Cutting range: 12–50 mm**

**Including gas cylinders and dual-telescoping transport trolley!**

27-part set (No. 35401) includes: handle with coupling nut (No. 35324), welding attachments 0.5–1.0 mm (No. 35325) / 1.0–2.0 mm (No. 35326) / 2.0–4.0 mm (No. 35327) / 4.0–6.0 mm (No. 35328) / 6.0–9.0 mm (No. 35329) / 9.0–14.0 mm (No. 35334), wing-lever cutting attachment (No. 35338), cutting tips 12–25 mm (No. 35341) / 25–50 mm (No. 35344), heating burners 12–100 mm (No. 35339), dual hoses A/O, 5 m (No. 35222), acetylene pressure reducer 1.5 bar (No. 35794), oxygen pressure reducer 10 bar (No. 35634), 2 × red (No. 511428) / 2 × blue protective rubber caps (No. 511427), 10 piece burners cleaning set (No. 510105), torch spanner (No. 510106), safety igniter (No. 32077), replacement flints (No. 32088), acetylene cylinder 10 l, filled (No. 35179), oxygen cylinder 10 l, filled (No. 35189), Maxigas 400 (No. 035570-A), gas regulating valve Maxigas (No. 1300003161), hose adaptor Maxigas (No. 35491), steel case (No. 35800), dual-telescoping transport trolley (No. 35354)

Model	Weight	PU	No.
RE 17 three-gas system AMS 10/10	66.000 kg	1	35401



The bottle colors shown are without obligation! Fig. similar



**RE 17 UNIVERSAL pipe welding set**

**Assembly, welding, cutting and brazing machine**  
**Welding range: 0.5–14 mm, cutting range 12–100 mm**



Set (No. 35479) includes: handle with coupling nut (No. 35324), welding attachments 2.0–4.0 mm (No. 35327) / 4.0–6.0 mm (No. 35328) / 6.0–9.0 mm (No. 35329), flexible pipe-welding tips 2.0–4.0 mm (No. 35347) / 4.0–6.0 mm (No. 35348), wing-lever cutting attachment (No. 35338), cutting tip 12–25 mm (No. 35341), heating burners 12–100 mm (No. 35339), nozzle cleaning set, 10 piece (No. 510105), torch spanner (No. 510106), safety igniter (No. 32077), replacement flints (No. 32088), steel case (No. 35800)

Model	Weight	No.
RE 17 pipe welding set	4.300 kg	35479
RE 17 pipe welding set as in set No. 35479, but also including with welding attachments 0.5–1.0 mm / 1–2 mm, cutting tip 12–25 mm / 25–50 mm	4.800 kg	35480
Steel case RE 17, empty	1.700 kg	35800
RE 17 handle with burner coupling nut, Oxygen G 1/4" RH, gas G 3/8" LH	0.470 kg	35324



No. 35480 Fig. similar



No. 35324

**RE 17 welding attachments**

Model	Welding range mm	Weight	PU	No.
Welding attachment	0.5–1	0.140 kg	1	35325
Welding attachment	1–2	0.150 kg	1	35326
Welding attachment	2–4	0.170 kg	1	35327
Welding attachment	4–6	0.190 kg	1	35328
Welding attachment	6–9	0.220 kg	1	35329
Welding attachment	9–14	0.260 kg	1	35334

**RE 17 welding attachments, bendable**

Welding attachment, complete			Welding attachment, bendable		
Welding range mm	Weight	No.	Welding range mm	Weight	No.
			1–2	0.040 kg	35475
2–4	0.140 kg	35347	2–4	0.040 kg	35476
4–6	0.150 kg	35348	4–6	0.050 kg	35477

Welding attachment, bendable



Welding attachment, complete

**RE 17 wing-lever cutting attachment**

Model	Weight	PU	No.
Cutting attachment without tips	0.820 kg	1	35338

**RE 17 cutting tips and heating burners**

Model	Welding range mm	Weight	PU	No.
Cutting tip	12–25	0.010 kg	1	35341
Cutting tip	25–50	0.020 kg	1	35344
Cutting tip	50–100	0.020 kg	1	35345
Heating burners	12–100	0.050 kg	1	35339



No. 35338

No. 35341  
No. 35344  
No. 35345

No. 35339

### Oxy-acetylene hoses

Top quality in accordance with ISO 3821 (former EN 559), with strong inlay, durable and flexible, rubber, mounted with sleeves and nuts



### Oxygen hoses

Length m	Inlet	Outlet	Internal Ø × Wall thickness	Weight	PU	No.
2.5	G 1/4" RH	G 1/4" RH	4×3.5	0.500 kg	1	35210
5.0	G 1/4" RH	G 1/4" RH	4×3.5	1.100 kg	1	33311

### Dual hoses A / O

Length m	Inlet Outlet Oxygen	Inlet Outlet Acetylene	Internal Ø × Wall thickness	Weight	PU	No.
2.5	G 1/4" RH	G 3/8" LH	6.3×3.5	0.900 kg	1	35221
5.0	G 1/4" RH	G 3/8" LH	6.3×3.5	2.000 kg	1	35222
10	G 1/4" RH	G 3/8" LH	6.3×3.5	3.800 kg	1	35223



7

### Lightweight steel cylinders, filled

With cylinder valve and cap (5l and 10l), TÜV tested in accordance with TRGI

Model	Contents	Filling pressure bar	Height mm	Ø mm	PU	No.
Oxygen	950 ml	110	340	70	12	35750
Oxygen	2l	200	420	110	1	35635
Oxygen	5l	200	595	145	1	35188
Oxygen	10l	200	980	145	1	35189
Acetylene	5l	18	595	145	1	35178
Acetylene	10l	18	980	145	1	35179



Protective bracket included in delivery for steel cylinders without cap

The bottle colors shown are without obligation! Fig. similar

### Cylinder transport trolley

Portable and mobile, for 5 and 10l acetylene / oxygen cylinders, 5 kg and 12 kg propane cylinders can be used with conversion kit (special accessory). Coupling for disposable Maxigas 400 cartridges, dual-telescoping for different cylinder heights, brackets for ALLGAS and RE 17 steel cases

Model	Weight	PU	No.
Transport trolley for 5-10l acetylene / oxygen cylinders	8.700 kg	1	35354



## Cylinder pressure reducer

Robust pressed brass construction according to EN ISO 2503 with large pressure gauge according to ISO 5171, with shut-off and safety valves. Acetylene cylinder pressure reducer with bow coupling according to DIN 477-1

Cylinder contents bar	Working pressure bar	Inlet	Outlet	Weight	PU	No.
Oxygen 0-200	0-10	G 3/4" RH	G 1/4" RH	1.400 kg	1	35634
Acetylene 0-40	0-1.5	Bow	G 3/8" LH	1.600 kg	1	35794



## Blowback prevention

Safety devices (flashback arrestors) according to EN 730-1 and ISO 5175-1, type tested, with flame arrestor (FA) and non-return valve (NV). No. 540360 and No. 540365 are additionally equipped with a temperature-sensitive cut-off valve (TV) and filter

Model	max. working pressure	Coupling	No.
Handle-mounted, oxygen	25 bar	G 1/4" RH	540360
Handle-mounted, acetylene 1.5 bar (ACE)	5 bar (propane/CNG)	G 3/8" LH	540365
Reducer-mounted, oxygen	25 bar	G 1/4" RH	1000000633
Handle, oxygen	20 bar	G 1/4" RH	1000000764
Handle, fuel gas	1.5 bar (ACE)	G 3/8" LH	1000000762
	4 bar (propane/CNG)		



## Protective rubber cap

With slot, open

Model	Color	Weight	PU	No.
For oxygen pressure reducer	Blue	0.050 kg	1	511428
For acetylene pressure reducer	Red	0.050 kg	1	511427



## Oxygen refilling bend

Suitable for all 0.67l, 2l, 3l, 5l, 10l, 20l and 50l bottles up to 200 bar

Model	Weight	PU	No.
max. 200 bar, cylinder coupling G 3/4"	0.355 kg	1	35199



## Safety igniter

Powerful spark, wear-free hard alloy friction surface

Model	Weight	PU	No.
Safety igniter	0.060 kg	1	32077
Replacement flints, 5 pcs.	0.015 kg	1	32088



## Soldering and welding

### Accessories soldering and welding

#### Magnet welding mirror

Model	Weight	PU	No.
With flexible metal tube/ball joint	0.450 kg	1	540855
Spare steel mirror	0.050 kg	1	540851



No. 540855

#### Burners cleaner

Model	Weight	PU	No.
In folding case, 11 pcs.	0.020 kg	1	510105



#### Torch spanner

Model	Weight	PU	No.
With 10 wrench sizes	0.210 kg	1	510106



#### Welding goggles EN 166

With thermal glasses as per EN 169

Model	Glass	Weight	No.
Nylon safety goggles	A 4	0.060 kg	540620
	A 5	0.060 kg	540621
	clear, non-splintering	0.060 kg	540622
Replacement glass (pair)	A 4	0.030 kg	540625
	A 5	0.010 kg	540626
Screw-ring safety goggles	clear, non-splintering	0.030 kg	540627
	A 4	0.090 kg	540640
	A 5	0.090 kg	540641
Replacement glass (Ø 50 mm)	A 4	0.030 kg	540675



No. 540620

No. 540622



No. 540640

#### ROVLIES cleaning pads

Groove-free cleaning of solder joints on copper tubes due to metal-free fleece

##### Application Benefits

- Reduction of corrosion damage
- No metallic abrasion, can be used wet and dry
- Removes oxide layers, corrosion, surface dirt, greasy and oily residues
- Solvent resistant and elastic

Model	Weight	PU	No.
ROVLIES, 10 pcs.	0.080 kg	1	45268
ROVLIES counter display, 36 pcs.	2.180 kg	1	045268D



## Internal brushes for copper pipe

For simple and effective pretreatment of the solder joint with sturdy plastic handle

Ø mm	Weight	PU	No.	Ø mm	Weight	PU	No.
8	0.060 kg	1	854179	18	0.120 kg	1	854185
12	0.080 kg	1	854181	22	0.140 kg	1	854186
14	0.090 kg	1	854182	28	0.140 kg	1	854187
15	0.100 kg	1	854183	35	0.160 kg	1	854188
16	0.120 kg	1	854184				



Fig. similar

## Hand wire brushes

Model	Rows	Weight	PU	No.
Standard steel	3 rows	0.130 kg	1	561351



## Welding blanket

Flame retardant and temperature resistant up to 840 °C

### Application Benefits

- Continuous temperature resistant up to 700 °C under direct flame exposure and liquid slag
- Good formability, long service life, asbestos-free and harmless to health
- Edges chained



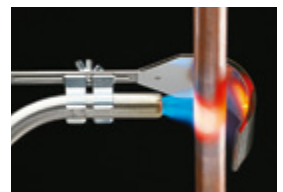
Thickness: 2.8 mm  
Weight: 1,600 g/m<sup>2</sup>

Model	L×W×H	Weight	PU	No.
Welding blanket	330×500×3 mm	0.300 kg	1	31050

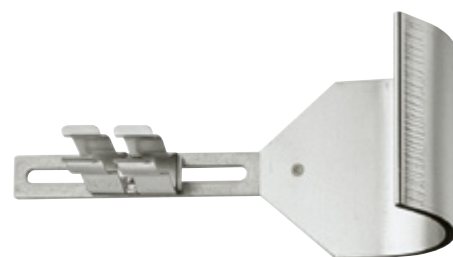
## Flame reflectors

### Application Benefits

- Made of high quality stainless steel
- Protection of surrounding combustible materials
- Optimal heat utilization, saves time and energy



Model	Width mm	Adaptor Ø mm	Weight	PU	No.
65/15	65	8-15	0.100 kg	1	31042
65/22	65	15-22	0.100 kg	1	31043



Fitting soft solder according to EN standard

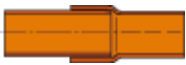
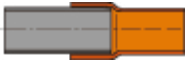




Standard type according to EN 9453	Solder composition in weight %	Melting range °C	Suitable for soft soldering in the plumbing industry			Recommended heat source
			Pipe material	Fittings material	Recommended flux according to EN 9454-1	
S-Sn97Cu3	Sn 97, Cu 3	230–250	Copper	Copper, gunmetal, brass	Part 1 – 3.1.1, 3.1.2, 2.1.2 or ROSOL 3	Cartridge burner, heat resistant soldering unit, propane/induced-air burner, acetylene/induced-air burner, larger pipe diameters above 28 mm with propane/oxygen burner with dispersion burners
S-Sn97Ag3	Sn 96.7, Ag 3.3	221–240	Copper	Copper, gunmetal, brass	Part 1 – 3.1.1, 3.1.2, 2.1.2 or ROSOL 1 S	

Standard solder according to EN ISO standard

Standard type according to ISO 17672	Solder composition in weight %	Melting range °C	Working temperature °C	Suitable for installation technology brazing				Recommended heat source
				Pipe material	Fittings material	Flux	Recommended flux according to EN 1045	
CuP 179	Cu 94/P 6	710–890	760	Copper	Copper, Gunmetal, Brass	without flux with flux	FH 10 or LP 5	Cartridge torch with MAPP <sup>1</sup> gas, Propane/induced-air torch, Acetylene/induced-air torch, Larger pipe diameters above 28 mm with propane/oxygen torch with dispersion burners
CuP 279	Ag 2/ Cu 91,8/ P 6,2	645–825	740	Copper	Copper, Gunmetal, Brass	without flux with flux	FH 10 or LP 5	
CuP 281	Ag 5/ Cu 89/P 6	645–815	710	Copper	Copper, Gunmetal, Brass	without flux with flux	FH 10 or LP 5	
CuP 284	Ag 15/ Cu 80/P 5	645–800	700	Copper	Copper, Gunmetal, Brass	without flux with flux	FH 10 or LP 5	
Ag 134	Ag 34/ Cu 36/ Zn 27,5/ Sn 2,5	630–730	710	Steel, Copper	Steel, Copper, Gunmetal, Brass	with flux (U = sheathed from 22 mm pipe-Ø)	FH 10 or LP 5	
Ag 145	Ag 34/ Cu 36/ Zn 27,5/ Sn 2,5	640–680	670	Steel, Copper	Steel, Copper, Gunmetal, Brass	with flux (U = sheathed from 22 mm pipe-Ø)	FH 10 or LP 5	

7

Soldered joints

Material	Required hard solder	Melting range °C	Working temperature °C	Standard
<b>Copper-Copper</b> 	S 34 Cu / S 34 Cu U S 94 S 2 S 5 S 15	630–730 710–890 645–825 645–815 645–800	710 760 740 710 700	DIN EN ISO 17672 (former DIN EN 1044)
<b>Copper-Carbon steel</b> 	S 34 Cu / S 34 Cu U S 45 Cu / S 45 Cu U	630–730 640–680	710 670	DIN EN ISO 17672 (former DIN EN 1044)
<b>Copper-Brass</b> 	S 94 S 2 S 5 S 15	710–890 645–825 645–815 645–800	760 740 710 700	DIN EN ISO 17672 (former DIN EN 1044)
<b>Brass-Carbon steel</b> 	S 34 Cu / S 34 Cu U S 45 Cu / S 45 Cu U	600–690 595–630	600–690 595–630	DIN EN ISO 17672 (former DIN EN 1044)
<b>Brass-Brass</b> 	S 94 S 2 S 5 S 15	710–890 645–825 645–815 645–800	760 740 710 700	DIN EN ISO 17672 (former DIN EN 1044)
<b>Carbon steel-Carbon steel</b> 	S 34 Cu / S 34 Cu U S 45 Cu / S 45 Cu U	630–730 640–680	710 670	DIN EN ISO 17672 (former DIN EN 1044)

## Fittings solders

Quality soft solders according to EN 9453 for joining copper pipes to copper, gunmetal and brass fittings for hot and cold-water plumbing in accordance with DVGW worksheet GW 2 without flux, for use with corresponding ROSOL fittings solder paste.



No. 45252



No. 45257

### Fitting solder 1 S

Quality soft solder S-Sn97Ag3, melting range 221–240 °C, for use with ROSOL 1 S fittings solder paste

Solder wire Ø	Description	Weight	PU	No.
2 mm	250 g coil	0.270 kg	1	45252
3 mm	250 g coil	0.270 kg	1	45250

### Fitting solder 3

Quality soft solder, S-Sn97Cu3, melting range 230–250 °C, for use with ROSOL 3 fittings solder paste

Solder wire Ø	Description	Weight	PU	No.
2 mm	250 g coil	0.270 kg	1	45257
3 mm	250 g coil	0.270 kg	1	45255

## ROSOL soldering paste

Quality soft soldering flux according to EN ISO 9453 and EN 29454-1, 3.1.1.C, with DVGW test mark Reg.-No. DV-0101AT2247, for joining copper pipes to copper, gunmetal and brass fittings for hot and cold-water plumbing in accordance with DVGW worksheet GW 7, metal content 60 % by weight, flux residues are 100 % water soluble.



### ROSOL 1 S

#### Fittings solder paste

Quality soft soldering flux, metal content: S-Sn97Ag3, only for use with fitting solder 1 S

Model	Weight	PU	No.
ROSOL 1 S in plastic bottle 250 g	0.270 kg	1	45220



### ROSOL 3

#### Fittings solder paste

Quality soft soldering flux, metal content: S-Sn97Cu3, only for use with fittings solder 3

Model	Weight	PU	No.
ROSOL 3 in plastic bottle 250 g	0.270 kg	1	45225

## Hard solder rings

Made of high-quality, silver-phosphorous safety brazing alloy, guaranteed according to EN ISO 17672, CuP 279

### Application Benefits

- Ideal for capillary gap soldering in copper pipe installation in sanitary and heating technology
- Exactly matched to the inside diameter of the brazed pipes and fittings according to EN 1254
- Complete through-soldering of the soldered joints
- Particularly economical work due to precisely metered solder quantity
- No preparation and rework at the soldering point

### Technical Data

Alloy (weight %)	Ag 1.5–2.5 / P 5.9–6.5 / Cu rest
Melting range	650–810 °C
Joinable materials	Copper, gunmetal, brass, bronze
Flux required with	Gunmetal, brass, bronze with hard solder paste LP 5
Package size	250 g plastic bag

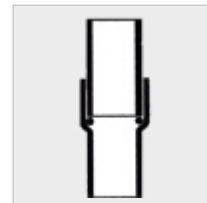


Model	Content	Weight	PU	No.
Hard solder rings S 2, Ø 14 mm	268 pcs.	0.260 kg	1	40514
Hard solder rings S 2, Ø 28 mm	79 pcs.	0.260 kg	1	40528

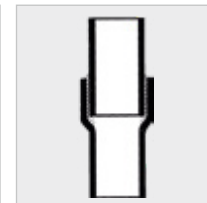
Simple insertion



Precise quantity of solder



Simply heat, no dripping, no reduction of cross-section



## Hard solder paste LP 5

Flux for brazing at working temperatures above 600 °C, according to EN 1045, type FH 10, DVGW tested Reg. No. DV-0101AT2245, for gas and water installations with copper pipes, recommended by DVGW according to worksheet GW 2 and GW 7, to be used with silver-containing brazing alloys and any base materials made of steel, copper and copper alloys, brass, gunmetal, effective temperature range 500–800 °C, flux residues must be removed carefully.

Model	Weight	PU	No.
LP 5 in plastic bottle	0.180 kg	1	40500



## Hard solder powder HKM

Flux for brazing at working temperatures above 800 °C, according to EN 1045 - FH 21, effective temperature range 800–1,100 °C, for copper and copper alloys, brass, red brass, nickel silver, bronze, steel and galvanized steel sheet, gray and malleable cast iron, to be used for welding copper and brass in dry condition, can be mixed to paste with purified water, flux residues must be removed carefully. Free of boric acid.

Model	Weight	PU	No.
HKM in plastic bottle	0.065 kg	1	35611





## ROLOT hard solders

### For copper pipe installation

ROTHENBERGER ROLOT special hard solders are particularly suited for copper pipe installations in cold and hot water systems, for open and closed heating systems, for gas installations in accordance with DVGW Worksheet GW 2 (liquid, natural and town gas) as well as for HVAC and refrigeration applications, and oil pipes. ROTHENBERGER ROLOT is especially suited for capillary soldering of copper pipes without fittings. Copper / phosphorus / silver solders are highly formable, and are therefore recommended for joints that are subjected to high thermal and mechanical alternating loads.

### Application Benefits

- Non-foaming
- Heat resistant up to 200 °C
- No flux required for copper/copper brazing (except S 34 and S 45)
- Environmentally friendly manufactured with newly developed production technology, corrosion-neutral, scale-free, improved flow behavior



## ROLOT S94 CuP 179

Quality hard solder guaranteed according to EN ISO 17672, due to low phosphorus content, the solder has a wide melting range, and creates soldered joints with increased strength. Standard solder for normally-stressed copper pipe installation, especially for capillary soldering with copper pipe installation without fittings.

### Technical Data

Alloy (weight %)	Cu 94 / P6
Melting range	710–880 °C
Working temperature	760 °C
Joinable materials	Copper, gunmetal, brass, bronze
Flux required with	Gunmetal, brass, bronze with LP 5



Content	Squared section mm	Length mm	Weight	PU	No.
1 kg carton	2×2	500	1.025 kg	1	40094

## ROLOT S 2

Special quality hard solder, not standardised, similar to EN ISO 17672, with low silver content, matched to normally-stressed copper pipe system, ideal for capillary gap soldering.

### Technical Data

Melting range	700–850 °C
Working temperature	760 °C
Joinable materials	Copper, gunmetal, brass, bronze
Flux required with	Gunmetal, brass, bronze with hard solder paste LP 5



Content	Squared section mm	Length mm	Weight	PU	No.
1 kg carton	2×2	500	1.025 kg	1	40202

**ROLOT S 2 CuP 279**

Silver /phosphorus safety hard solder, guaranteed according to EN ISO 17672, for higher-stressed copper pipe systems, ideal for capillary soldering in sanitary, heating and gas installations.

**Technical Data**

Alloy (weight %)	Ag 2 /Cu 91.8 / P 6.2
Melting range	645–825 °C
Working temperature	710 °C
Joinable materials	Copper, gunmetal, brass, bronze
Flux required with	Gunmetal, brass, bronze with hard solder paste LP 5



Content	Squared section mm	Length mm	Weight	PU	No.
1 kg carton	2×2	500	1.025 kg	1	40212
1 kg carton	3×3	500	1.025 kg	1	40213

**ROLOT S 5**

Particularly high-quality hard solder, not standardised, similar to EN ISO 17672, with low silver content, ideal for capillary and joint soldering in sanitary, heating and gas installations.

**Technical Data**

Melting range	710–840 °C
Working temperature	750 °C
Joinable materials	Copper, gunmetal, brass, bronze
Flux required with	Gunmetal, brass, bronze with hard solder paste LP 5



Content	Squared section mm	Length mm	Weight	PU	No.
1 kg carton	2×2	500	1.025 kg	1	40502

**ROLOT S 5 CuP 281**

High-quality silver/phosphorus safety hard solder, guaranteed according to EN ISO 17672, for higher-stressed copper pipe systems, ideal for capillary and joint soldering in sanitary, heating and gas installations.

**Technical Data**

Alloy (weight %)	Ag 5 /Cu 89 / P 6
Melting range	645–815 °C
Working temperature	710 °C
Joinable materials	Copper, gunmetal, brass, bronze
Flux required with	Gunmetal, brass, bronze with hard solder paste LP 5



Content	Squared section mm	Length mm	Weight	PU	No.
1 kg carton	2×2	500	1.025 kg	1	40005

**ROLOT S15 CuP 284**

Particularly high-quality silver hard solder, guaranteed according to EN ISO 17672, especially for capillary-gap soldering subject to high thermal and mechanical alternating loads in HVAC systems as well as demanding sanitary and gas installations.

**Technical Data**

Alloy (weight %)	Ag 15 / Cu 80 / P 5
Melting range	645–800 °C
Working temperature	700 °C
Joinable materials	Copper, gunmetal, brass, bronze
Flux required with	Gunmetal, brass, bronze with hard solder paste LP 5



Content	Squared section mm	Length mm	Weight	PU	No.
1 kg carton	2 × 2	500	1.025 kg	1	40015

**Silver hard solders Ag 134 S 34 Cu U flux-covered**

Free of cadmium, quality silver hard solder guaranteed according to EN ISO 17672, flux-covered according to EN1045 FH 10, universal application areas for gap soldering, also for drinking water installations, heat-resistant up to 200 °C.

**Technical Data**

Alloy (weight %)	Ag 34 / Cu 36 / Zn 27.5 / Sn 2.5
Melting range	630–730 °C
Working temperature	710 °C
Joinable materials	Steel, malleable cast iron, copper, gunmetal, copper and nickel alloys



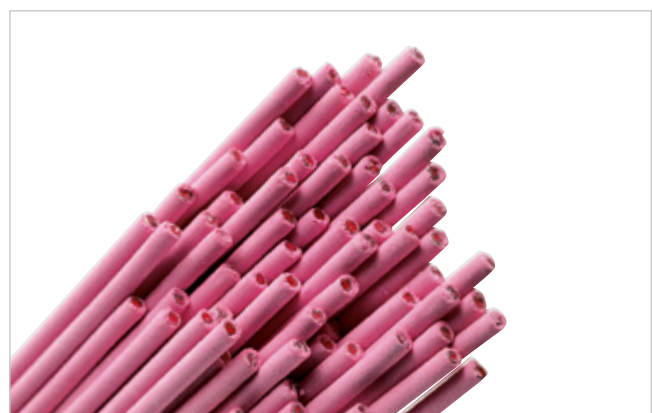
Content	Length mm	Weight	PU	No.
100 g plastic bag	2	0.110 kg	1	44915
250 g plastic bag	2	0.260 kg	1	44916
1,000 g plastic bag	2	1.010 kg	1	44917

**Silver hard solders Ag 145 S 45 Cu / S 45 Cu U flux-covered**

Free of cadmium, quality silver hard solder, guaranteed according to EN ISO 17672, flux-covered according to EN 1045, Type FH 10, universal application areas for gap soldering, excluding drinking water installations, heat-resistant up to 200 °C.

**Technical Data**

Alloy (weight %)	Ag 45 / Cu 27 / Zn 25.5 / Sn 2.5
Melting range	640–680 °C
Working temperature	670 °C
Joinable materials	Steel, malleable cast iron, copper, gunmetal, copper and nickel alloys, stainless steel



Content	Length mm	Weight	PU	No.
100 g plastic bag	2	0.110 kg	1	45055
250 g plastic bag	2	0.325 kg	1	45056










## Testing and leak detection



<b>System overview</b>	206-207
<b>Testing of water lines and containers</b>	
Testing pumps	208-211
<b>Testing of gas and water lines</b>	
Analogue testing device	212
Accessories testing devices	213
<b>Leak detection on gas and water lines</b>	
Leak detection on water lines	214
Leak detection on gas lines	215

Testing pumps, manual		
	RP 50 Digital	RP 50-S/ RP 50-S INOX
		
Testing and pressure range	0–30 bar	0–60 bar
Hub suction capacity	approx. 45 ml / stroke	approx. 45 ml / stroke
Tank capacity	12l	12l
Connection	R 1/2"	R 1/2"
Dimension (L × B × H)	495 × 165 × 255 mm	495 × 165 × 255 mm
Material	DURAMANT coated steel	DURAMANT coated steel
Valve	Twin valve	Twin valve
Pressure gauge units	bar, psi and MPa	bar, psi and MPa
Documentation via app	●	○
Suitable for	Water and glycol-water mixtures	Oil, water and glycol
<b>Page</b>	<b>208</b>	<b>209</b>

8

Testing pumps, manual		Testing pumps, electric	
	TP 25	RP 30	RP Pro III
			
Testing and pressure range	0–25 bar	0–30 bar	0–40 bar
Hub suction capacity	approx. 16 ml / stroke	approx. 16 ml / stroke	6l / min.
Tank capacity	7l	4,5l	○
Connection	R 1/2"	R 1/2"	R 1/2"
Dimension (L × B × H)	380 × 215 × 156 mm	440 × 200 × 240 mm	375 × 290 × 300 mm
Material	DURAMANT coated steel	ABS plastic	ABS plastic
Valve	Twin valve	Single valve	Single valve
Pressure gauge units	bar and psi	bar and psi	bar, psi and MPa
Documentation via app	○	○	○
Suitable for	Oil, water and glycol	Oil, water and glycol	Oil, water and glycol
<b>Page</b>	<b>211</b>	<b>211</b>	<b>210</b>

## Testing devices for gas and water connections

### ROTEST GW 150/4



Low pressure range	0-160 mbar (resolution 0.1 mbar / hPa)
High pressure range	0-4 bar (resolution 0.1 bar / 0.01 MPa)
Leak rate measurement	<input type="checkbox"/>
Display resolution	<input type="checkbox"/>
Data transfer	<input type="checkbox"/>
Battery life time	<input type="checkbox"/>
Safety class	<input type="checkbox"/>
<b>Page</b>	<b>212</b>

### ROLEAK Aqua 3 Plus



Frequency filter	1. stage: 0-540 Hz, 2. stage: 540-4,000 Hz, 3. stage: 0-4,000 Hz
Battery life time	approx. 15 h
Safety class	IP 41
<b>Page</b>	<b>214</b>

### ROTEST Electronic 4



Detects	Natural gas, propane, butane, methane, acetone, alcohol, ammonia, benzyl, ethylene, gasoline, hydrogen, industrial solvents, jet fuel, paint thinner, naphtha, toluene
Sensitivity	<50 ppm-1 Vol% (Methane)
<b>Page</b>	<b>215</b>

## Testing and leak detection

### Testing of water lines and containers

#### RP 50 Digital

##### Digital precision test pump for liquid-filled lines or containers up to 30 bar

Pressure tests with water on pipe systems in residential and commercial buildings and in industrially used tanks (up to 30 bar)

##### Application Benefits

- Digital pressure sensor up to 30 bar enables high-precision measurements and adjustment of the test pressure to be set
- Simple and automatic documentation of the test parameters
- Secure creation of a test protocol with the app
- An additional pressure gauge with drag indicator shows the set pressure so that a pressure drop in the system can be easily determined
- Reliable and precise measurement results: the double valve system (Twin Valve) enables self-testing of the pump as well as exact fine adjustment of the pressure
- Test hose with steel mesh prevents measurement errors that can occur due to expansion of the hose during operation
- Weathering and cold-resistant steel container with DURAMANT coating

##### Technical Data

Testing and pressure range	0–30 bar
Hub suction capacity	approx. 45 ml / stroke
Tank capacity	12 l
Connection	R 1/2"
Dimensions (L × B × H)	495 × 165 × 255 mm
Material	DURAMANT coated steel
Valve	Twin valve
Pressure gauge units	bar, psi and MPa
Suitable for	Water and glycol-water mixtures



##### Digital pressure sensor for measurements up to 30 bar

Wireless readout of the test data via Bluetooth® and creation of digital test protocols and visualizations of pressure curves

##### Additional pressure gauge with fine scaling 0.1 bar optional

Enables very precise readings up to a range of 16 bar (No. 61316)

##### Warp-resistant and lockable lever

Ergonomic handle serves as carrying grip too

##### Hook to fix the handle

Improved carrying comfort

##### TWIN VALVE system

Two valves for double safety while testing the system

##### 5 year warranty against corrosion

Extrem durable DURAMANT coating

##### Testing hose with steel mesh

Precise measurement



Digital pressure sensor enables precise adjustment of the test pressure

Creation of a test protocol via app



Model	Weight	PU	No.
RP 50 Digital	7.800 kg	1	1000004000



## RP 50-S / RP 50-S INOX

**Robust precision testing pump for pressure testing of water lines and containers up to 60 bar with very high testing standards**

Pressure testing with water or oil of piping in residential and industrial construction, as well as for industrial containers (up to 60 bar). Expansion possible with an extra fine scaling pressure gauge (0.1 bar) for testing up to 16 bars

### Application Benefits

- A drag indicator displays the preset pressure so that a loss of pressure in the system can be detected easier
- Reliable and precise testing results: the dual-valve system (Twin Valve) enables self-testing of the pump as well as a precise fine adjustment of the pressure
- Especially precise reading as needed: finely scaled (scaling 0.1 bar) pressure gauge available separately
- Testing hose with steel mesh prevents reading mistakes, that can happen when the hose expands during operation
- Type 50-S: weather and cold-resistant steel container with DURAMANT coating
- Type 50-S INOX: high-quality corrosion resistant stainless steel tank

**Adjustment of the pressure gauge with 0.1 bar scaling is possible!**



### Technical Data

Testing and pressure range	0–60 bar with 1 bar steps 0–860 psi with 20 psi steps 0–6 MPa with 0.1 MPa steps
Hub suction capacity	approx. 45 ml / stroke
Tank capacity	12 l
Connection	R 1/2"
Dimensions (L × B × H)	495 × 165 × 255 mm
Material RP 50-S	DURAMANT coated steel
Material RP 50-S INOX	Stainless steel
Valve	Twin valve
Pressure gauge units	bar, psi and MPa
Suitable for	Oil, water and glycol

### Additional pressure gauge with fine scaling 0.1 bar optional

Enables very precise readings up to a range of 16 bar (No. 61316)

### Testing hose with steel mesh

Precise measurement

### INOX

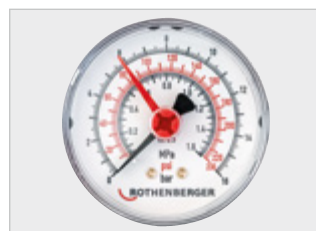


No. 60203

Double valve system: enables self-testing of the pump, as well as a precise fine adjustment of the pressure



Optional: Extra fine scaling Pressure gauge for the testing of systems up to 16 bar with a 0.1 scaling



### Warp-resistant and lockable lever

Ergonomic handle serves as carrying grip too

### Hook to fix the handle

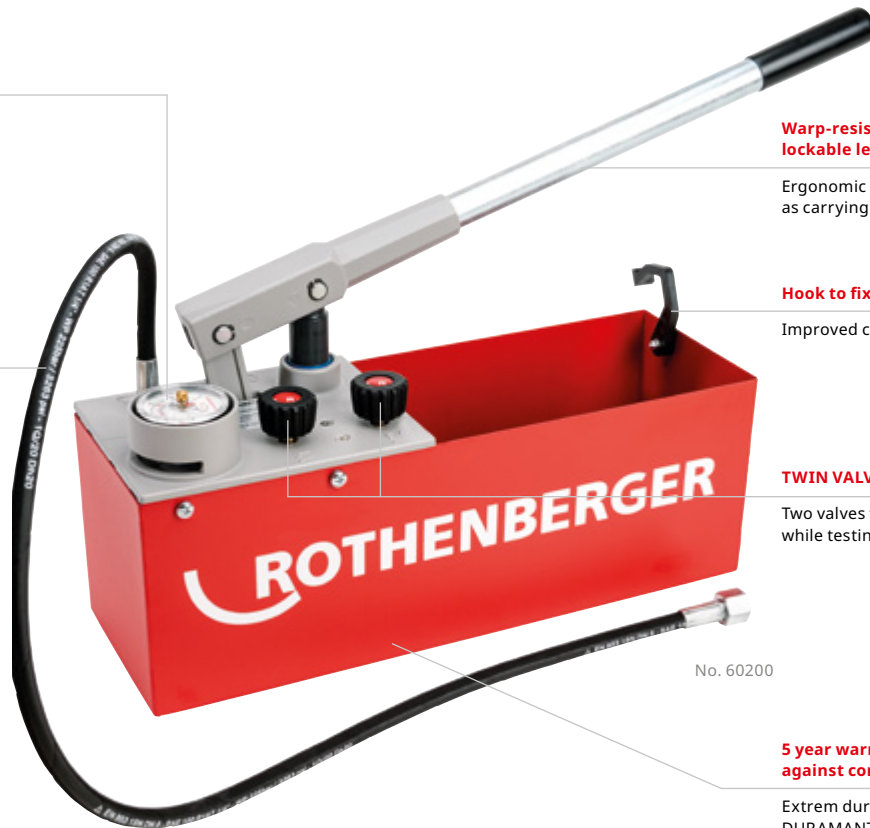
Improved carrying comfort

### TWIN VALVE system

Two valves for double safety while testing the system

### 5 year warranty against corrosion

Extrem durable DURAMANT coating



No. 60200

Model	Weight	PU	No.
RP 50-S	8.000 kg	1	60200
RP 50-S INOX	8.000 kg	1	60203
Maintenance package for RP 50-S	0.100 kg	1	60201
Double nipple 1/2" to 3/4"	0.100 kg	1	60999
High pressure hose with 1/4"	0.490 kg	1	R6112500
Extra 16 bar pressure gauge	0.100 kg	1	61316

## Testing and leak detection

### Testing of water lines and containers

#### RP Pro III

##### Self-priming electric testing pump up to 40 bar

Electrical testing pump for the automatic pressure testing of piping and containers up to 40 bar in accordance with national and international standards



#### Application Benefits

- Comfortable, automatic filling and pressure testing of piping and containers
- Compact and robust plastic casing for simple handling at the building site
- Liquid supply freely selectable: optional self-priming up to a maximum of 1 m or from a pressure source. Suitable for oil, water and glycol
- Testing hose with steel mesh prevents reading mistakes, that can happen when the hose expands during operation
- Glycerine cushioned pressure gauge absorbs pressure surges which makes pressure reading easier

#### Technical Data

Testing and pressure range:	0–40 bar with 1 bar steps 0–570 psi with 20 psi steps 0–0.1 MPa steps
Hub suction capacity	6 l/min.
Connection	R 1/2"
Dimensions (L × B × H)	375 × 290 × 300 mm
Material	ABS plastic
Pressure gauge units	bar, psi and MPa
Gauge characteristics	glycerine cushioned
Suitable for	Oil, water and glycol

#### Valve for pressure adjustment

Precise labelling on handle

#### Glycerine pressure gauge

Easy for the user to read during high dynamic alternating loads

#### Optimal weight distribution

Comfortable to carry

#### Thermal automatic shutdown

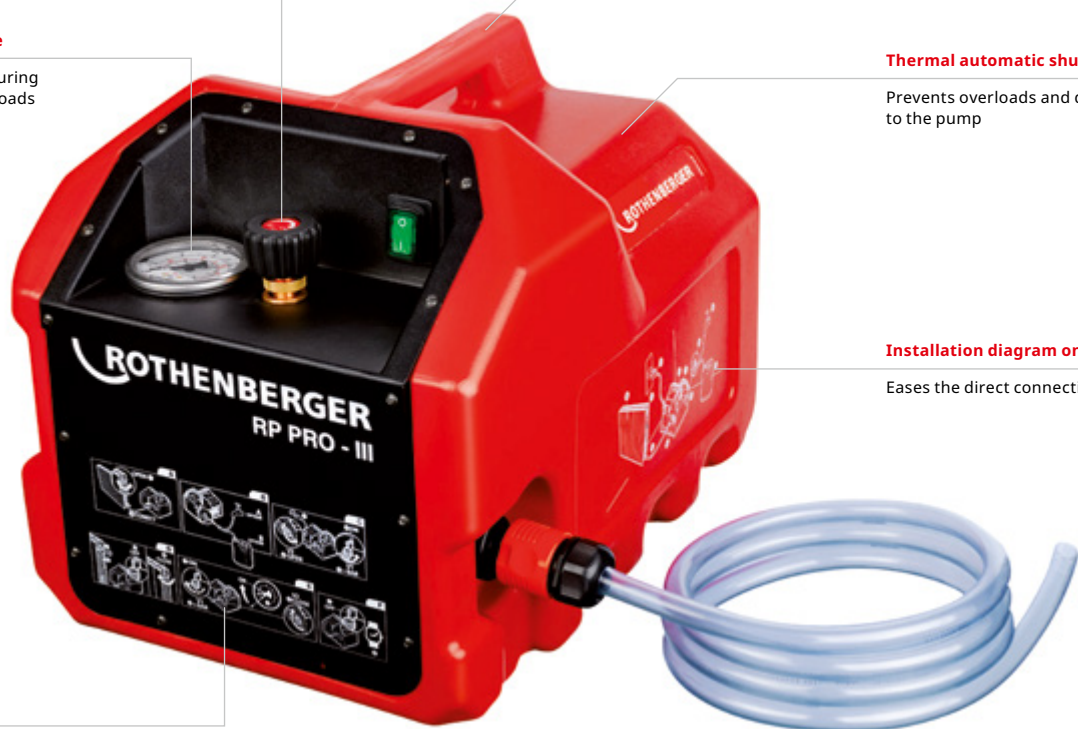
Prevents overloads and damage to the pump

#### Installation diagram on unit

Eases the direct connection

#### Function overview

Direct overview of the functions



Model	Weight	PU	No.
RP Pro III	16.000 kg	1	61185
Testing hose with R 1/2"	0.400 kg	1	V12102000
Maintenance package for RP Pro III	1.111 kg	1	61186

**TP 25****Small, robust precision testing pump for pressure testing up to 25 bar**

Pressure testing with water or oil of piping in residential and industrial construction as well as for industrial containers up to 25 bar in accordance with international and national standards

**Application Benefits**

- Reliable and precise testing results: the dual-valve system (Twin Valve) enables self-testing of the pump, as well as a precise fine adjustment of the pressure
- Testing hose with steel mesh prevents reading mistakes, that can happen when the hose expands during operation
- Weather and cold-resistant steel container with DURAMANT coating

**Technical Data**

Testing and pressure range	0–25 bar
Hub suction capacity	approx. 16 ml / stroke
Connection	R 1/2"
Dimensions (L × B × H)	380 × 215 × 156 mm
Material	DURAMANT coated steel

Model	Weight	PU	No.
TP 25	4.600 kg	1	60250
Maintenance package for TP 25	0.100 kg	1	60251



For daily use on the construction site:  
fits in any car

**RP 30****Simple and light testing pump for compression testing up to 30 bar**

Pressure testing with water or oil of piping in residential and industrial construction as well as for industrial containers up to 30 bar in accordance with international and national standards

**Application Benefits**

- Testing hose with steel mesh prevents reading mistakes, that can happen when the hose expands during operation
- Shock and corrosion resistant ABS plastic container with reinforced floor

**Technical Data**

Testing and pressure range	0–30 bar with 1 bar steps 0–440 psi with 20 psi steps
Hub suction capacity	approx. 16 ml / stroke
Connection	R 1/2"
Dimensions (L × B × H)	440 × 200 × 240 mm
Material	ABS plastic

Model	Weight	PU	No.
RP 30	4.500 kg	1	61130



Easy, light and handy: for all common  
house building applications



## Testing and leak detection

### Testing of gas and water lines

#### ROTEST GW 150/4

##### Analogue testing device for gas and water connections using air as the medium



Analogue testing unit for the implementation of the following tests:

- Gas:** Load and leakage test for newly installed gas lines in accordance with DVGW-TRGI Worksheet G 600 (October 2018)
- Leakage test from propane liquid gas lines / low-pressure liquid gas lines
- Adjustment of the duct pressure on atmospheric burners and forced-air burners
- Testing of the appliance connection pressure on gas appliances
- Water:** Pre-testing and testing of newly installed drinking water lines in accordance with DIN 1988 (TRWI)

#### Technical Data

Pressure gauge	4 bar / 0.4 MPa
Water column	150 mbar / hPa
Testing accuracy	Water column 0.1 mbar / hPa (Reading accuracy in accordance with TRGI) Pressure gauge 0.1 bar / 0.01 MPa (Display range 0–4 bar / 0–0.4 MPa)

#### Application Benefits

- Quick and precise pressure reading over water column without electronic
- Testing time and pressures in accordance with DVGW-TRGI and TRWI clearly arranged on unit cover
- Sturdy unit: High reliability when used on the building site

**DVGW-TRGI worksheet G 600 (October 2018) conforming!**



#### Legible scaling

Continuous scaling up to 150 mbar

#### Measurement chart in unit

Testing times and testing pressure from lawmakers at a glance

#### Inspection glass

Water level control

#### Foam inlay

High transport safety and protection of the components

#### Compact measuring station

Designed to serve in real-life situations through quick, exact gas pressure measurements

Testing scale up to 150 mbar on transparent extending tube element



Transparent tube element with double o-ring seal



Model	Weight	PU	No.
ROTEST GW 150/4 with 5 test plugs and supply end cap	7.570 kg	1	61700
ROTEST GW 150/4 with 5 test plugs without supply end cap	7.300 kg	1	61701

## Set components for ROTEST GW

Model	Weight	No.
Pressure pump for GW 150/4	0.300 kg	61011
Bellow for GW 150/4	0.055 kg	61014
Shut-off valve NW5 socket/plug	0.200 kg	61017
Adaptor nozzle pressure to NW5 plug	0.200 kg	61018
O-Ring set for GW 150/4, 6 pcs.	0.040 kg	61030
Supply end cap for GW 150/4 (NW 5)	0.380 kg	61041
1/2" adaptor to NW5 plug	0.500 kg	1500002876
Tube element for GW 150/4, 4 pcs.	1.100 kg	61702
Measurement fluid for GW 150/4, blue	0.100 kg	351257
Hose 2 m, high pressure with shut-off valve	0.200 kg	1500002845
Hose 2 m, low pressure	0.200 kg	1500002846
Double bellow for GW Digital V3	0.100 kg	1500002847
Air pump for GW Digital V3	0.140 kg	1500002848
CD RoData V3 for GW Digital V3	0.020 kg	1500002851



## Gas test plug / adaptor for ROTEST GW

Suitable for gas lines up to 1.5 bar

Model	Steel exterior pipe Ø inch	Copper exterior pipe Ø mm	Weight	PU	No.
Conical shape with pneumatic connection					
Size 0	3/8-1/2"	15-18	0.045 kg	1	351260
Size 1	1/2-1"	22-28	0.080 kg	1	351261
Size 2	3/4-1.1/4"	35-42	0.125 kg	1	351262
Size 3	1.1/4-2"	54-64	0.175 kg	1	351263
Cylindrical shape with pneumatic connection					
Size 1	3/4"	22	0.060 kg	1	351271
Size 2	1"	28	0.075 kg	1	351272
Conical shape with hose coupling					
Size 0	3/8-1/2"	15-18	0.200 kg	1	351220
Size 1	1/2-1"	22-28	0.300 kg	1	351221
Size 2	3/4-1.1/4"	35-42	0.300 kg	1	351222
Size 3	1.1/4-2"	54-64	0.400 kg	1	351223
Conical shape with 2 ball valves					
Size 1	1/2-1"	22-28	0.260 kg	1	351231
Size 2	3/4-1.1/4"	35-42	0.420 kg	1	351232
Size 3	1.1/4-2"	54-64	0.700 kg	1	351233
Conical shape with 1 ball valve					
Size 0	3/8-1/2"	15-18	0.200 kg	1	351225
Size 1	1/2-1"	22-28	0.350 kg	1	351226
Size 2	3/4-1.1/4"	35-42	0.390 kg	1	351227
Size 3	1.1/4-2"	54-64	0.600 kg	1	351228
With double plug valve and hose snout					
Adaptor with pn. connection			0.290 kg	1	351265



## ROLEAK Aqua 3 Plus

Easy to use leak detection device with acoustic signal for pipe systems

### Application Benefits

- Leak detection possible on different pipe materials
- Amplifies flow noise and enables leaks to be located
- Digital wireless connection to headphones
- Possibility to connect an external microphone
- Bluetooth® connection for a better and clear noise transmission to headphones. This also allows to control the volume with the handunit



### Technical Data

Frequency filter	1. stage: 0 up to 540 Hz 2. stage: 540 up to 4,000 Hz 3. stage: 0 up to 4,000 Hz
Battery life time	approx. 15 h
Safety class	IP 41



Even better acoustics thanks to Bluetooth® wireless technology



8

External groundmicrophone



No. 1500003535

Acoustic leak detection of heating installations



6-parts Set (No. 1500003533) includes: basic unit, headphones, magnetic adaptor, 2x extensionstick, tripod-adaptor, ROCASE 4414

Model	Weight	PU	No.
ROLEAK Aqua 3 Plus	3.100 kg	1	1500003533
External groundmicrophone	0.500 kg	1	1500003535



## ROTEST Electronic 4

### Leak detection on gas lines

For the detection of gas in room as well as leaks in pipes. Detects all flammable methane based gases

#### Application Benefits

- Leaks are optically as well as acoustically displayed
- With the help of the 42 cm long, flexible testing head and the integrated lamp, even dark and hard to reach places can be tested
- Quick and precise leak location of even the smallest leak source: The sensitivity of the unit can be adjusted continuously in a range from <math><50\text{ ppm}</math>–1 Vol %
- Shock-proof soft case jacket and simple one-handed operation of the unit for use on the building site

#### Technical Data

Detects	Natural gas, propane, butane, methane, acetone, alcohol, ammonia, benzyl, ethylene, gasoline, hydrogen, industrial solvents, jet fuel, paint thinner, naphtha, toluene
Sensitivity	<math><50\text{ ppm}</math>–1 Vol % (Methane)



Set (No. 1000003199) includes: ROTEST Electronic 4, 2 × AA battery in ROCASE 4212 (No. 1300003334)

Model	Weight	PU	No.
ROTEST Electronic 4	1.250 kg	1	1000003199

Finds leaks easily



8

## Leak detection spray

### Leak detection on gas lines

Ideal for detecting leaks in gas-filled lines, gas cylinders or containers. When a leak is present a blister forms

#### Application Benefits

- Simple use—always ready to use
- Highly sensitive foaming spray for a quick and reliable locating of leaks

#### Technical Data

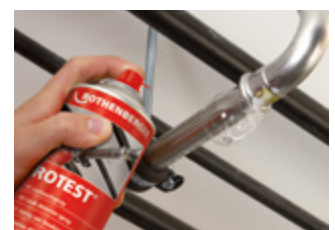
- Detects gases (for example natural gas, inflammable gas or air)
- The leak detection spray is neutral against the most common inflammable gases and refrigerants. The only reaction is the building of foam

Highly sensitive foam spray for quick and reliable location of leaks



DVGW-tested  
Reg.-No. NG-5170CL0063

Model	Weight	PU	No.
ROTEST leak detection spray 400 ml	0.470 kg	1	65000
ROTEST leak detection spray 400 ml, 12 pcs.	5.670 kg	12	1000000442












## Freezing



<b>System overview</b>	218
<b>Freezing electric</b> Pipe freezing systems	218-222
<b>Freezing with gas</b> Pipe freezing systems	223

## Freezing

### System overview

	Freezing electric		Freezing with gas
	ROFROST Turbo II R290 1.1/4"	ROFROST TURBO II R290 2"	ROFROST CO <sub>2</sub> Set
			
Working range Cu	10–42 mm (3/8–1.3/8")	10–54 mm (3/8–2.1/8")	10–54 mm (3/8–2.1/8")
Working range Fe	1/8–1.1/4"	1/8–2"	1/8–2"
Reduction inserts	up to 12 pcs.	up to 15 pcs.	up to 10 pcs.
Freezing hose	2.000 m	2.000 m	2.000 m
Refrigerant	R290	R290	CO <sub>2</sub> (R744)
<b>Page</b>	<b>219</b>	<b>220</b>	<b>223</b>

## ROFROST TURBO II R290 1.1/4" / ROFROST Turbo II R290 2"

### Pipe freezing system for copper, steel and stainless steel

#### Flexible refrigerant hoses

Work in confined spaces and store the hoses inside the unit

#### Simple clamping system ROFROST TURBO R290 1.1/4"

For use even in confined spaces

#### Compact design

Tough powder coated metal case with soft-grip handle makes the machine highly mobile and ideal for service work

#### Heat conductive paste

Enables freezing without continuous spraying of the pipe

#### Wide application area

A range of pipe sizes can be frozen using the supplied pipe inserts



The use of heat conductive paste guarantees optimal freezing



The freezing process starts automatically after installing the freezing clamps



Compact freeze clamp design allows the pipe to be frozen—even close to the wall



## ROFROST TURBO II R290 1.1/4"

### Pipe freezing system for copper, steel and stainless steel

Maintenance, repair and expansion work in sanitary and heating installations.

**Copper pipes:** Ø 10–42 mm ROFROST Turbo II R290 1.1/4"  
Ø 3/8–1.3/8" ROFROST Turbo II R290 1.1/4"

**Steel pipes:** Ø 1/8–1.1/4" ROFROST Turbo II R290 1.1/4"

### Application Benefits

- Future-proofed due to the change of the environmentally friendly refrigerant R290
- Compact freezing clamps and shortened thermometer allow working on confined spaces
- The use of heat conductive paste guarantees an optimum icing. It prevents air pockets between the freezing clamps and pipe. The pipe does not need to be sprayed with water
- Reduction inserts in various sizes for all common pipe diameters
- Over 20 % lighter compared to previous device



### Technical Data

Voltage	220–240 V
Working area diameter copper pipe	10–42 mm
Working area diameter steel pipe	1/8–1.1/4"
Power cable length	2 m



9

Model	Weight	PU	No.
ROFROST TURBO II R290 set 1.1/4", 6 reduction inserts, 230 V	23.500 kg	1	1500004195

## Freezing

### Freezing electric

#### ROFROST TURBO II R290 2"

##### Pipe freezing system for copper, steel and stainless steel

Maintenance, repair and expansion work in sanitary and heating installations

**Copper pipes:** Ø 10–54 mm ROFROST Turbo II R290 2"  
Ø 3/8–2.1/8" ROFROST Turbo II R290 2"

**Steel pipes:** Ø 1/8–2" ROFROST Turbo II R290 2"

##### Application Benefits

- Future-proofed due to the change of the environmentally friendly refrigerant R290
- Safe freezing: Thermometer on the freezer clamp indicates when the pipe is completely frozen
- The use of heat conductive paste guarantees an optimum icing. It prevents air pockets between the freezing clamps and pipe. The pipe does not need to be sprayed with water
- Reduction inserts in various sizes for all common pipe diameters
- Over 20% lighter compared to previous device



##### Technical Data

Voltage	220–240 V
Working area diameter copper pipe	10–54 mm
Working area diameter steel pipe	1/8–2"
Power cable length	2 m



##### Model

ROFROST TURBO II R290 set 2", 8 reduction inserts, 230 V

##### Weight

24.300 kg

##### PU

1

##### No.

1500004196

## ROFROST App

The ROFROST App supports safe work and the freezing process will be explained step by step.



**Application instructions**

**Application instructions**  
Check if you have performed the following steps

1. Waterflow interrupted?
2. Select the suitable reduction inserts?
3. Heat conductive paste used?
4. Correct mounted clamp at the pipe?
5. Switched on the ROFROST Turbo R 290?

Next step

Imprint

Checklist for the freezing process

**Freezing parameter**

**Freezing parameter**  
Select the freezing parameter

ROFROST Turbo R 290 1.1/4" recognized ➤  
Serial number 3108180080055

Pipe material	Copper (Cu)
Pipe diameter	Ø 22

Recommended minimum freezing time:  
**14 minutes**

Apply freezing parameter

Imprint

The recommended freeze time is displayed by adjusting the material and diameter

**Timer**

**Timer**  
Start the freezing process with the following parameters:  
ROFROST Turbo R 290 1.1/4"  
Pipe material Copper (Cu)  
Pipe diameter Ø 22

Recommended minimum freezing time:  
**14 minutes**

14:00

Start timer

Imprint

The integrated timer will respond after the freezing time has elapsed

## Reducer insert ROFROST TURBO II 1.1/4"

For freezing during maintenance, repair and extension work in the sanitary and heating installation of copper pipes from 10–42 mm or 3/8–1.3/8", as well as steel pipes from 1/8–1.1/4"



Model	Weight	PU	No.
Reduction inserts Size I, Cu 10 mm, Cu 3/8", Fe 1/2"	0.200 kg	1	62217
Reduction inserts Size II, Cu 12 mm, Cu 1/2"	0.180 kg	1	62211
Reduction inserts Size III, Cu 14/15 mm, Fe 1/4"	0.155 kg	1	62212
Reduction inserts Size IV, Cu 16 mm, Cu 5/8"	0.100 kg	1	62219
Reduction inserts Size V, Cu 18 mm, Fe 3/8"	0.145 kg	1	62213
Reduction inserts Size VI, Cu 20 mm, Cu 3/4"	0.154 kg	1	62224
Reduction inserts Size VII, Cu 22 mm, Cu 7/8", Fe 1/2"	0.130 kg	1	62214
Reduction inserts Size VIII, Cu 1"	0.200 kg	1	62226
Reduction inserts Size IX, Cu 28 mm, Fe 3/4"	0.105 kg	1	62215
Reduction inserts Size X, Cu 1.1/8"	0.200 kg	1	62227
Reduction inserts Size XI, Cu 32 mm, Cu 1.1/4"	0.200 kg	1	62221
Reduction inserts Size XII, Cu 35 mm, Cu 1.3/8", 1"	0.070 kg	1	62216
Expansion set for ROFROST TURBO Size II, III, V, VII	0.700 kg	1	62230

## Freezing

### Freezing electric

#### Reducer insert ROFROST TURBO II 2"

For freezing during maintenance, repair and extension work in the sanitary and heating installation of copper pipes from 10–54 mm or 1/2–2.1/8", as well as steel pipes from 10–54 mm



Model	Weight	PU	No.
Reduction inserts Size A, Cu 28 mm, Fe 3/4"	0.430 kg	1	62231
Reduction inserts Size B, Cu 1.1/8"	0.343 kg	1	62232
Reduction inserts Size C, Cu 32 mm, Cu 1.1/4"	0.310 kg	1	62233
Reduction inserts Size D, Cu 35 mm, Cu 1.3/8"	0.290 kg	1	62234
Reduction inserts Size E, Cu 42 mm, Fe 1.1/4"	0.220 kg	1	62235
Reduction inserts Size F, Fe 1.1/2"	0.160 kg	1	62236
Reduction inserts Size G, Cu 54 mm, Cu 2.1/8"	0.200 kg	1	62237

The reduction insert size E, 42 mm serves as an adaptor piece for fitting ROFROST Turbo 1.1/4" reduction inserts No. 62217 and No. 62211

#### ROFROST heat conductive paste

Thermal compound for use when freezing copper pipes from 10–54 mm or steel pipes from 1/8–2"

##### Application Benefits

- Heat conductive paste enables fully automatic freezing without spraying!



For a perfect freezing result



Heat conductive paste enables fully automatic freezing without spraying!

Model	Weight	PU	No.
ROFROST heat conductive paste 150 ml	0.150 kg	1	62291

## ROFROST CO<sub>2</sub> Set

Freezing unit for the freezing of pipes up to 2" without electricity

Maintenance, repair and expansion work in sanitary and heating installation. No electrical connection required

### Application Benefits

- Flexible use, freezing possible without electricity
- Because of the low temperature (up to -79 °C) the dry ice enables a faster freezing as every other electrical freezing unit that uses refrigerant
- Piping up to 2" can be frozen with just one unit
- Freezer heads made out of extremely cold-resistant special plastic

### Technical Data

Working area diameter copper pipe	10–54 mm
Working area diameter steel pipe	1/8–2"

Set without carbon dioxide bottles!

RO  
CASE



Model	Weight	PU	No.
ROFROST CO <sub>2</sub> Set Cu 10–54 mm, Cu 1/2–2.1/8", Fe 1/8–2"	4.900 kg	1	65030

## ROFROST Freezer Heads

Freezer head for the ROFROST dry ice set. For freezing copper pipes up to 60 mm and steel pipes up to 2"

Freezer head for maintenance, repair and expansion work in sanitary and heating installations. No power connection required

### Application Benefits

- Freezer head for the ROFROST dry ice set



Model	Weight	PU	No.
ROFROST freezer heads Size 1, Cu 10–12 mm, Cu 1/2", Fe 1/8"	0.060 kg	1	65035
ROFROST freezer heads Size 2, Cu 14–15 mm, Fe 1/4"	0.060 kg	1	65036
ROFROST freezer heads Size 3, Cu 16–18 mm, Cu 5/8", Fe 3/8"	0.070 kg	1	65037
ROFROST freezer heads Size 4, Cu 22 mm, Cu 3/4–7/8", Fe 1/2"	0.070 kg	1	65038
ROFROST freezer heads Size 5, Cu 28 mm, Cu 1.1/8", Fe 3/4"	0.110 kg	1	65039
ROFROST freezer heads Size 6, Cu 35 mm, Cu 1.3/8", Fe 1"	0.110 kg	1	65040
ROFROST freezer heads Size 7, Cu 42 mm, Cu 1.5/8", Fe 1.1/4"	0.210 kg	1	65041
ROFROST freezer heads Size 8, Fe 1.1/2"	0.210 kg	1	65042









## Inspection and locating



<b>System overview</b>	226-227
<b>Video inspection</b>	
ROSCOPE MINI	228
ROSCOPE i2000 and ROCAM 4 PLUS app	229
ROCAM MINI HD	230
Locating module ROLOC PLUS HD	231
ROCAM 4 PLUS	232-234
Accessories video inspection	235

	ROSCOPE MINI		ROCAM MINI HD		
	ROSCOPE MINI		ROCAM MINI HD	Module 25/22 HD	Module ROLOC PLUS HD
					
Application	Hollow spaces	Application	Hollow spaces	Residential	Locating of sondes
Pipe diameter	<input type="radio"/>	25 mm camera head	<input type="radio"/>	Ø 40-100 mm	<input type="radio"/>
Display size	2.5"	30 mm camera head	<input type="radio"/>	<input type="radio"/>	<input type="radio"/>
Touchscreen	<input type="radio"/>	40 mm camera head	<input type="radio"/>	<input type="radio"/>	<input type="radio"/>
Cable length	1.2 m	Display size	7"	7"	7"
Cable diameter	5.5 mm	Touchscreen	<input checked="" type="radio"/>	<input checked="" type="radio"/>	<input checked="" type="radio"/>
Camera head	Ø 8.5 mm	Cable length	1 m	22 m	<input type="radio"/>
Self levelling	180° digital rotatable	Metre counter	<input type="radio"/>	<input type="radio"/>	<input type="radio"/>
Transmitter	<input type="radio"/>	Cable diameter	7 mm	7 mm	<input type="radio"/>
Frequency	<input type="radio"/>	Self levelling	<input checked="" type="radio"/>	<input checked="" type="radio"/>	<input type="radio"/>
Picture format	JPG	Transmitter	<input type="radio"/>	<input checked="" type="radio"/>	<input type="radio"/>
Picture resolution	320 × 240 px	Frequency	<input type="radio"/>	512 Hz	512 Hz, 640 Hz, 33 kHz
Video format	<input type="radio"/>	Picture format	JPG	JPG	<input type="radio"/>
Video resolution	<input type="radio"/>	Picture resolution	1,920 × 1,080 px	1,920 × 1,080 px	<input type="radio"/>
Storage	Built-in memory	Video format	AVI	AVI	<input type="radio"/>
Wi-Fi transmitter	<input type="radio"/>	Video resolution	1,920 × 1,080 px	1,920 × 1,080 px	<input type="radio"/>
Protocol feature	<input type="radio"/>	Storage	SD card	SD card	<input type="radio"/>
Audio recording	<input type="radio"/>	Wi-Fi transmitter	<input checked="" type="radio"/>	<input checked="" type="radio"/>	<input type="radio"/>
Data handling	<input type="radio"/>	Protocol feature	<input checked="" type="radio"/>	<input checked="" type="radio"/>	<input type="radio"/>
		Audio recording	via headphones	via headphones	<input type="radio"/>
		Data handling	via app	via app	via app
<b>Page</b>	<b>228</b>	<b>Page</b>	<b>230</b>	<b>230</b>	<b>231</b>

**ROCAM 4 PLUS**

**ROCAM 4 PLUS 30 m**

**ROCAM 4 PLUS 65 m**

**Mini module**



Application	Municipal	Municipal	Residential
25 mm camera head	○	○	Ø 40–100 mm
30 mm camera head	Ø 70–150 mm	Ø 70–150 mm	○
40 mm camera head	Ø 100–300 mm	Ø 100–300 mm	○
Display size	10.4"	10.4"	10.4"
Touchscreen	●	●	●
Cable length	30 m	65 m	16 m
Metre counter	●	●	●
Cable diameter	7 mm	7 mm	5.5 mm
Self levelling	●	●	○
Transmitter	●	●	○
Frequency	33 kHz	33 kHz	○
Picture format	JPG	JPG	JPG
Picture resolution	720 × 600 px	720 × 600 px	720 × 600 px
Video format	AVI	AVI	AVI
Video resolution	720 × 600 px	720 × 600 px	720 × 600 px
Storage	SD card	SD card	SD card
Wi-Fi transmitter	●	●	●
Protocol feature	●	●	●
Audio recording	●	●	●
Data handling	via app	via app	via app
<b>Page</b>	<b>232</b>	<b>233</b>	<b>233</b>

**ROSCOPE MINI**

A constant companion—by having an extremely compact design, it can be stowed tidily into every tool case. Minor works, like the inspection of hollow spaces are not a challenge anymore. The combination of its robust construction with modern technology makes it a tool for every toolbox



**Application Benefits**

- Intuitive handling with the first touch
- The Ø8.5 mm camera head and the 120 cm camera cable are perfect for minor works and are maximizing the pace of work
- Electronical 180° rotation for the perfect perspective in every situation
- Waterproofed camera head
- Tool less mounting of accessories like the magnet or 90° mirror

**Technical Data**

Dimensions	152 × 90 × 40 mm
Resolution	320 × 240 px
Display size	2.5"
Cable length	1.2 m
Cable diameter	5.5 mm
Cable head	Ø8.5 mm
Leveling	180° digital rotatable
Storage	30 pictures

**Adjustable illumination**

7 light levels for best lighting conditions

**180° rotatable picture**

Fast and precise analysis on a 2.5" display with triple zoom

**Intuitive handling**

Self-explanatory service in live and review mode

Quick inspection of hollow spaces before and after installations



Always ready to hand, due to handy belt clip



**Ø8.5 mm waterproof camera head**

Perfect working conditions in small diameters

**1.2 m camera cable**

For quick and easy inspection

**Included belt clip**

Comfortable wear



**Space-saving storage**

can be easily wound up around

**Accessories included**

Integrated magnet for catching metal pieces and mirror for the perfect view in a 90° bow



Magnet-accessory



Mirror-accessory

Set (No. 1000002268) includes: ROSCOPE MINI basic unit, mirror and magnet accessories, 4 × AA batteries, ROBOX B2350 (No. 1500002641)

Model	Weight	PU	No.
ROSCOPE MINI set	0.530 kg	1	1000002268

## ROTHENBERGER apps

Apps for smartphone and tablet to edit and send recorded image data



### Application Benefits

- Wi-Fi transmitter allows a image transfer live from the camera to mobile devices
- Integrated editing function to mark and name specific pipeline damages
- Synchronizing of stored images of the camera to allow further processing
- Sending of edited pictures directly from the place of action
- Automatic generation of a damage report in PDF, which is individually customizable

### Technical Data

#### ROSCOPE i2000

Compatibility iOS 5.1–13.0, Android 4.0 or newer

Size 4.1 MB

#### ROCAM 4

Compatibility iOS 8.1 or newer, Android 4.0 or newer

Size 12 MB

#### ROTHENBERGER app

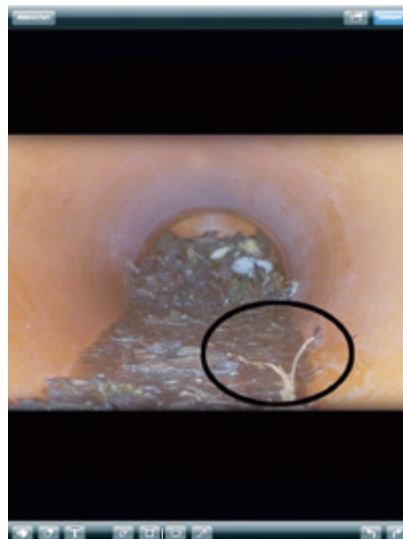
Compatibility iOS 8.1 or newer, Android 4.0 or newer

Size 73.3 MB

### Live image



### Editing display



### Album



Album

Picture and video recording

Settings/ notes

Editing

- Color palette
- Pen and rubber
- Text
- Rectangle, circle, arrow

Available for iOS (until version 13.0) and Android!

The ROCAM 4 PLUS and ROSCOPE i2000 apps will be integrated into the ROTHENBERGER app in 2023.

Transfer to mobile device



Sending of edited pictures directly from the place of action



## ROCAM MINI HD module 25/22 HD

### Cordless inspection camera

In residential area for pipes from Ø40–110 mm



#### Application Benefits

- Full-HD and TrueColor for fast and accurate analysis
- 22 m cable for more independence
- Optimized cable stiffness and head geometry to pass up to six 90° bends (50 mm tubes) / three 90° bends (40 mm tubes)
- Integrated Bluetooth® module for connecting headphones to add voice recording
- Wi-Fi module for perfect connection between smartphone and ROCAM MINI HD. With the help of the app, the entire gallery of the ROCAM MINI HD can be accessed and shared directly.
- Livestream function via app to share the screen with the customer for a professional appearance

#### Technical Data

Battery voltage	18 V
Application range	Ø40–110 mm
Picture and video resolution	1,920 × 1,080 px
Cable diameter	7 mm
Camera head	Ø25 mm
Storage type	SD card 32 GB
Locator transmitter	512 Hz
Waterproof	10 m
Display	Touchscreen 7"

#### 7" Full-HD Touchscreen

For intuitive operation and direct documentation with damage catalog directly on the device

#### Waterproof housing

Enables working on roofs—even in the rain

#### Compact Ø25 mm head

Covers an application range from Ø40–110 mm

#### 512 Hz sensor

Can be tracked with the ROLOC PLUS HD

The additional internal battery bridges the time without power supply and enables continuous operation



Livestream transmission to a mobile device for a professional appearance at the customer



#### App functionality

Full functions for live streaming and easy data sharing via iOS and Android

#### Multiple battery systems

Suitable for AMPShare or CAS battery systems

#### 22 m reel

For inspecting pipelines of multi story family houses



Available in the manufacturer-independent battery systems AMPShare – Powered by Bosch or CAS – CORDLESS ALLIANCE SYSTEM

Set (No. 100003922) includes: ROCAM MINI HD display, module 25/22 HD, module TEC, guidance ball, RO BP18/2, 2.0Ah 18V battery, RO BC14/36 charger, RO CASE 6427 with thermoformed insert

Model	Weight	PU	AMPShare-No.	CAS-No.
Module 25/22 reel	5.000 kg	1	1000004125	1000003920
ROCAM MINI HD, display incl. module TEC	3.800 kg	1	1000004126	1000003921
ROCAM MINI HD, module 25/22 HD, set EU	9.000 kg	1	1000004127	1000003922
ROCAM MINI HD, module 25/22 HD, set UK	9.000 kg	1	1000004128	1000003965
ROCAM MINI HD, module 25/22 HD, baretool	8.600 kg	1	1000004131	1000003960

### ROCAM MINI HD module ROLOC PLUS HD

#### Probe locator for locating the camera head of the ROCAM MINI HD module 25/22 HD

The ROLOC PLUS module is suitable for precise locating of the camera head of the ROCAM MINI HD module 25/22 HD as well as the camera heads Ø 30 mm and Ø 40 mm of the ROCAM 4 PLUS. Other locating sensors with compatible frequency can also be located.

#### Application Benefits

- Pinpoint localization of probes
- Exact depth measurement
- Different frequencies selectable
- Optimized menu design guides step by step through the locating process
- Telescope function for convenient transport in the case

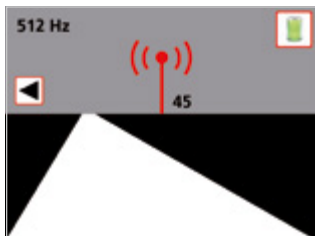
#### Technical Data

Functional range	Vertical 0.6–1.8 m Horizontal 0–4.5 m
Frequencies	512 Hz, 640 Hz, 50/60 Hz passive, 33 KHz active/passive
Depth measurement	1.5 m

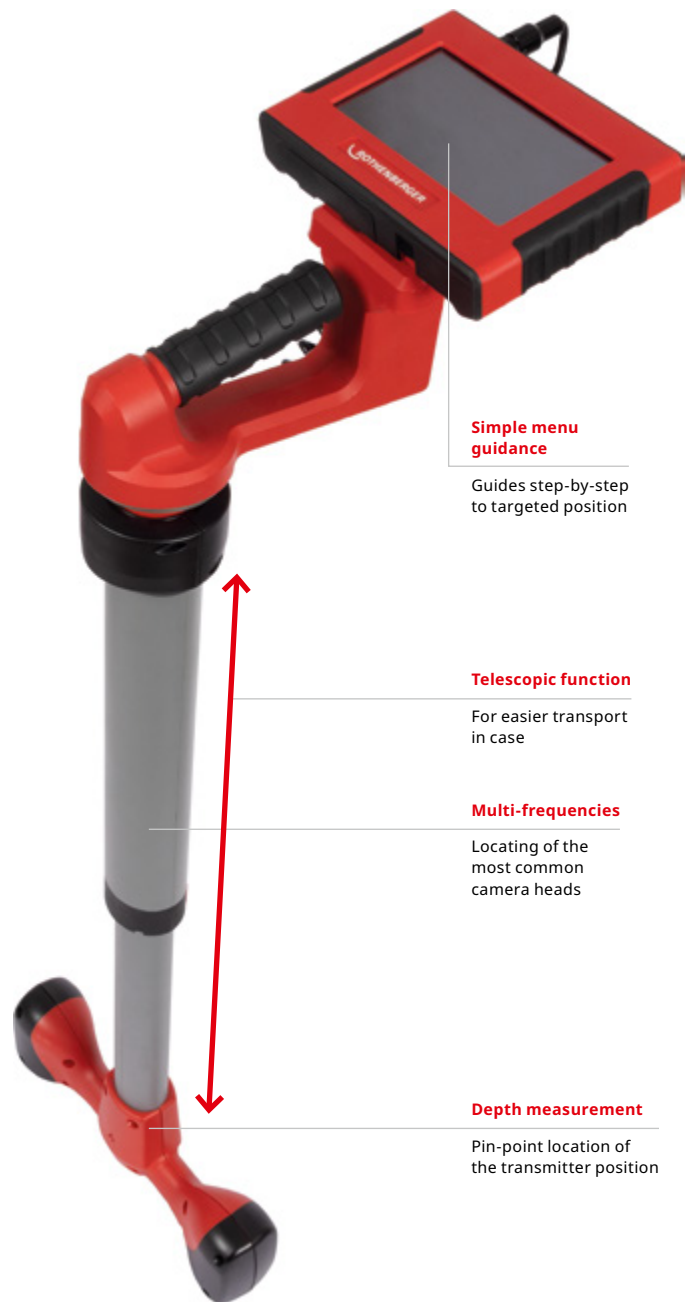
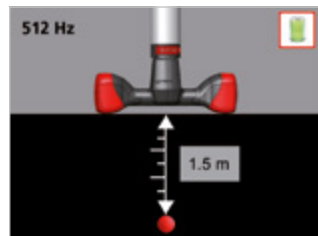
With the help of the ROLOC PLUS HD module the locating transmitter can be quickly and easily found



Target is left of the running direction. Correction of your direction to the left is necessary.



Depth measurement with a push of the button



#### Simple menu guidance

Guides step-by-step to targeted position

#### Telescopic function

For easier transport in case

#### Multi-frequencies

Locating of the most common camera heads

#### Depth measurement

Pin-point location of the transmitter position

Available in the manufacturer-independent battery systems AMPShare - Powered by Bosch or CAS - CORDLESS ALLIANCE SYSTEM

#### Model

Model	Weight	PU	AMPShare-No.	CAS-No.
ROCAM MINI HD, module ROLOC PLUS HD, set EU	8.900 kg	1	1000004133	1000003963
ROCAM MINI HD, module ROLOC PLUS HD, baretool	7.900 kg	1	1000004137	1000003964
ROLOC PLUS HD	4.500 kg	1	1000004132	1000003962

**ROCAM 4 PLUS 30 meter**

Inspection camera for pipes from Ø 40–300 mm with 30 or 65 m cable length, with integrated software for documentation and large removable 10.4" touchscreen.



**Application Benefits**

- Picture editing, change of camera settings and menu guidance via the 10.4" color-touchscreen
- Direct recording of pictures (JPG) or video (AVI, resolution 720 x 600 px) as well as editing options (e.g. documentation of damage)
- Fast data recording with integrated keyboard to mark, highlight and name damages
- Picture and video transmission via Wi-Fi, Micro-HDMI, Mini-USB, SD card
- Livestream of picture and data via Wi-Fi to the ROCAM 4 app
- Self-levelling and exchangeable camera heads
- Exchangeable reels for various working ranges
- New platform based battery technology

Please note: This machine cannot be upgraded to a 65 m cable.

**Technical Data**

Picture and video format	JPG / AVI (resolution 720 x 600 px)
Camera head	Ø 25 mm, waterproof with 8 LEDs
	Ø 30 mm, self-levelling and waterproof with 10 LEDs
	Ø 40 mm, self-levelling and waterproof with 36 LEDs
Working range	Ø 40–100 mm (mini module)
	Ø 70–150 mm (30 mm camera head)
	Ø 100–300 mm (40 mm camera head)
Cable length	65 m version
	30 m version
	16 m mini module (optional)
Cable diameter	7 mm (30 m and 65 m reel)
	5.5 mm (mini module)
Transmitter frequency	33 kHz
Power supply	Li-Ion battery 18 V / 4 Ah
	Main adaptor 110–230 V, 50–60 Hz (optional)

**Wi-Fi transmitter**

Simple data transmission to mobile device

**Removable display unit with 10.4" color-touchscreen**

Full functionality, even in confined spaces

**Integrated speakers**

Direct audio replay

**Li-Ion battery 18 V / 4.0 Ah (same as ROMAX 4000)**

Long battery operation time (up to 6 hours)

**Digital metre count**

Precise determination of distance to camera head

**Integrated microphone**

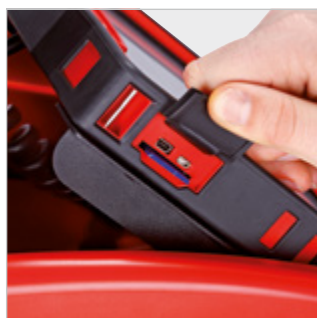
Voice recording for documentation possible

**Exchangeable reel system 65 m / 30 m / 16 m**

Large operating range from Ø 40–300 mm pipe diameter



Cover protected connections for SD card, Micro-HDMI and Mini-USB



Locating with ROSCOPE module ROLOC PLUS



Set (No. 1500002613) includes: ROCAM 4 PLUS, 30 m cable, Ø 30 mm camera head, guidance ball, accessory bag including location transmitter, USB-cable, pencil, RO BP18/4, 4.0 Ah 18V battery, RO BC14/36 charger, ROCASE 4414

Model	Weight	PU	No.
ROCAM 4 PLUS 30 m cable, 30 mm camera head, EU	18.500 kg	1	1500002613
ROCAM 4 PLUS 30 m cable, 40 mm camera head, EU	18.500 kg	1	1500002614
ROCAM 4 PLUS 30 m cable, 40 mm camera head, mini module	19.500 kg	1	1000001938



## ROCAM 4 PLUS 65 meter

Inspection camera for pipes from Ø 40–300 mm with 65 m cable length, with integrated software for documentation and large removable 10.4" touchscreen



### Modular reel system

Upgrade your ROCAM 4 PLUS from 30 m to 65 m at a later date



### Transport trolley with extendible handle

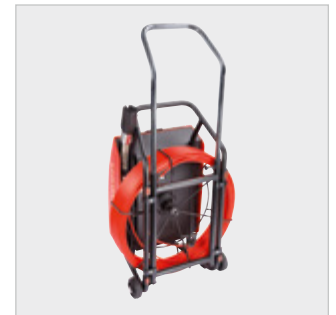
Comfortable transport over long distance

Set (No. 1500002615) includes: ROCAM 4 PLUS, 65 m cable, Ø 30 mm camera head, guidance ball, accessory bag including location transmitter, USB-cable, pencil, RO BP18/4, 4.0 Ah 18 V battery, RO BC14/36 charger, RO CASE 4414

Part of the CAS battery platform



Transport trolley with extendible handle



Model	Weight	PU	No.
ROCAM 4 PLUS 65 m cable, 30 mm camera head, EU	23.500 kg	1	1500002615
ROCAM 4 PLUS 65 m cable, 40 mm camera head, EU	23.500 kg	1	1500002616
ROCAM 4 PLUS 65 m cable, 40 mm camera head, mini module	24.500 kg	1	1000002481

## Extension modules

Easy extension of the working range from Ø 40–300 mm by quick change of the reel

### Application Benefits

- Professional inspection of small pipe diameters
- Easy handling due to Exchange reel system
- Subsequent extension of the range to 65 m possible

### Technical Data

Working area	Ø 40–100 mm
Camera head	Ø 25 mm
Cable diameter	5.5 mm

Model	Weight	PU	No.
Mini module, 16 m cable	1.314 kg	1	1500003296
Reel basket 65 m for ROCAM 4 PLUS	6.850 kg	1	1500002892



**ROCAM camera heads**

Camera heads made of high-quality materials for professional inspection of pipes from Ø 70–300 mm



**Application Benefits**

**Excellent brightness**

- The ROCAM camera head Ø 30 mm has over 10 ultra bright LED lights, that effortlessly illuminate pipes up to Ø 150 mm
- The camera head can be mounted with a Ø 40 mm camera head for larger pipe diameters

**Pressure tight screw slip-ring connection**

- Pressure tight connection (3 bar) between camera head and push cable
- High resistance to shock and impact
- Quick and toolless exchange of the camera heads
- No burden from electrical connections

**High flexibility and resistant**

- Flexible spring provides 90° curveability in pipes up to Ø 70 mm when enough stability is provided
- Pressure tight up to 3 bar with the stainless steel casing
- Scratch and impact resistant with the sapphire glass objective

**Application Benefits**

**Mountable transmitter**

- Optional 33 kHz transmitter can be used to determine the length of the camera head (90° from Ø 70 mm)
- In small pipe diameters the transmitter can also be used without the camera head to determine the course of the pipe without a visual inspection

**Technical Data**

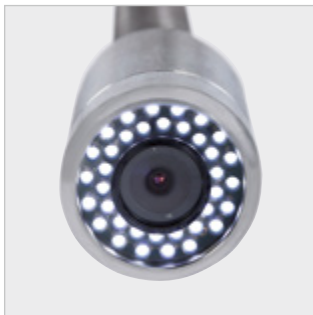
Camera head	Ø 30 mm with 10 LED lights Ø 40 mm with 36 LED lights self-leveling and waterproof
Brightness	175 lx (0.5 m), camera head Ø 30 mm 666 lx (0.5 m), camera head Ø 40 mm

**Automatic self-levelling**

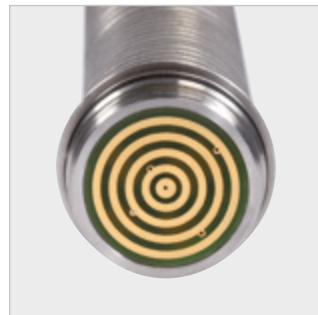


10

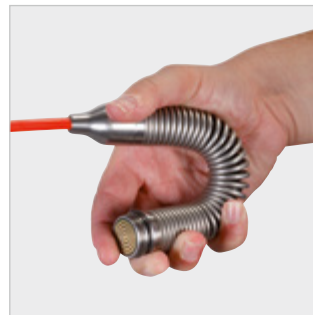
Excellent illumination



Pressure tight screw slip-ring connection



High flexibility and durability



Mountable transmitter



Model	Weight	PU	No.
Camera head Ø 30 mm	0.190 kg	1	1500000123

Model	Weight	PU	No.
Camera head Ø 40 mm	0.410 kg	1	1500000122

### Rolling skids

#### Recommended for distances from 10 m

Rolling skids RS40/150 for pipes Ø 150–200 mm  
 Rolling skids RS40/200 for pipes Ø 200–300 mm

#### Application Benefits

- Optimized view of the pipe section
- Less pushing resistance with the fully rubberized wheels



No. 69118

No. 69119

For camera head Ø 30 mm	Weight	PU	No.
Adapter Ø 30 to Ø 40mm	0.100 kg	1	1000001836

For camera heads Ø 40 mm	Weight	PU	No.
Rolling skids Ø 150 mm	0.700 kg	1	69118
Rolling skids Ø 200 mm	0.700 kg	1	69119

### Guidance balls

#### For centring of the camera head in pipes for a better overview and illumination

Guidance ball for pipes Ø 70–150 mm  
 Guidance ball with brush attachment for pipes Ø 70–200 mm

#### Application Benefits

- Optimized view of the pipe section through centring in the pipe
- Dirt will not accumulate in front of the lens



No. 69112/1500000817

No. 69111/1500000120

For camera heads Ø 30 mm	Weight	PU	No.
Guidance ball for Ø 150 mm	0.200 kg	1	1500000120
Guidance ball for brush attachments	0.200 kg	1	1500000817

For camera heads Ø 40 mm	Weight	PU	No.
Guidance ball for Ø 200 mm	0.200 kg	1	69111
Guidance ball for brush attachments	0.200 kg	1	69112

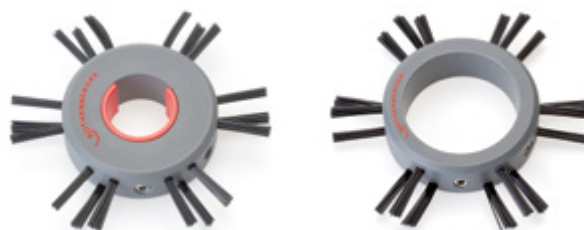
### Brush attachments

#### For centering the camera head and for improving sight in pipes from Ø 100–200 mm

Brush attachment Ø 100 for use in pipe Ø 100–150 mm  
 Brush attachment Ø 150 for use in pipe Ø 150–200 mm

#### Application Benefits

- Optimized view of the pipe section through centring in the pipe
- Dirt will not accumulate in front of the lens
- Good curveability with the brush flexibility



Brush attachment spiral feather (rear) No. 69113    Brush attachment camera head (front) No. 69113

Model	Weight	PU	No.
Brush attachment Ø 100 mm <sup>1</sup>	0.200 kg	1	69113

Model	Weight	PU	No.
Brush attachment Ø 150 mm <sup>1</sup>	0.300 kg	1	69117

1) Use with guidance ball No. 69112/1500000817







## Flushing and pipe cleaning








<b>System overview</b>	238-239
<b>Flushing</b>	
Flushing compressors	240-242
Cleaning chemicals	242
<b>Decalcifying</b>	
Decalcifying pumps	243
Decalcifying chemicals	246
<b>Filling</b>	
Solar filling pump	247
<b>Pipe cleaning manual</b>	
Manual pipe and drain cleaning devices	248-250
<b>Pipe cleaning electric</b>	
Manual pipe and drain cleaning machines (electric)	251
Sectional drain cleaning machines	252-254
Drum drain cleaning machines	255-257
Accessories pipe cleaning electric	258-261
<b>Drain cleaning spirals</b>	
Spirals	262-263
<b>Drain cleaning tools</b>	
Heads and augers	264-268
Tool and spiral sets	269-271
Accessories drain cleaning spirals	271
<b>High pressure drain cleaning</b>	
System overview high pressure drain cleaners	273
High pressure drain cleaners	273






**Flushing**




	ROPULS	ROPULS eDM
		
Connection	1"	1"
Max. pipe diameter	Ø 50 mm	Ø 50 mm
Max. water pressure	7 bar	7 bar
Documentation	○	●
<b>Page</b>	<b>240</b>	<b>241</b>






**Pipe cleaning**

	WC-BLITZ	ROPOWER HANDY	ROSPIMATIC CL	ROSPI 6 H+E Plus	ROSPI 8 H+E Plus
					
Operation mode	Manual	Manual	Electric	Manual / Electric	Manual / Electric
Working range	Ø 50–100 mm	Ø 50–100 mm	Ø 20–50 mm	Ø 20–50 mm	Ø 20–50 mm
Max. spiral length	1 m	2.3 m	7.5 m	4.5 m	7.5 m
Spiral diameter	13 mm	16 mm	8 mm	6 mm	8 mm
Power	○	○	○	○	○
<b>Page</b>	<b>250</b>	<b>250</b>	<b>251</b>	<b>249</b>	<b>249</b>

11

	RODRUM M 13	RODRUM M 16	RODRUM L 16	RODRUM L 20	R 550
					
Operation mode	Electric	Electric	Electric	Electric	Electric
Working range	Ø 70–100 mm	Ø 70–125 mm	Ø 70–125 mm	Ø 125–250 mm	Ø 20–100 mm
Max. spiral length	30 m	45 m	45 m	60 m	40 m
Spiral diameter	13 mm	16 mm	16 mm	20 mm	16 mm
Power	620 W	620 W	620 W	620 W	440 W
<b>Page</b>	<b>257</b>	<b>257</b>	<b>257</b>	<b>257</b>	<b>252</b>

Decalcifying			Demineralization			
	ROCAL 20	ROMATIC 20	Cartridge PURE H <sub>2</sub> O			
						
Tank volume	15 l	15 l	Dimension	S	M	L
Volume flow	40 l/min	40 l/min	Weight	1,5 kg	2,8 kg	5,1 kg
Delivery height	10 m	10 m	Connection	3/4"	3/4"	3/4"
Motor rating	150 W	150 W	Max. temperature	60 °C	60 °C	60 °C
Max. temperature	50 °C	50 °C	Max. pressure	4 bar	4 bar	4 bar
Flow reversal	Manual	Automatic	Max. water quantity	5 l/min	10 l/min	10 l/min
<b>Page</b>	<b>243</b>	<b>243</b>	<b>Page</b>	<b>244</b>		

Pipe cleaning					
	ROSPI 10 H+E Plus	Manual drain cleaner 3 S	RODRUM S 10	RODRUM S 13	RODRUM VarioClean
					
Operation mode	Manual / Electric	Manual	Electric	Electric	Electric
Working range	Ø 20–70 mm	Ø 50–100 mm	Ø 40–70 mm	Ø 50–100 mm	Ø 40–100 mm
Max. spiral length	10 m	15 m	10 m	15 m	10 m* / 15 m
Spiral diameter	10 mm	13 mm	10 mm	13 mm	10 mm* / 13 mm
Power	○	○	440 W	440 W	Battery
<b>Page</b>	<b>249</b>	<b>250</b>	<b>255</b>	<b>255</b>	<b>256</b>

	R 600	R 600 VarioClean	R 650	R 750
				
Operation mode	Electric	Electric	Electric	Electric
Working range	Ø 20–150 mm	Ø 20–150 mm	Ø 20–150 mm	Ø 50–200 mm
Max. spiral length	60 m	60 m	65 m	80 m
Spiral diameter	8 <sup>1</sup> / 10 <sup>1</sup> / 16 / 22 mm	8 <sup>1</sup> / 10 <sup>1</sup> / 16 / 22 mm	8 <sup>1</sup> / 10 <sup>1</sup> / 16 / 22 mm	16 <sup>1</sup> / 22 / 32 mm
Power	690 W	Battery	1,350 W	1,400 W
<b>Page</b>	<b>252</b>	<b>253</b>	<b>254</b>	<b>254</b>

1) Only usable with collet, clamping jaws or adaptor magazine (see page 259)  
 \* With additionally available Accessories

## ROPULS eDM Flushing Compressor

For scouring and cleaning of heating systems and flushing of drinking water pipes according to DIN 1988-2 / EN 806 with protocol function



Flushing compressor for desludging and cleaning heating systems and drinking water pipes

### Application Benefits

- **One unit—three uses** for safety and energy efficiency:
  - Flushing of floor heating systems / heating circuits
  - Flushing of drinking water pipes as per DIN 1988-2/EN 806
  - Sanitizing of drinking water pipes
- Compact dimensions and practical carriage for simple handling during transport and at the building site
- Two flushing speeds (impulse and permanent air flushing) for good cleaning results
- Easy to use with the clearly arranged control panel
- Chemical cleaning with ROCLEAN accessories possible
- Free app for easy, professional creation of flushing-protocols as PDF file

### Technical Data

Input power	1.5 kW
Frequency	50 Hz
Voltage	230 V
Particle retention rate	0,3 µm Compressor
Max. water pressure	7 bar
Water temperature	0–30 °C
Max. operating pressure	8 bar
Oil separation rate	99.9%
Flow rate	0.006–5 m³/h

Large LED display for flow rate amounts and metering impulse, membrane keyboard with program selection keys

Clearly arranged control pane

Quick connect NW 7.2

For connecting pneumatic tools

Function switch

Enables you to change to ROCLEAN function

ROPULS eDM App with documentation feature



ROPULS eDM with ROCLEAN function for cleaning and conservation



For removing deposits in floor heating and radiators

Clean heating systems save energy

Pre-commission cleaning of construction material and residues

Clean, proper hygienic pipe systems

Flushing of drinking water pipes with pulsing compressed air water mix as per DIN 1988-2/EN 806

Safety for plumbers and plant operator

ROPULS eDM documentation

- ✓ Easy
- ✓ Fast
- ✓ Professional

**ROCLEAN function, optional available for ROPULS eDM and ROPULS Flushing compressor!**

Scope of delivery (No. 1000001134): ROPULS eDM flushing compressor, 2 × 1 m fabric hose 1" with GK coupling

Model	Weight	PU	No.
ROPULS eDM flushing compressor with hoses	28.000 kg	1	1000001134



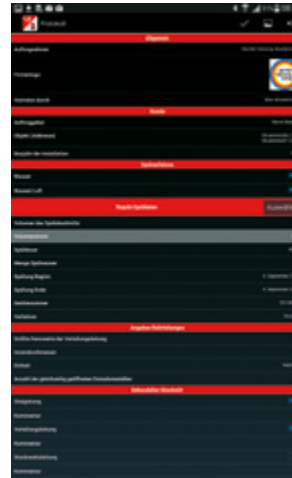
## ROPULS eDM App

Professional working and documentation due to eDM (electronic Data Management)



### Application Benefits

- Report can be e-mailed immediately as a PDF
- Transfer of flushing data via Bluetooth
- Applicable for Android and Windows devices
- Easy, fast, professional documentation
- Company profiles and protocols individually customizable
- Live data transfer to handheld unit
- Templates for various flushings-protocols available



## ROPULS Flushing compressor

With the same range of functionality as ROPULS eDM, but without eDM (electronic Data Management)



### Function switch

Enables you to change to ROCLEAN function

Scope of delivery (No. 1000000145): ROPULS flushing compressor, 2 x 1 m fabric hose 1" with GK coupling

Model	Weight	PU	No.
ROPULS flushing compressor with hoses	28.000 kg	1	1000000145

For removing deposits in floor heating and radiators

Clean heating systems save energy

Pre-commission cleaning of construction material and residues

Clean, proper hygienic pipe systems

Flushing of drinking water pipes with pulsing compressed air water mix as per DIN 1988-2/ EN 806

Safety for plumbers and plant operators

**ROCLEAN function, optional available for ROPULS eDM and ROPULS Flushing compressor!**

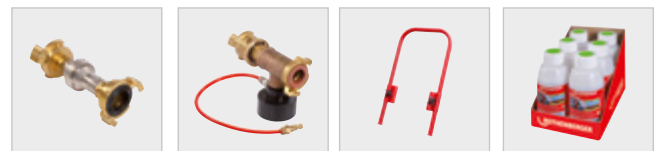


### Accessories

### No.

ROCLEAN Injector	1000000190
Pressure regulator 2 bar	1500000203
ROPULS extension handle	1500003517

**ROCLEAN cleaning and conservation on page 242**



**ROCLEAN function**

For cleaning and conserving radiator heating systems, surface heating systems as well as for disinfection of drinking water lines

**1** The **pressure reducer** has to be installed on the water input side of the ROPULS flushing compressor. This maintains the incoming pressure of the fresh water feed constant at 2 bar.

**2** The **ROCLEAN injector** has to be installed on the water output side. The injector constantly and securely doses the bottle contents to the system to be cleaned.



**Cleaning and preservation with ROCLEAN**

**Cleaning chemicals for radiator heating systems**



For cleaning incrustations and tough deposits. Suitable for all standard pipe materials. Does not stay in system. One bottle per 100l system volume.



**Cleaning chemicals for surface heating systems**



For cleaning of deposits and bio films. Suitable for all standard pipe materials. Does not stay in system. One bottle per 100l system volume.



**Preservative for radiators and surface heating systems**



Maintains the cleaned condition and protects the system. One bottle is sufficient for 100l system volume.



**Disinfection of drinking water systems**

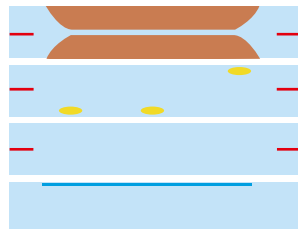


Does not stay in system. One bottle per 100l system volume.



**Cleaning and preservation steps:**

<b>Before cleaning</b>
<b>Step 1:</b> Mechanical cleaning
<b>Step 2:</b> Chemical cleaning
<b>Step 3:</b> Preserving



Model	Color code	Weight	PU	No.
Chemical cleaning:				
Radiator heating systems	Orange	6.300 kg	1	1500000200
Surface heating systems	Green	6.300 kg	1	1500000201
Preservative	Blue	6.300 kg	1	1500000202
Disinfection	Yellow	6.300 kg	1	1500000157

## ROCAL 20 / ROMATIC 20

### Decalcifying pump with flow direction change

For the quick decalcifying of heat exchangers, water pipes, water tanks, heat and cooling systems

#### Application Benefits

- With the help of the flow reversal (change of the direction of flow) even very hard calcifications and deposits can be loosened
- Approved for fluid temperatures up to 50 °C for especially efficient decalcifying
- Constant circulation of the decalcifying chemical prevents damage that can be caused by the development of gas during decalcification



#### Technical Data

Frequency	50 Hz
Voltage	220–240 V
Working area Temperature	0–50 °C
Connection	R 1/2"
Volume flow	40 l/min
Tank volume	15 l
Pump head	10 m

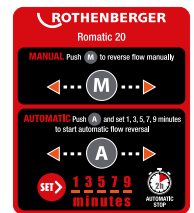


Fig. ROCAL 20

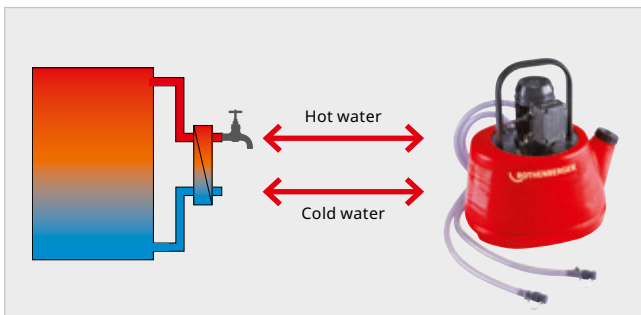


Fig. ROMATIC 20

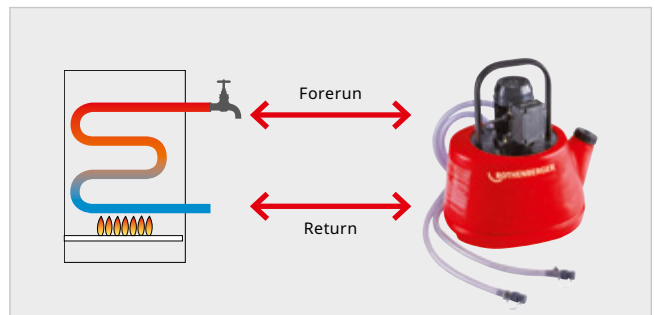
**Automatic flow reversal!**



Decalcifying of fresh water stations and external heat exchangers



Decalcifying of heat exchangers, water heaters or drinking water pipes



Scope of delivery: ROCAL 20 (No. 61100) and ROMATIC 20 (No. 61190) each contain: 2 × hoses with 1/2" connection (2 m long), 2 × double nipple 1/2–3/8", 2 × double nipple 1/2–3/4", 2 × double nipple 1/2–1/2", 2 × double socket 3/4–3/4", 2 × reduction piece 1/2–3/4"

Scope of delivery: ROCAL 20 set (No. 19207): ROCAL 20 (No. 61100), ROCAL Acid Plus 5 kg (No. 61105), Neutraliser powder 1 kg (No. 61115)

Model	Weight	PU	No.
ROCAL 20	8.300 kg	1	61100
ROMATIC 20	8.500 kg	1	61190
ROCAL 20 set	11.000 kg	1	19207

#### Accessories

Decalcifying chemical for ROCAL 20, ROMATIC 20 see page 246

### Demineralization cartridge PURE H<sub>2</sub>O

**Demineralization cartridge. Tested 2-component mixed bed resin for reliable full demineralization of the heating water according to VDI 2035**

With the new PURE H<sub>2</sub>O demineralization cartridges from ROTHENBERGER, standard-compliant filling of heating systems in accordance with VDI 2035 is quick and uncomplicated. Installers can use the cartridges during new installations and servicing to remove harmful minerals from the filling water.

### Application Benefits

- Easy and standard approved filling of any heating system with required technical water
- „Plug and Play“ system of the cartridge regulates all relevant parameters to fill the system according to the standards for easy installation
- No additional devices are needed to monitor the sufficient quality of technical water during filling
- Current consumption of the cartridge is displayed with the help of the high quality color change ion-exchange resin



#### „Plug & Play“ system

Cartridge regulates all relevant parameters to fill the system with technical water according to the standards

#### Use of high quality color change resin

The resin changes its color and indicates to the craftsman when it is used up.

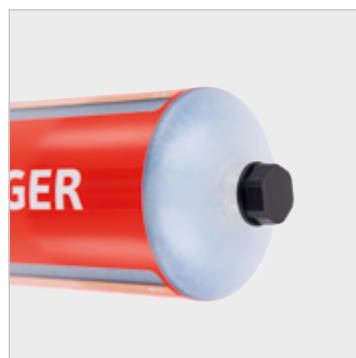
#### Different sizes of cartridges available

Every system is different and requires different amounts of water. ROTHENBERGER has solutions for all these requirements

11



Easy monitoring of the process without additional tools



Screw cap for easy opening and installation



Available in sizes S / M / L and as a set in size S incl. wall bracket and filling hose



Filling heating systems according to standards



Quick and easy installation "Plug and Play" system



Set in size S with wall bracket and filling hose for the right station for demineralized water

## Technical Data

	Small (S)	Medium (M)	Large (L)
Dimension	450 × 80 × 80 mm	450 × 80 × 80 mm	770 × 110 × 110 mm
Weight	1.5 kg	2.8 kg	5.1 kg
Connection	3/4" on both sides	3/4" on both sides	3/4" on both sides
Max. water temperature	60 °C (short term)	60 °C (short term)	60 °C (short term)
Max. pressure	4 bar (short term)	4 bar (short term)	4 bar (short term)
Max. water quantity	5 l/min	10 l/min	10 l/min
Capacity at 1°GH <sup>1</sup>	2.000 l	4.000 l	7.000 l
Capacity at 14°GH <sup>1</sup>	140 l	280 l	500 l

Model	Weight	PU	No.
PURE H2O (S) demineralization cartridge	1.800 kg	1	1500004290
PURE H2O (M) demineralization cartridge	3.000 kg	1	1500004322
PURE H2O (L) demineralization cartridge	6.200 kg	1	1500004325
PURE H2O S-TATION Wall-mounted station set	2.500 kg	1	1500004350

1) GH = German hardness

## ROCAL Acid Multi

### Decalcifying chemical for use with ROCAL 20, ROMATIC 20

ROCAL Acid Multi For the safe decalcification of all piping systems, heat exchangers, fresh water stations and water tanks

#### Application Benefits

- With color indication. The use of the chemical effects is shown by the change of the fluid color
- Concentrate to mix with water
- With corrosion protection



No. 1500000115

No. 1500000116

No. 1500000117



No. 61105

No. 61106

No. 1500000914

	ROCAL Acid Multi	ROCAL Acid Plus
Copper	●	●
Steel	●	●
Stainless steel	●	○

● suitable ○ unsuitable

	ROCAL Acid Multi	ROCAL Acid Plus
Aluminium	●	○
Brass	●	○
Plastic	●	○

● suitable ○ unsuitable

Model	Weight	PU	No.
ROCAL Acid Multi	30.000 kg	1	1500000117
ROCAL Acid Multi	10.000 kg	1	1500000116
ROCAL Acid Multi	5.000 kg	1	1500000115

Model	Weight	PU	No.
ROCAL Acid Plus	25.000 kg	1	1500000914
ROCAL Acid Plus	10.000 kg	1	61106
ROCAL Acid Plus	5.000 kg	1	61105

11

## Neutralization powder

### Neutralizes ROCAL Acid Plus / ROCAL Acid Multi

Use is necessary after ROCAL Acid Plus / ROCAL Acid Multi has been used. The neutralizer dissolves in water. The decalcification pump and system are flushed with this solution. The PH value in the system and pump is neutral afterwards

Model	Weight	PU	No.
Neutralizer powder	1.000 kg	1	61115
Neutralizer powder	10.000 kg	1	61120



## ROSOLAR PUMP / ROSOLAR PUMP PLUS

### Solar filling pump

For filling and flushing solar systems



#### Application Benefits

- A powerful centrifugal pump for rapid filling and effective flushing out and ventilation of solar plant
- Optional: robust and heat resistant (up to 90 °C) Impeller pump: Small particles of solid materials are also conveyed without difficulty. Fitted with a pressure relief valve
- Heat resistant hoses (up to 100 °C) allow safe filling and maintenance of solar plant
- A height-adjustable (76–110 cm) telescopic grip for space-saving storage, simple transport and good handling in tight cellars
- Well thought-through handling: The canister can easily be filled through the large opening. The shut-off valve in the bottom allows simple/uncomplicated emptying of the whole container
- Ball valves for safe removal of filling hoses without accidental spill

#### Technical Data

Connection	3/4"
Tank volume	30 l

Return flow cover with filter



Hose connection with anti-kink protection



Ball valve



#### A generously dimensioned container opening

For easy and secure filling

#### Optional: A fleece filter bag

For preservation of the internal filter when flushing older plants with strong pollution

#### A dirt filter with sight glass

Filters residues out of the medium



#### Height-adjustable telescopic grip (76–110 cm)

Small and flexible if required

#### Heat resistant hoses (up to 100 °C)

Safe working—also when servicing solar plant with kink protection at the hose connection

#### Optional: impeller pump

Small particles of solid materials are also conveyed without difficulty

Model	Weight	PU	No.
ROSOLAR PUMP PLUS with impeller pump	21.800 kg	1	1500000136
ROSOLAR PUMP with centrifugal pump	23.300 kg	1	1500000135
ROSOLAR fleece filter bag 10 pieces	0.150 kg	1	1500001236
Return flow cover for filter bag	0.220 kg	1	1500001235

Scope of delivery: ROSOLAR Pump 2 × 3 m hose with 3/4" connection, fleece filter bag, return flow cover, operation manual

**ROPUMP SUPER PLUS**

**Professional force pump cleaner**

The optimum introduction tool for the removal of obstructions in basins, bowls, tubs and toilets etc., using water pressure

**Application Benefits**

- Optimal adaption to the job due to adjustable handle
- Good force transmission with ergonomic handles
- Optimal sealed system and therefore high suction and pressure power with single cast main body
- Simple handling with the perfect adaption to the drain and easy to use with ergonomic formed components

**Quick—Compact—Handy!**

Short adaptor



Long adaptor



Adaptor short No. 72072

**Ergonomic D-handle**  
Perfect transmission of force and optimal handling

**Short and long adaptor included in scope of delivery!**

Adaptor long No. 72071



Adaptor wide No. 72073



Model	Weight	PU	No.
ROPUMP SUPER PLUS with 2 Adaptors long, short	2.330 kg	1	072070X
ROPUMP SUPER PLUS with 3 Adaptors long, short, wide, tool bag	2.920 kg	1	1000001762
ROPUMP SUPER PLUS Adaptor wide, ROBUCKET	5.500 kg	1	1000002823
Adaptor wide, for ROPUMP SUPER PLUS	0.400 kg	1	72073
Adaptor short, for ROPUMP SUPER PLUS	0.160 kg	1	72072
Adaptor long, for ROPUMP SUPER PLUS	0.660 kg	1	72071

11

**ROPUMP**

**Force pump cleaner according to the airpump principle with water pressure Dissolves obstructions in drains, basins, showers, bathtubs etc.**

For removing light blockages in connecting pipes of washbasins, showers or bathtubs

**Application Benefits**

- Small and handy
- Compact and effective



**Flexible socket**

Various areas of application

Model	Weight	PU	No.
ROPUMP with flexible socket	0.500 kg	1	71991



## ROSPI H+E Plus

### Professional manual and electrical drain cleaning unit

Clean and comfortable removal of obstructions in kitchen, bath, toilets or drainage openings with drain cleaning spiral

#### Application Benefits

- Removal of sinks and siphons is not necessary
- Switch from manual to electrical use within seconds
- Secure hold even at higher speeds during drill operation
- Impact-resistant and protected from dirt contamination
- Hexagonal drive for conventional power drills

#### Technical Data

Spiral diameter	6/8/10 mm
Working area diameter	3/4-2"
Working area diameter	20-75 mm
Working area Length	7,5 m

#### Ergonomic handle with soft grip inlay

Safe grip and operation even at high speed

#### Spiral lock with flexible spiral and incorporated bulb head auger

Removes dirt in hard-to-reach spaces

#### Closed plastic spiral container

Clean use and sturdy construction

#### Hexagonal bolt

For conventional power drills

#### Knurled screw, change without tools

Switch from manual to electrical use within seconds



Electrical operation with cordless drill



Manual operation



Model	Weight	PU	No.
ROSPI 6 H+E PLUS 4.5 m	1.400 kg	1	72090
ROSPI 8 H+E PLUS 7.5 m	3.500 kg	1	72095
ROSPI 10 H+E PLUS 10 m	4.800 kg	1	72005

For spare spirals see page 271

## Flushing and pipe cleaning

### Pipe clearing devices

#### ROPOWER HANDY

##### Manual drain cleaning unit, Ø 50–100 mm

An universal manual drain cleaning unit for fast clearance of obstructions. The spiral permits the attachment of a wide range of ROTHENBERGER pipe cleaning tools with 16 mm couplings

##### Application Benefits

- Additional spiral cleaning effects with the use of a square spiral



Set (No. 71973) includes: ROPOWER PROFILE spiral 2.3 m without core (No. 72494), manual crank (No. 71976), safety gloves (No. H81401), separating pin (No. 72100), blade cutter Ø 25 mm (No. 72169)

Model	Weight	PU	No.
ROPOWER HANDY complete	1.700 kg	1	71975

Accessories	Weight	PU	No.
Manual crank	0.400 kg	1	71976
ROPOWER PROFILE CABLE	1.200 kg	1	72494

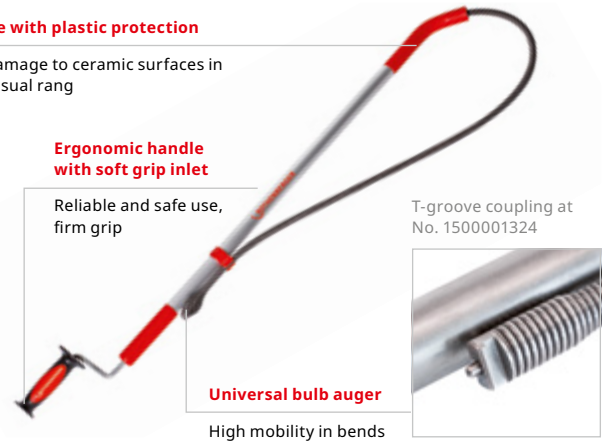
#### WC-BLITZ RO 3 Toilet Cleaner

##### Application Benefits

- Flexible use even in hard-to-reach places
- With tough cleaning bulb auger. Extendable handle and 1 m spiral length, 1/2"
- No damage to ceramic surfaces Angle made out of plastic

##### Angle with plastic protection

No damage to ceramic surfaces in the visual rang



Model	Weight	PU	No.
WC-Blitz RO-3 with bulb auger	2.750 kg	1	78551
WC-Blitz RO-3 with tool-coupling	2.900 kg	1	1500001324

#### Manual drain cleaner type 3 S

##### For pipes Ø 40–100 mm

##### Spirals Ø 13 mm × 15 m with 16 mm coupling

##### Application Benefits

- **Flexible use with a wide range of applications**  
For use with all ROTHENBERGER drain cleaning tools with 16 mm couplings
- **Cleaning unit with stand**  
Secure use
- **Plastic spiral drum**  
Corrosion-proof and impact-resistant



Set includes (No. 72003): Manual drain cleaner type 3 S (No. 72003), spirals Ø 13 mm × 15 m (No. 72016), cross-blade cutter Ø 35 mm (No. 72176) and separating pin (No. 72100)

Model	Weight	PU	No.
Manual drain cleaner 3 S, complete	17.500 kg	1	72003



## ROSPIMATIC CL

### Professional drain cleaning unit up to Ø 50 mm

Effective removal of obstructions in access lines with a one-of-a-kind spiral forward and reverse system without changing the rotational direction

#### Application Benefits

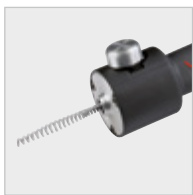
- Switch between forward and reverse under full load without the need to change the motor rotational direction
- Unit can be used with any professional cordless drill driver
- Soft stop technology for smooth run out prevents hits to user's wrist
- The spiral drive can be combined with 3 different cleaning tools for more efficient operation (optional)
- Optional guide hose prevents pollution of the working place

#### Technical Data

Spiral diameter	8 mm
Working area diameter	20–50 mm
Working area Length	7.5 m



With bulb-auger



With coupling for various tools



With flexible guide hose



Easy connection to professional cordless drill driver



Set (No. 100002299) includes: ROSPIMATIC CL set incl. spiral 8 mm × 7.5 m with bulb head (No. 72413), spiral 8 mm × 7.5 m with coupling (No. 72425), cross-blade auger (No. 72765) and separating key (No. 72102)

Set (No. 72942) includes: blade cutter (No. 72764), cross-blade cutter (No. 72765), ball head cutter (No. 72766), separating pin (No. 72102)

#### Model

Model	Weight	PU	No.
ROSPIMATIC CL spiral 8 mm, bulb auger	3.900 kg	1	100002298
ROSPIMATIC CL set spiral, cross-blade-auger	6.200 kg	1	100002299
Spiral 8 mm, wire 2 mm, length 7.5 m, type C1-IC, with core, with bulb auger, for ROSPI 8	2.160 kg	1	72413
Spiral 8 mm / 7.5 m with coupling and core	2.200 kg	1	72425
Tool set 8 mm, 4 pieces	0.100 kg	1	72942

**R 550**

**Drain cleaning machine for pipe Ø 20–100 mm**

Reliable, high-performance drain cleaning machine with a variety of general purpose maintenance uses

Especially light, compact and handy design: Ideal for the universal service use by pipe obstructions in connecting pipes from wash basins, toilets, sewage pipes, floor drains and roof drainage



**Application Benefits**

- Extremely light
- Direct attachment of 16 mm spirals
- Maximum working length 40 m, with Ø 16 mm S-spiral

**Technical Data**

Input power	440 W
Frequency	50 Hz
Voltage	230 V
Spiral diameter	16 mm
Working area diameter	20–100 mm
Working area Length	40 m
Speed	583 U / min

Model	Weight	PU	No.
R 550 with guide hose	16.000 kg	1	72686
R 550 with spiral & tool set, 16 mm	25.000 kg	1	079890X

**Tool sets starting on page 269**

**R 600**

**Drain cleaning machine for pipe Ø 20–150 mm**

For installation and maintenance work in hospitals and municipal facilities

Universal use both indoors and outdoors: The powerful motor works reliably even against stubborn obstructions. A wide range of accessories is available



**Application Benefits**

- Direct up take of 16 mm and 22 mm spirals
- Optional Ø 8 and 10 mm with adaptor magazine possible
- Maximum working length 50 m with Ø 16 mm S-spirals
- Maximum working length 60 m with Ø 22 mm S-spirals

**Technical Data**

Input power	690 W
Frequency	50 Hz
Voltage	230 V
Spiral diameter	8–22 mm
Working area diameter	20–150 mm
Working area Length	60 m
Speed	467 U / min

Model	Weight	PU	No.
R 600 with guide hose	20.900 kg	1	72687
R 600 with guide hose, UK	23.500 kg	1	72869

**Tool sets starting on page 269**

## R 600 VarioClean

### Drain cleaning machine for pipe Ø 20–150 mm

For working in service areas, hospitals and non-municipal facilities, especially in areas without power supply.

Ideal for plumbers, janitors and pipe cleaners for the effective and flexible removal of blockages in sewage pipes up to 150 mm in diameter. Particularly suitable for use in areas without power supply.

#### Application Benefits

- CAS-battery / AMPShare-battery system: For wireless working and increased electrical safety
- VarioClean Electronic: Three speed levels for unblocking, cleaning and clean spinning. Optimal adaptation possibilities to the type of blockage
- Suitable for indoor and outdoor use
- Compact design and low weight

Available in the manufacturer-independent battery systems AMPShare – Powered by Bosch or CAS – CORDLESS ALLIANCE SYSTEM



#### Technical Data

Voltage	230 V
Spiral diameter	8–22 mm
Working area diameter	4/5–6"
Working area diameter	20–150 mm
Working area Length	60 m
Battery number	1 Piece
Battery system	Rechargeable
System battery	CAS or AMPShare
Type battery	Li-HD or ProCORE
Capacity battery	8 Ah
VarioClean speed levels	427 / 527 / 614 rpm



#### VarioClean-Electronic

Optimum adaptation to the type of blockage for faster work progress

#### LED site light

Perfect illumination of the work area

#### Versatile application

70 tools with 5 different types of spirals

#### Spiral holder / Spiral separator

Safe insert and separation of new spiral segments

#### Multigrip Center-Lock clamping system

For spiral sizes 16 and 22 mm. Automatic adaption to all sizes

#### Multiple battery systems

Suitable for AMPShare or CAS battery systems

#### Brushless Motor

For wear-free work and longer machine life

Model	Weight	PU	AMPShare-No.	CAS-No.
R 600 VarioClean baretool	13.000 kg	1	1000004138	1000003345
R 600 VarioClean with DuraFlex SMK spirals 16–22 mm, 8 Ah battery, charger	50.700 kg	1	1000004139	1000003346
R 600 VarioClean with 8 Ah battery, charger	18.700 kg	1		1000003372

For spare spirals see page 271

**R 650**

**Drain cleaning machine for pipe Ø 20–150 mm**

For professional mobile drain cleaning. Compact, robust and powerful, even by the toughest pipe obstructions

Perfectly suited for rough use and in extreme working conditions: Quiet operation and powerful cleaning action, even when cutting through roots or grinding out cement and lime deposits



**Application Benefits**

- Double motor performance (cp. R 600)
- Flexible with drive lever that can be fitted on the side
- Direct up take of 22 mm and 16 mm spirals
- Optional Ø 8 and 10 mm with adaptor magazine possible
- Maximum working length 65 m, with Ø 22 mm S-spiral

**Technical Data**

Input power	1,350 W
Frequency	50 Hz
Voltage	230 V
Spiral diameter	8–22 mm
Working area diameter	20–150 mm
Working area Length	65 m
Speed	623 rpm



Model	Weight	PU	No.
R 650 inclusive tool set, EU	51.500 kg	1	72680
R 650 with guide hose	22.800 kg	1	72688

**Tool sets starting on page 269**

**R 750**

**Drain cleaning machine for pipe Ø 20–200 mm**

For professional mobile drain cleaning. Compact, robust and powerful, even by the toughest pipe obstructions

Perfectly suited for the cleaning of domestic connections and main pipes: Quiet operation and powerful cleaning action. Usable for such as chain spinning, grinding and cutting roots



**Application Benefits**

- Drive lever can be rotated (180°), locked and used as a handle for easy wheeling
- Direct up take of 32 mm and 22 mm
- Optional Ø 16 mm with clutch jaw possible
- Maximum working length 80 m, with Ø 32 mm S-spirals

**Technical Data**

Input power	1,400 W
Voltage	230 V
Spiral diameter	16–32 mm
Working area diameter	20–200 mm
Working area Length	80 m
Speed	467 rpm



Model	Weight	PU	No.
R 750 with guide hose	33.500 kg	1	72689
R 750 without guide hose	33.500 kg	1	72910

**Tool sets starting on page 269**

## RODRUM S

**Drum drain cleaning machine with automatic spiral feed.**  
**For pipes from Ø 40–100 mm. Perfectly suited for use in public and commercial buildings**

- Compact construction: Ideal for service deployment to unblock pipes in connecting pipes of wash basins, toilets, drainage pipes, floor drainage
- On retraction the dirty spiral moves back into the spiral drum. Due to its clean and discrete operation, the machine is best suited for SHK-companies and their services in private houses, hospitals and clinics, gastronomy and hotels, facility Management and public buildings

### Interchangeable drum

Fast change between Ø 10 mm and 13 mm spirals, easy to carry



### Rubber feet

No damage to the floor

### Application Benefits

- Clean and discreet use
- Easy handling due to automatic spiral feeding and retrieving
- New feeding unit for direct pressure relief by release of the feeding handle
- Machine works with Ø 10 and 13 mm spirals
- **Flexible use:**  
Drum interchangeable for different pipe diameters
- **Easy to use:**  
Feeding and pressure relief with single handle
- **Clean:**  
Spiral in detachable drum

### Technical Data

Spiral diameter	10–13 mm
Working area diameter	40–100 mm

### Spiral protection

Fast tension relief from the spiral to prevent damage just by releasing the lever

### Cleanout slots and drain plug

Easy and fast cleaning of the drum

### 2-in-1 feeding unit

Suitable for Ø 10 mm and Ø 13 mm spirals

Model	Weight	PU	No.
RODRUM S 13 with tool set, EU	25.700 kg	1	1000001257
RODRUM S 10 EU	18.900 kg	1	1000001256
Spiral 13 mm × 15 m with reinforced wire	10.400 kg	1	72016

Accessories	Weight	PU	No.
RODRUM S 10 Drum	5.500 kg	1	1000001275
RODRUM S 13 Drum	11.400 kg	1	1000001276
Tool kit 16 mm	5.500 kg	1	1000001308

**Spirals, Drain cleaning tools on page 271**

Cleaning of floor drain with 13 mm spiral



**Set (No. 1000001256) includes:** RODRUM S 10, guide hose (No. 1300002581), spiral guide gloves (No. 1500000439)

**Set (No. 1000001257) includes:** RODRUM S 13, spiral guide gloves (No. 1500000439), chain spinning head (No. 072185F), cross blade cutter (No. 72176), forked cutter (No.72164), bulb auger (No. 72163), retrieving auger (No. 72162), straight auger (No.72161), separating pin (No.72100), guide hose (No.1300002581), ROCASE (No. 1300003334) with inlay (No. 1300003372)

**Set (No. 1000001308) includes:** chain spinning head (No. 072185F), cross blade cutter (No.72176), forked cutter (No.72164), bulb auger (No. 72163), retrieving auger (No. 72162), straight auger (No. 72161), separating pin (No.72100), ROCASE (No. 1300003334) with inlay (No. 1300003372)

**RODRUM VarioClean**

The RODRUM VarioClean is a compact drum machine for removing blockages in pipes from 40–100 mm diameter.

Through its clean and discrete work it is ideally suited for sanitary businesses, janitors, drain cleaners or for use in households, catering and hotels or public buildings because the dirty spiral moves into the drum during the return.

For the removal of blockages in sewage pipes of 40–100 mm in diameter. 10 mm spiral for pipe diameters from 40–70 mm  
13 mm spiral for pipe diameters from 50–100 mm

**Application Benefits**

- CAS-battery / AMPShare-battery system: For wireless working and increased electrical safety
- VarioClean Electronic: Three speed levels for unblocking, cleaning and clean spinning. Optimal adaptation possibilities to the type of blockage
- VarioClean Electronic: Prevents the drum from running on for a long time
- DuraFlex spirals: Especially flexible spirals with galvanisation. Optimized for the usage with the battery-powered RODRUM VarioClean



**Technical Data**

Voltage	230 V
Spiral diameter	10–13 mm
Working area diameter	40–100 mm (15–40")
Working area Length	15 m
Battery number	1 Piece
System battery	CAS or AMPShare
Type battery	Li-HD or ProCORE
Capacity battery	8 Ah
VarioClean speed levels	275 / 340 / 395 rpm

Available in the manufacturer-independent battery systems AMPShare – Powered by Bosch or CAS – CORDLESS ALLIANCE SYSTEM

**VarioClean-Elektronik**

Optimum adaptation to the type of blockage for faster work progress

**Brushless Motor**

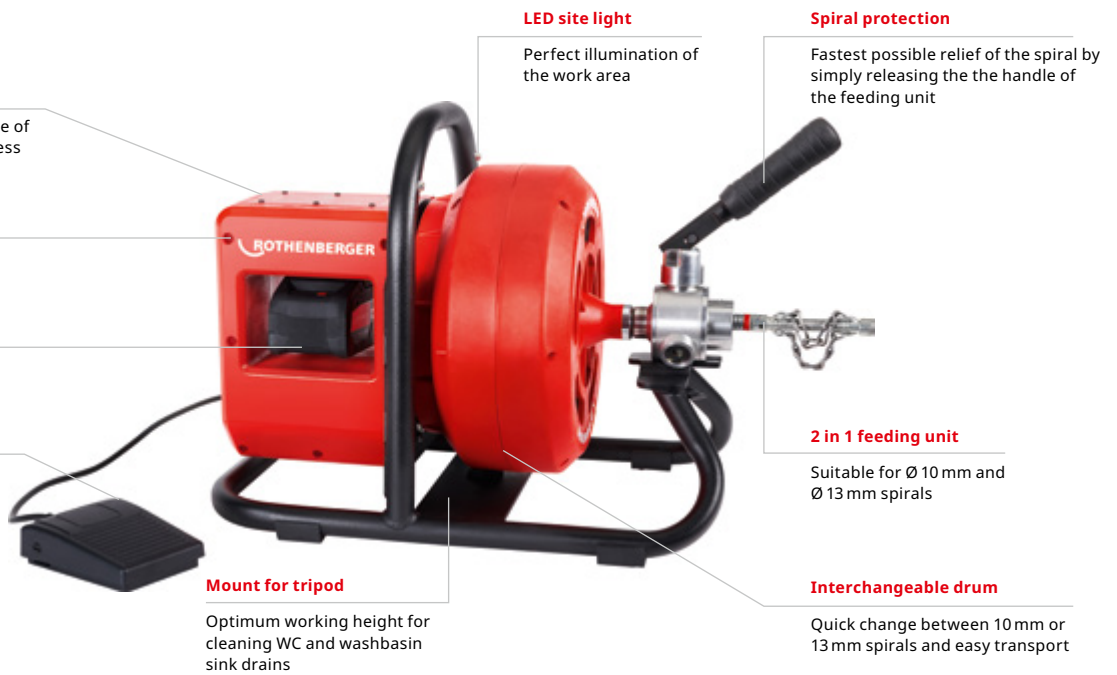
For wear-free work and longer machine life

**Multiple battery systems**

Suitable for AMPShare or CAS battery systems

**Pneumatic foot switch**

For hands free safe working



**LED site light**

Perfect illumination of the work area

**Spiral protection**

Fastest possible relief of the spiral by simply releasing the the handle of the feeding unit

**2 in 1 feeding unit**

Suitable for Ø 10 mm and Ø 13 mm spirals

**Interchangeable drum**

Quick change between 10 mm or 13 mm spirals and easy transport

**Mount for tripod**

Optimum working height for cleaning WC and washbasin sink drains

Model	Weight	PU	AMPShare-No.	CAS-No.
RODRUM VarioClean bare tool, DuraFlex spiral 13 mm, spiral-length 15 m	21.800 kg	1	1000004143	1000003347
RODRUM VarioClean, DuraFlex spirale 13 mm, spiral-length 15 m, 8 Ah battery, charger	26.600 kg	1	1000004145	1000003371
RODRUM VarioClean, DuraFlex SMK spiral 13 mm, spiral-length 15 m , tool set 16 mm, 8 Ah battery, charger	29.000 kg	1	1000004144	1000003348

Accessories	Weight	PU	No.
DuraFlex spiral drum, 13 mm / 15 m	12.500 kg	1	1500003708
DuraFlex spiral 13 mm / 15 m	10.000 kg	1	1500003706
DuraFlex spiral 10 mm / 10 m	4.000 kg	1	1500003707

For spare spirals see page 271



## RODRUM M

**Drum drain cleaning machine with automatic spiral feed. For pipes from Ø 70–125 mm. Perfectly suited for use in public and commercial buildings as well as house connection pipes**

- RODRUM M is a drum drain cleaning machine with automatic spiral feed for removal of blockages in pipes from Ø 70–250 mm.
- Due to the interchangeable drums the machine can be adapted to different pipe diameters quickly without usage of any tools.
- The dirty spiral runs back into the drum and keeps the surrounding free of dirt.
- The clean and discrete way of working is ideal for Plumbers, facility managers, drain cleaners for jobs in private households, as well as public buildings like hotels or restaurants.

### Interchangeable drum

Fast change between Ø 13–16 mm spirals

### 3-in-1 feeding unit

No retrofitting necessary for different spiral diameters



### Application Benefits

- Interchangeable drums for quick and easy adaption to different pipe diameters without use of any tool
- Clean and discreet use
- Easy handling due to automatic spiral feeding and retrieving
- Spiral protection due to direct pressure relief by release of the lever
- Machine works with Ø 13, 16, 20 mm spirals

### Technical Data

Input power	620 W
Spiral diameter	13–16 mm
Working area diameter	70–125 mm
Working area Length	15 m
Speed	270 rpm

Model	Weight	PU	No.
RODRUM M 13 with tool set, EU	45.500 kg	1	1000001711
RODRUM M 16 with tool set, EU	50.200 kg	1	1000001712

## RODRUM L

**Drum drain cleaning machine with automatic spiral feed. For pipes from Ø 75–250 mm. Perfectly suited for use in public and commercial buildings as well as house connection pipes**

- RODRUM L is a drum drain cleaning machine with automatic spiral feed for removal of blockages in pipes from Ø 75–250 mm.
- Due to the interchangeable drums the machine can be adapted to different pipe diameters quickly without usage of any tools.
- The dirty spiral runs back into the drum and keeps the surrounding free of dirt.
- The clean and discrete way of working is ideal for Plumbers, facility managers, drain cleaners for jobs in private households, as well as public buildings like hotels or restaurants.

### Interchangeable drum

Fast change between Ø 16–20 mm spirals

### 3-in-1 feeding unit

No retrofitting necessary for different spiral diameters



### Application Benefits

- Interchangeable drums for quick and easy adaption to different pipe diameters without use of any tool
- Clean and discreet use
- Easy handling due to automatic spiral feeding and retrieving
- Spiral protection due to direct pressure relief by release of the lever
- Machine works with Ø 13, 16, 20 mm spirals

### Technical Data

Input power	620 W
Spiral diameter	16–20 mm
Working area diameter	75–250 mm
Working area Length	30 m
Speed	270 rpm

Model	Weight	PU	No.
RODRUM L 16 with tool set, EU	51.900 kg	1	1000001713
RODRUM L 20 with tool set, EU	68.000 kg	1	1000001714

## Flushing and pipe cleaning

### Pipe cleaning drums with spirals

#### RODRUM M and L drums

Spiral drums for quickly and easily extending the range or for adapting the working range of the RODRUM M and L drain cleaning machines to other pipe diameters

#### Application Benefits

- Quick-change system for simple adjustment of the machine to other pipe diameters
- Tool-less exchangeable for quick and easy machine retooling



No. 1000001730

No. 1000001728

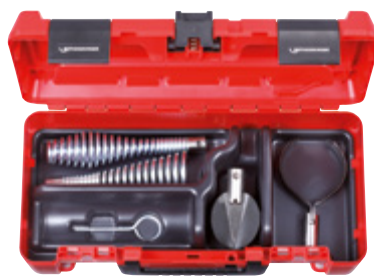
Model	Weight	PU	No.
RODRUM drum M 13 incl. spiral 13 mm × 15 m	14.500 kg	1	1000001727
RODRUM drum M 16 incl. spiral 16 mm × 15 m	19.000 kg	1	1000001728
RODRUM drum L 16 incl. 2 × spiral 16 mm × 15 m	38.700 kg	1	1000001729
RODRUM drum L 20 incl. spiral 20 mm × 20 m	36.800 kg	1	1000001730

Accessories	Weight	No.	Accessories	Weight	No.
Straight auger, 20 mm <sup>1</sup>	0.320 kg	1500002253	Forked cutter 80, 20 mm <sup>1</sup>	0.150 kg	1500002263
Funnel auger, 20 mm <sup>1</sup>	0.550 kg	1500002254	Forked cutter 100, 20 mm <sup>1</sup>	0.200 kg	1500002264
Bulb auger, 20 mm <sup>1</sup>	0.400 kg	1500002255	Two-way root cutter 65, 20 mm <sup>1</sup>	0.390 kg	1500002265
Retrieving auger, 20 mm <sup>1</sup>	0.120 kg	1500002256	Two-way root cutter 90, 20 mm <sup>1</sup>	0.460 kg	1500002266
Peak-head auger, 20 mm <sup>1</sup>	0.400 kg	1500002257	Adaptor, square-coupling to 22 mm T-coupling	0.250 kg	1500002267
Cross-blade cutter 50, 20 mm <sup>1</sup>	0.160 kg	1500002258	Spiral 13 × 15 with inner core	10.800 kg	1500002271
Cross-blade cutter 65, 20 mm <sup>1</sup>	0.230 kg	1500002259	Spiral 16 × 15 with inner core	15.500 kg	72918
Cross-blade cutter 90, 20 mm <sup>1</sup>	0.390 kg	1500002260	Spiral 20 × 20 with inner core	33.500 kg	1500002268
Chain-spinning head 4 chains, 20 mm <sup>1</sup>	0.300 kg	1500002261	RODRUM tool kit 16 mm		1000001731
Forked cutter 60, 20 mm <sup>1</sup>	0.100 kg	1500002262	RODRUM tool kit 20 mm		1000001732

1) All 20 mm augers with square coupling



No. 1000001731

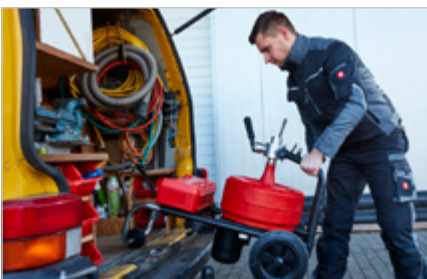


No. 1000001732

**Set (No. 1000001731) includes:**  
 ROCASE (No. 1300003334) with inlay (No. 1300003372), chain-spinning head (No. 072185F), cross-blade cutter (No. 72176), forked cutter (No. 72164), bulb auger (No. 72163), retrieving auger (No. 72162), straight auger (No. 72161), separating key (No. 72100)

**Set (No. 1000001732) includes:**  
 ROCASE (No. 1300003334) with inlay (No. 1300003372), bulb auger (No. 1500002255), cross-blade cutter (No. 1500002259), forked cutter (No. 1500002263), separating key (No. 72101)

Loading device



Easy transport due to stair capable chassis



Cleaning of a down pipe with 16 mm spiral



### R 550 clutch jaws

#### Replacement clamping jaws for pipe cleaning machine R 550

The internal spiral clamping device can be renewed with the clamping jaw set

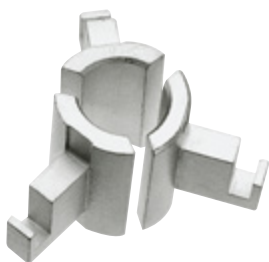


Model	Weight	PU	No.
Clutch jaw for R 550, for spiral 16 mm	0.100 kg	1	72536
Clutch jaw for R 550, for spiral 16 mm	0.100 kg	1	72538

### R 750 clutch jaws

#### Replacement clamping jaws for pipe cleaning machine R 750 for working with 32 mm pipe cleaning spirals

The internal spiral clamping device can be renewed with the clamping jaw set



Model	Weight	PU	No.
Clutch jaws for R 750, 22–32 mm	0.400 kg	1	72563

### Adaptor magazine for R 600 / 650

#### Application Benefits

- Clean, safe storage of 8 and 10 mm spirals
- Impact-resistant container with clutch jaws and precision clutch

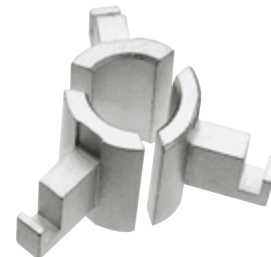


Model	Weight	PU	No.
Adaptor magazine for R 600 / 650, for spiral 10 mm, spiral-length 10 m	1.800 kg	1	72515
Adaptor magazine for R 600 / 650, for spiral 8 mm, spiral-length 10 m	1.800 kg	1	72514

### R 80 / 100 clutch jaws

#### Replacement clamping jaws for pipe cleaning machine R 80 / R 100

The internal spiral clamping device can be renewed with the clamping jaw set



Model	Weight	PU	No.
Clutch jaws for spiral 22 mm	0.400 kg	1	72561
Clutch jaws for spiral 32 mm	0.300 kg	1	72562

### R 600 / 650 clutch jaws

#### Replacement clamping jaws for pipe cleaning machine R 600 / R 650 for working with 16 and 22 mm spirals

The internal spiral clamping device can be renewed with the clamping jaw set

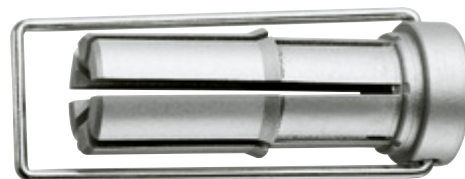


Model	Weight	PU	No.
Clutch jaws for R 600 / 650, 16–22 mm	0.300 kg	1	72638
Clutch jaws for R 600 / 650, 16–22 mm	0.300 kg	1	72666

### Collet for R 750

#### Clutch jaw for the use of 16 mm spirals with the R 750 pipe cleaning machine

For converting the R 750 pipe cleaning machine to use 16 mm spirals



Model	Weight	PU	No.
Collet for R 750, for spiral 16 mm	0.300 kg	1	72915

### Spiral guide hose for R 750 / 80 / 100 SP / R 140 B

#### Application Benefits

- Prevents contamination and damage



Model	Weight	PU	No.
Spiral guide hose for R 750, for spiral 32 mm, spiral-length 4 m	4.100 kg	1	72559

### Spiral guide hose for R 600 / 650

#### Application Benefits

- Prevents contamination and damage



Model	Weight	PU	No.
Spiral guide hose for R 600/650, for spiral 22 mm, spiral-length 4 m	2.800 kg	1	72541

### Spiral guide hose for R 550

#### Application Benefits

- Prevents contamination and damage



Model	Weight	PU	No.
Spiral guide hose for R 550/RODRUM S, for spiral 16 mm, spiral-length 2 m	1.100 kg	1	72540

### Tripod stand

Tripod base for pipe cleaning machines R 550, R 600, R 650, and R 750. Additionally also for the spiral return device

#### Application Benefits

- Collapsible and galvanised
- Provides an ideal working height of the drain cleaning machine, for example: inspection holes in downpipes
- Spiral retrieving device



Model	Weight	PU	No.
Tripartine	3.000 kg	1	58182

11

### Spiral retrieving device

#### Application Benefits

- Safe forward / backward transport of spirals in drop lines
- Suitable for all open wound spirals with Ø 22 mm and 32 mm
- Can also be used as a feed unit for difficult blockages
- Can be used without any problems as an attachment for third-party products
- With water connection (2 connection fittings 1")
- Mount for tripod base



Model	Weight	PU	No.
Spiral retrieving device	3.700 kg	1	72135

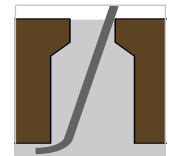
### Telescoping guide tubes

Telescoping guide tube for kink-free insertion of pipe cleaning spirals up to 22 mm diameter in manholes

For use with pipe and sewer cleaning machines on manholes to safely guide spirals up to 22 mm into the pipeline

#### Application Benefits

- No twisting: For safe spiral guidance in manholes and manhole covers



Model	Weight	PU	No.
Telescoping guide tube for spirals Ø 16–22 mm, extended length 1,4–2,3 m, 3.000 kg 2 pieces		1	72130

### ROWONAL care and rust remover

#### Application Benefits

- For cleaning, preservation and protection of spirals, couplings and tools
- For cleaning, rust-removal



Model	Weight	PU	No.
ROWONAL Spray can, 0.2l	0.220 kg	1	72142
ROWONAL Plastic canister, 5l	5.100 kg	1	72140

### Separating pin

#### Application Benefits

- Fast and uncomplicated uncoupling of pipe cleaning spirals and tools



Model	Weight	PU	No.
Separating pin for spirals and tools with Ø 8 mm	0.010 kg	1	72102
Separating pin for spirals and tools with Ø 16 mm	0.010 kg	1	72100
Separating pin for spirals and tools with Ø 22 and 32 mm	0.030 kg	1	72101

### Spiral guide gloves

#### Application Benefits

- Safe handling and guiding of pipe cleaning spirals



Model	Weight	PU	No.
Guide glove pair, rubber	0.160 kg	1	1500000439
Guide gloves right, leather	0.190 kg	1	72121
Guide gloves left, leather	0.190 kg	1	72120

### Spiral baskets

#### Application Benefits

- Safe storage combined with convenient transport
- Perfectly suited for cleaning and preservation



Model	Weight	PU	No.
For spirals with Ø 16 mm	1.300 kg	1	72110
For spirals with Ø 22–32 mm	2.300 kg	1	72111
For spirals with Ø 22 mm	1.600 kg	1	72112

## ROTHENBERGER high-performance drain cleaning spirals

For the toughest demands during continuous operation

### Application Benefits

- **Bevelled lead-ins on the T-groove coupling**
- Quick, trouble-free coupling even when wearing gloves
- **For the toughest demands even during continuous operation.** Different wire gauge can be chosen depending on use, high material characteristics, perfected production process
- **Maximum spring tension with high elasticity and flexibility.** Specially hardening process

- **Optimum high torque transmission.** Tightly wound spiral with short pitch
- **Increased spiral tension when machine turns clockwise and depending on the resistance of the obstruction.** Professional left-handed wound spiral

### Technical data

- Manufactured from quality spring steel, type C DIN EN 10270-1 Material No. 11200
- Specially hardened and tempered
- Safety T-groove coupling system with NIROSTA- pressure pin locking mechanism
- Spring mounted NIROSTA pressure pin with NIROSTA spring

## ROTHENBERGER lockring

With locking



### Coupling with 100% surface pressure

Self locking connection of spiral and coupling: With increased stress on the spiral, the torque pressure on the spiral end is increased and is transferred with 100% surface coverage onto the coupling.

### Sufficient connecting coil

Spare couplings can be mounted easily



### Various wire gauges

Flexible, depending on use



### Insertion taper

Simple coupling of spirals and tools

### ROPOWER profile cable

Additional cleaning effect with the squared profile



### Plastic core

Spiral won't clog with dirt



### T-groove made of Nirosta steel

Long lasting and high functional safety with the high-quality coupling design

Spiral/type	Short distance many bends	Long distance straight run	No clogging of the spiral with dirt	Additional cleaning power
Standard spiral	●	○	○	○
SMK-spiral	●	○	●	○
DuraFlex spiral	●●	○	●	○
S-spiral	○	●	○	○
S-SMK-spiral	○	●	●	○
ROPOWER profile	○	●	●	●

● suitable ○ unsuitable

## ROPOWER profile cable

Spiral with special galvanized wire shape



### Application Benefits

- Squared spiral wire profile (DIN EN 10270-1) Additional cleaning effect on pipe wall
- Plastic core: No clogging of the spiral with dirt
- Especially suitable for working over long distances



Profile edge

50% more cleaning power when used with the spiral tools

Model	Weight	PU	No.
Spiral ROPower, 16 mm (5/8"), length 2.3 m	1.300 kg	1	72490

## SMK-spirals

### Application Benefits



- Flexible spiral, for cleaning jobs with short distances with a succession of pipe bends
- Additional protection of the spiral from clogging with the plastic core



Model	Weight	PU	No.
Spiral SMK, 16 mm (5/8"), length 2.3 m, wire 3 mm, R/K C 8	1.240 kg	1	72433
Spiral SMK, 22 mm (7/8"), length 4.5 m, wire 4.5 mm, R/K C 10	4.640 kg	1	72442
Spiral SMK, 32 mm (1.1/4"), length 4.5 m, wire 5 mm, R/K C 11	7.630 kg	1	72452

## S-SMK-spirals

### Application Benefits



- Very stable spiral with increased wire diameter for long distances and less bends
- High rigidity, suitable for demanding work, such as root cutting, milling
- Additional protection of the spiral from clogging with the plastic core



Model	Weight	PU	No.
Spiral S-SMK, 16 mm (5/8"), length 2.3 m, wire 3.5 mm, R/K E 8	1.300 kg	1	72435
Spiral S-SMK, 22 mm (7/8"), length 4.5 m, wire 5 mm, R/K E 10	4.780 kg	1	72444
Spiral S-SMK, 32 mm (1.1/4"), length 4.5 m, wire 6 mm, R/K E 11	7.850 kg	1	72455

## Standard spirals

### Application Benefits



- Flexible spiral, for cleaning jobs with short distances with a succession of pipe bends



Model	Weight	PU	No.
Spiral standard, 16 mm (5/8"), length 2.3 m, wire 3 mm, R/K C 8	1.050 kg	1	72431
Spiral standard, 22 mm (7/8"), length 4.5 m, wire 4,5 mm, R/K C 10	3.980 kg	1	72441
Spiral standard, 32 mm (1.1/4"), length 4.5 m, wire 5 mm, R/K C 11	6.290 kg	1	72451

## S-spirals

### Application Benefits



- Very stable spiral with increased wire diameter for long distances and less bends
- High rigidity, suitable for demanding work, such as root cutting, milling



Model	Weight	PU	No.
Spiral S, 16 mm (5/8"), length 2.3 m, wire 3,5 mm, R/K E 8	3.000 kg	1	72428
Spiral S, 22 mm (7/8"), length 4.5 m, wire 5 mm, R/K E 10	4.180 kg	1	72443
Spiral S, 32 mm (1.1/4"), length 4.5 m, wire 6 mm, R/K E 10	6.500 kg	1	72453

## DuraFlex spirals

### Application Benefits



- Very light and flexible spirals, optimal for use with the battery-operated R600 VarioClean
- Zinc plating for extended service life



Model	Weight	PU	No.
DuraFlex spiral, SMK, 16 mm (5/8"), length 2.3 m	0.800 kg	1	1500003703
DuraFlex spiral, SMK, 22 mm (7/8"), length 4.5 m	3.800 kg	1	1500003704

**Examples of use**

**Tool expertise from ROTHENBERGER**

Application areas for ROTHENBERGER high-performance drain cleaning tools with T-groove secure couplings

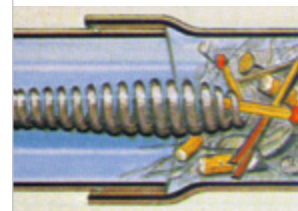
**Suitable for all ROTHENBERGER drain cleaning spirals with  $\varnothing$  16 mm-5/8";  $\varnothing$  22 mm-7/8";  $\varnothing$  32 mm-1.1/4"**

See the following pages for more information on professional tools in various versions and dimensions for loosening obstructions and cleaning drains.

**Bulb auger**



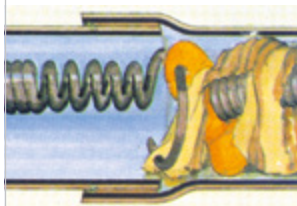
The most common tool for cleaning pipes and drains with tight or multiple bends



**Retrieving auger**



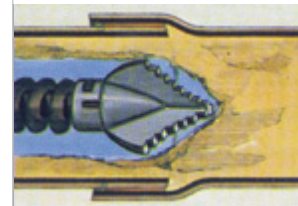
Special tool for retrieving objects from the pipe, e.g. textiles, spirals or tools



**Cross-blade cutter, serrated**



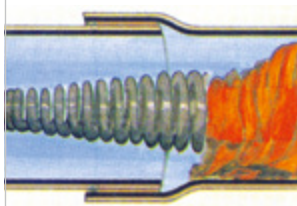
Special tool for opening up solidified pipe obstructions



**Funnel auger**



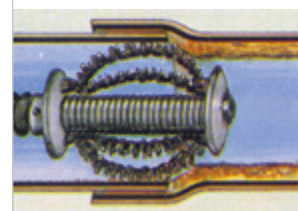
Tool for removing, opening or retrieving obstructions caused by, e.g. textiles



**Chain-spinning head**



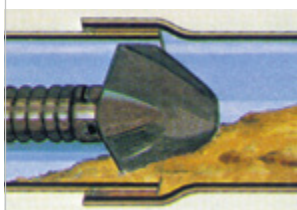
For concrete, cast iron and ceramic pipes. Intensive action.



**Spade head cutter**



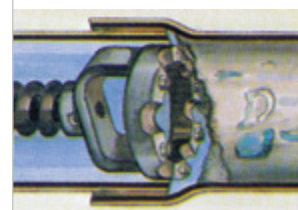
Ideally suited for slit or sludge deposits in pipes, and as a follow-up tool



**Carbide-tipped cutters**



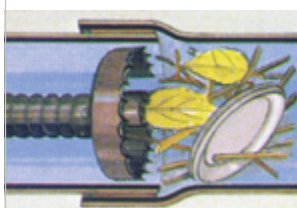
This carbide-tipped tool is used to remove the hardest obstructions such as cement, urine and water scale etc.



**Spiral sawtooth cutter**



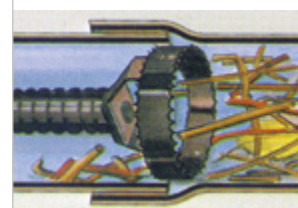
Special tool for chopping up small roots and other material that have become caught in the pipe



**Two-way root cutter**



Special tool for cutting roots in both directions. Also suitable for solid materials





## Bulb auger long

### Application Benefits

- With the longer, more flexible range the bulb auger is considerably more flexible in curves. Pipe from Ø 40 mm



Model	Weight	PU	No.
Bulb auger long, coupling 16 mm (5/8"), working range 40–75 mm	0.220 kg	1	72158
Bulb auger long, coupling 22 mm (7/8"), working range 50–100 mm	0.464 kg	1	72208

## Straight auger

### Application Benefits

- Standard tool for investigating the nature of an obstruction
- For piercing or drilling through obstructions caused by textiles, paper, cellulose materials, kitchen refuse etc.
- For removing samples to determine a suitable clearing tool



Model	Weight	PU	No.
Straight auger coupling 16 mm (5/8"), working range 40–75 mm	0.060 kg	1	72161
Straight auger coupling 22 mm (7/8"), working range 75–100 mm	0.170 kg	1	72221
Straight auger coupling 32 mm (1.1/4"), working range 100–250 mm	0.350 kg	1	72321

## Funnel auger

### Application Benefits

- For removing or opening up obstructions caused by textiles or paper
- Large grasping ability can also be used to retrieve spirals from drains



Model	Weight	PU	No.
Funnel auger coupling 16 mm (5/8"), working range 50–100 mm	0.080 kg	1	72165
Funnel auger coupling 22 mm (7/8"), working range 110–150 mm	0.280 kg	1	72222
Funnel auger coupling 32 mm (1.1/4"), working range 100–250 mm	0.500 kg	1	72322

## Bulb auger short

### Application Benefits

- Suitable for tight pipe bends
- Standard, highly flexible tool for clearing light textile and paper obstructions



Model	Weight	PU	No.
Bulb Auger short, coupling 16 mm (5/8"), working range 40–75 mm	0.070 kg	1	72163
Bulb Auger short, coupling 22 mm (7/8"), working range 75–100 mm	0.220 kg	1	72263
Bulb Auger short, coupling 32 mm (1.1/4"), working range 75–250 mm	0.490 kg	1	72363

## Retrieving auger

### Application Benefits

- Special tool designed with a claw for retrieving textiles, tools, spirals etc



Model	Weight	PU	No.
Retrieving auger coupling 16 mm (5/8"), working range 50–75 mm	0.035 kg	1	72162
Retrieving auger coupling 22 mm (7/8"), working range 75–150 mm	0.110 kg	1	72203
Retrieving auger coupling 32 mm (1.1/4"), working range 75–250 mm	0.240 kg	1	72325

## Drop-head auger

### Application Benefits

- Ideal for particularly tight pipe bends, branches and small-diameter drain downpipes



Model	Weight	PU	No.
Drop-head auger coupling 16 mm (5/8"), working range 50–75 mm	0.060 kg	1	72159
Drop-head auger coupling 22 mm (7/8"), working range 60–100 mm	0.180 kg	1	72264

### Four-blade cutter

#### Application Benefits

- For cutting through and removing tough obstructions
- For the removal of sludge deposits
- Ideal with S-spirals



**Hardened spring steel blades!**



Model	Weight	PU	No.
Coupling 16 mm (5/8"), working range 50–75 mm	0.030 kg	1	72154
Coupling 16 mm (5/8"), working range 50–75 mm	0.020 kg	1	72164

### Spade head cutter

#### Application Benefits

- Curved special tool for silt and sludge deposits



Model	Weight	PU	No.
Coupling 22 mm (7/8"), working range 100–150 mm	0.150 kg	1	72261
Coupling 32 mm (1.1/4"), working range 100–150 mm	0.250 kg	1	72360

### Grease cutter

#### Application Benefits

- Standard tool for removing grease and other soft deposits, e. g. soap accumulations



Model	Weight	PU	No.
Coupling 16 mm (5/8"), working range 40–75 mm	0.030 kg	1	72169
Coupling 16 mm (5/8"), working range 50–75 mm	0.040 kg	1	72170
Coupling 16 mm (5/8"), working range 60–100 mm	0.050 kg	1	72171
Coupling 22 mm (7/8"), working range 60–125 mm	0.080 kg	1	72234

### Spiral sawtooth cutter

#### Application Benefits

- Special tool for chopping up small roots, branches and other materials
- Not suitable for plastic pipes!



Model	Weight	PU	No.
Coupling 16 mm (5/8"), working range 50–75 mm	0.040 kg	1	72166
Coupling 22 mm (7/8"), working range 75–100 mm	0.100 kg	1	72229
Coupling 32 mm (1.1/4"), working range 75–100 mm	0.210 kg	1	72329

11

### Cross-blade cutter, serrated

#### Application Benefits

- Powerful combination tool for grinding up and removing solidified obstructions
- For coarse removal of incrustations
- As preparatory tool for chain spinning

Model	Weight	PU	No.
Coupling 16 mm (5/8"), working range 50–75 mm	0.040 kg	1	72176
Coupling 16 mm (5/8"), working range 50–75 mm	0.030 kg	1	72175
Coupling 16 mm (5/8"), working range 75–100 mm	0.065 kg	1	72177
Coupling 16 mm (5/8"), working range 100–125 mm	0.080 kg	1	72178

• Used for textile or sludge obstructions!  
 • Hardened, break-proof, spring steel blades!  
 • Recommended for use with S or SMK-spirals!



Model	Weight	PU	No.
Coupling 22 mm (7/8"), working range 100–125 mm	0.090 kg	1	72275
Coupling 22 mm (7/8"), working range 100–150 mm	0.190 kg	1	72276
Coupling 22 mm (7/8"), working range 100–150 mm	0.220 kg	1	72277

## Chain-spinning heads

### Without ring, with smooth chain

#### Application Benefits

- For cleaning greasy and incrustated pipes
- Surface-preserving cleaning of ceramic and plastic pipes
- Without ring: improved manoeuvrability in bends



No. 72284



Improved mobility!

Model	Weight	PU	No.
<b>Without ring, with 2 chains</b>			
Coupling 16 mm (5/8"), working range 50–125 mm	0.120 kg	1	072185F
Coupling 16 mm (5/8"), working range 100–125 mm	0.160 kg	1	72185
Coupling 22 mm (7/8"), working range 100–150 mm	0.530 kg	1	72284
<b>Without ring, with 4 chains</b>			
Coupling 16 mm (5/8"), working range 60–125 mm	0.270 kg	1	72187
Coupling 22 mm (7/8"), working range 80–130 mm	0.710 kg	1	72289

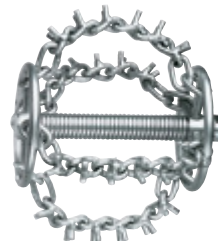


No. 72289

## Chain-spinning heads with spikes

#### Application Benefits

- Intensive cleaning action
- Ideal for concrete and cast iron pipes
- Reduces the risk of renewed obstructions
- Perfectly suitable for down pipes
- **With ring:**  
for better centering in horizontal pipe runs
- **Without ring:**  
Improved mobility in bends



No. 72286



Ideal for final cleaning!

## Chain-spinning heads with ring and spikes

Model	Weight	PU	No.
Chain-spinning head with ring, with spikes, with 4 chains, coupling 22 mm (7/8"), working range 100–125 mm	1.060 kg	1	72285
Chain-spinning head with ring, with spikes, with 4 chains, coupling 22 mm (7/8"), working range 100–150 mm	1.110 kg	1	72286
Chain-spinning head with ring, with spikes, with 4 chains, coupling 32 mm (1.1/4"), working range 100–125 mm	1.700 kg	1	72341

Better alignment in horizontal pipe position!

## Without ring, with 2 or 4 chains and spikes

Model	Weight	PU	No.
<b>Without ring, with 2 chains</b>			
Chain-spinning head without ring, with spikes, with 2 chains, coupling 16 mm (5/8"), working range 50–125 mm	0.160 kg	1	72186
Chain-spinning head without ring, with spikes, with 2 chains, coupling 22 mm (7/8"), working range 100–150 mm	0.860 kg	1	72278
<b>Without ring, with 4 chains</b>			
Chain-spinning head without ring, with spikes, with 4 chains, coupling 16 mm (5/8"), working range 75–125 mm	0.280 kg	1	72188
Chain-spinning head without ring, with spikes, with 4 chains, coupling 22 mm (7/8"), working range 100–150 mm	0.880 kg	1	72299
Chain-spinning head without ring, with spikes, with 4 chains, coupling 32 mm (1.1/4"), working range 100–200 mm	1.460 kg	1	72348



No. 72278

Improved mobility!



No. 72188

### Carbide-tipped cutter

#### Application Benefits

- Carbide-tipped cutters for the hardest obstructions and incrustations such as cement deposits, urine and water scale and other hard deposits
- Recommended for use with S- or SMK-spirals

#### Carbide-tipped cutters!



Model	Weight	PU	No.
Coupling 16 mm (5/8"), working range 40–75 mm	0.070 kg	1	72191
Coupling 16 mm (5/8"), working range 50–75 mm	0.080 kg	1	72193
Coupling 22 mm (7/8"), working range 60–100 mm	0.320 kg	1	72295

### Two-way root cutter

#### Application Benefits

- With hardened spring steel cutter for chopping up roots in both directions
- Recommended for use with S- or SMK-spirals
- Not suitable for use with plastic pipes

#### Replaceable blades!



Model	Weight	PU	No.
Coupling 22 mm (7/8"), working range 100–125 mm	0.250 kg	1	72265
Coupling 22 mm (7/8"), working range 125–200 mm	0.290 kg	1	72266
Coupling 32 mm (1.1/4"), working range 100–125 mm	0.290 kg	1	72365
Coupling 32 mm (1.1/4"), working range 125–200 mm	0.330 kg	1	72366

### Serrated forked cutter

#### Application Benefits

- Particularly suitable for sludge deposits and roots
- Hardened spring steel cutter with teeth on both sides, long service life



Model	Weight	PU	No.
Coupling 22 mm (7/8"), working range 100–150 mm	0.230 kg	1	72250
Coupling 22 mm (7/8"), working range 125–150 mm	0.240 kg	1	72251
Coupling 32 mm (1.1/4"), working range 120–200 mm	0.260 kg	1	72350
Coupling 32 mm (1.1/4"), working range 125–200 mm	0.240 kg	1	72351

### Ball head cutter

#### Application Benefits

- Perfectly suited for use in pipes with hard incrustations such as lime, urine scale etc.
- Suitable for downpipes, its round shape ensures excellent curve mobility even at 90°



Model	Weight	PU	No.
<b>4 Blades</b>			
Coupl. 16 mm (5/8"), range 50–75 mm	0.042 kg	1	72168
Coupl. 16 mm (5/8"), range 50–75 mm	0.080 kg	1	72172
Coupl. 22 mm (7/8"), range 100–125 mm	0.198 kg	1	72223
Coupl. 22 mm (7/8"), range 100–150 mm	0.438 kg	1	72224
Coupl. 22 mm (7/8"), range 100–150 mm	0.634 kg	1	72226
Coupl. 32 mm (1.1/4"), range 100–125 mm	0.228 kg	1	72324
Coupl. 32 mm (1.1/4"), range 100–150 mm	0.468 kg	1	72326
<b>8 Blades</b>			
Coupl. 22 mm (7/8"), range 125–150 mm	1.025 kg	1	72227
Coupl. 22 mm (7/8"), range 125–150 mm	1.225 kg	1	72228
Coupl. 32 mm (1.1/4"), range 125–200 mm	1.108 kg	1	72327
Coupl. 32 mm (1.1/4"), range 150–200 mm	1.256 kg	1	72328

**Tool set L, 16 mm, for R 550 / 600 / 650**

Ø 16 mm, 10 pieces

**RO  
CASE**


Set (No. 72936) includes: ROCASE (No. 1300003334) with inlay (No. 1300003372), separating key 16 mm (No. 72100), retrieving auger 16 mm (No. 72162), bulb auger 16 mm (No. 72163), serrated forked cutter 16 mm (No. 72164), blade cutter 16 / 25 mm (No. 72169), cross-blade cutter 16 / 45 mm (No. 72177), chain-spinning head 16 mm with 2 smooth chains (No. 72185), guide gloves, left / right (No. 1500000439), ROWONAL spiral spray (No. 72142)

Model	Weight	PU	No.
Tool set L, 16 mm, for R 550 / 600 / 650	1.775 kg	1	72936

**Tool set S, 16 mm, for R 550 / 600 / 650**

Ø 16 mm, 5-pieces



Set (No. 72937) includes: separating pin 16 mm (No. 72100), straight auger 16 mm (No. 72161), bulb auger 16 mm (No. 72163), blade cutter 16 mm (No. 72169), cross-blade cutter 16 mm (No. 72175)

Model	Weight	PU	No.
Tool set S, 16 mm, for R 550 / 600 / 650	0.210 kg	1	72937

**Tool set L, 22 mm, for R 600 / 650 / 750**

Ø 22 mm, 11 pieces

**RO  
CASE**


Set (No. 72938) includes: ROCASE (No. 1300003334) with inlay (No. 1300003372), separating key 22 mm (No. 72101), retrieving auger 16 mm (No. 72203), serrated forked cutter 22 mm (No. 72250), spade head cutter 22 / 65 mm (No. 72261), bulb auger 22 mm (No. 72263), two-way root cutter 22 / 65 mm (No. 72265), cross-blade cutter 22 / 65 mm (No. 72276), chain-spinning head 22 mm with 2 smooth chains (No. 72284), guide gloves, left / right (No. 1500000439), ROWONAL spiral spray (No. 72142)

Model	Weight	PU	No.
Tool set L, 22 mm, for R 600 / 650 / 750	3.065 kg	1	72938

**Tool set S, 22 mm, for R 600 / 650 / 750**

Ø 22 mm, 6 pieces



Set (No. 72939) includes: separating pin 22 mm (No. 72101), straight auger 22 mm (No. 72221), serrated forked cutter 22 mm (No. 72250), spade head cutter 22 mm (No. 72261), bulb auger 22 mm (No. 72263), cross-blade cutter 22 mm (No. 72276)

Model	Weight	PU	No.
Tool set S, 22 mm, for R 600 / 650 / 750	1.050 kg	1	72939

**Spiral-tool set standard, 16 mm**

Standard Ø 16 mm



Set (No. 072945X) includes: spiral basket 16 mm (No. 72110), 5 × 16 mm standard spirals (No. 72431), straight auger 16 mm (No. 72161), bulb auger 16 mm (No. 72163), blade cutter 16 / 25 mm (No. 72169), separating pin 16 mm (No. 72100), guide gloves, left / right (No. 1500000439), ROWONAL spiral spray (No. 72142), ROCASE (No. 1300003334) with inlay (No. 1300003372)

Model	Weight	PU	No.
Spiral-tool set standard, 16 mm	12.000 kg	1	072945X

**Spiral-tool set standard, 16–22 mm**

Standard Ø 16–22 mm



Set (No. 072956X) includes: spiral basket 16 mm (No. 72110), 5 × 16 mm standard spirals (No. 72431), straight auger 16 mm (No. 72161), bulb auger 16 mm (No. 72163), blade cutter 16 / 25 mm (No. 72169), separating pin 16 mm (No. 72100), spiral basket 22 mm (No. 72112), 5 × 22 mm standard spiral (No. 72441), straight auger 22 mm (No. 72221), bulb auger 22 mm (No. 72263), funnel auger 22 mm (No. 72222), spade head cutter 22 / 65 mm (No. 72261), serrated forked cutter 22 / 76 mm (No. 72250), separating pin 22 / 32 mm (No. 72101), guide gloves, left / right (No. 1500000439), ROWONAL spiral spray (No. 72142), ROCASE (No. 1300003334) with inlay (No. 1300003372)

Model	Weight	PU	No.
Spiral-tool set standard, 16–22 mm	38.000 kg	1	072956X

**Spiral-tool set standard, 22 mm**

Standard Ø 22 mm



Set (No. 072955X) includes: spiral basket 22 mm (No. 72112), 5 × 22 mm standard spirals (No. 72441), straight auger 22 mm (No. 72221), bulb auger 22 mm (No. 72263), funnel auger 22 mm (No. 72222), spade head cutter 22 / 65 mm (No. 72261), serrated forked cutter 22 / 76 mm (No. 72250), separating pin 22 / 32 mm (No. 72101), guide gloves, left / right (No. 1500000439), ROWONAL spiral spray (No. 72142), ROCASE (No. 1300003334) with inlay (No. 1300003372)

Model	Weight	PU	No.
Spiral-tool set standard, 22 mm	24.000 kg	1	072955X

**Spiral-tool set standard, 32 mm**

Standard Ø 32 mm



Set (No. 072962X) includes: spiral basket 32 mm (No. 72111), 5 × 32 mm standard spirals (No. 72451), straight auger 32 mm (No. 72321), retrieving auger 32 mm (No. 72325), funnel auger 32 mm (No. 72322), spade head cutter 32 / 65 mm (No. 72360), spiral sawtooth cutter 32 / 65 mm (No. 72329), separating pin 22 / 32 mm (No. 72101), guide gloves, left / right (No. 1500000439), ROWONAL spiral spray (No. 72142), ROCASE (No. 1300003334) with inlay (No. 1300003372)

Model	Weight	PU	No.
Spiral-tool set standard, 32 mm	37.000 kg	1	072962X

### DuraFlex spiral and tool set

Standard Ø 16 / 22 mm

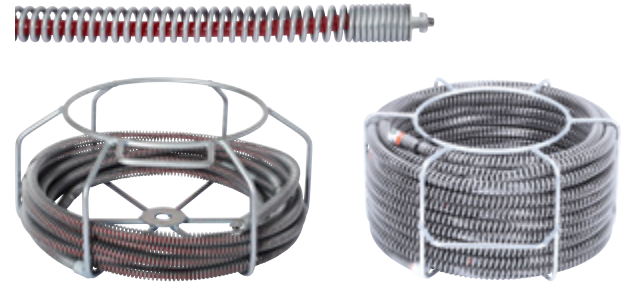


Set (No. 1500003705) includes: spiral basket 16 mm (No. 72110), 5 × 16 mm DuraFlex spirals (No. 1500003703), straight auger 16 mm (No. 72161), bulb auger 16 mm (No. 72163), blade cutter 16 / 25 mm (No. 72169), separating pin 16 mm (No. 72100), spiral basket 22 mm (No. 72112), 5 × 22 mm DuraFlex spirals (No. 1500003704), ROCASE (No. 1300003334) with inlay (No. 1300003372), straight auger 22 mm (No. 72221), bulb auger 22 mm (No. 72263), funnel auger 22 mm (No. 72222), spade head cutter 22 / 65 mm (No. 72261), serrated forked cutter 22 / 76 mm (No. 72250), separating pin 22 / 32 mm (No. 72101), guide gloves, left / right (No. 1500000439), ROWONAL spiral spray (No. 72142)

Model	Weight	PU	No.
DuraFlex SMK spiral and tool set, 16 / 22 mm	34.000 kg	1	1500003705

### DuraFlex spirals

High-quality pipe cleaning spiral made of special DuraFlex steel for removing blockages in pipes.



Model	Weight	PU	No.
DuraFlex spiral drum 13 mm	12.500 kg	1	1500003708
DuraFlex spiral 13 mm	10.000 kg	1	1500003706
DuraFlex spiral 10 mm	4.000 kg	1	1500003707
Spiral DuraFlex, SMK, 16 mm (5/8"), length 2.3 m	0.800 kg	1	1500003703
Spiral DuraFlex, SMK, 22 mm (7/8"), length 4.5 m	3.800 kg	1	1500003704

### Spirals 6 / 8 / 10 mm

For ROSPI H+E PLUS, ROSPI R 36 PLUS, ROSPIMATIC and adaptor magazine

#### Application Benefits

- Heavy duty spiral made out of special steel (DIN EN 10270-1) with integrated bulb auger (except No. 72421, 72423)
- Suitable for ROSPI H+E Plus, ROSPI 36 Plus, ROSPIMATIC as well as with adaptor R 600, R 550
- The wire diameter with an 8 mm spiral averages Ø 2 mm, and with 10 mm spirals Ø 2.5 mm
- Easy to use, even in tight bends, especially with 8 mm spirals also directly through sink strainers, crosses and drains without having to disassemble the drain or stench tap



No. 72412



No. 72421 / No. 72423 with T-groove coupling

Model	Weight	PU	No.
Spiral 6.4 mm, wire 2 mm, length 4.5 m, without core, with bulb auger, for ROSPI 6	0.800 kg	1	72522
Spiral 8 mm, wire 2 mm, length 7.5 m, type C1, without core, with bulb auger, for ROSPI 8-36	1.800 kg	1	72412
Spiral 8 mm, wire 2 mm, length 7.5 m, type C1-IC, with core, with bulb auger, for ROSPI 8-36	2.300 kg	1	72413
Spiral 8 mm, wire 2 mm, length 10 m, without core, with bulb auger, for ROSPI 8-36	2.400 kg	1	72414
Spiral 8 mm, wire 2 mm, length 10 m, with core, with bulb auger, for ROSPI 10-36	3.000 kg	1	72415
Spiral 10 mm, wire 2.5 mm, length 10 m, type C5, without core, with bulb auger, for ROSPI 10-36	3.500 kg	1	72422
Spiral 10 mm, wire 2.5 mm, length 7.5 m, type C4, without core, with bulb auger, for ROSPI 10-36	2.900 kg	1	72420
Spiral 10 mm, wire 2.5 mm, length 7.5 m, type C4-IC, with core, with bulb auger, for ROSPI 10-36	3.300 kg	1	72424
Spiral 10 mm, wire 2.5 mm, length 7.5 m, without core, without bulb auger, for ROSPI 10-36	2.850 kg	1	72421
Spiral 10 mm, wire 2.5 mm, length 7.5 m, with core, without bulb auger, for ROSPI 10-36	2.900 kg	1	72423

### Reducing / extension pieces

#### For spirals with T-coupling

Within limits, tools with larger or smaller lead-ins can also be adapted

#### Application Benefits

- Allows the combination of different spiral diameters



Model	Weight	PU	No.
Reducing negative 22 mm, positive 16 mm	0.150 kg	1	72460

Model	Weight	PU	No.
Extension negative 16 mm, positive 22 mm	0.140 kg	1	72461
Extension negative 22 mm, positive 32 mm	0.320 kg	1	72463

### Safety T-couplings

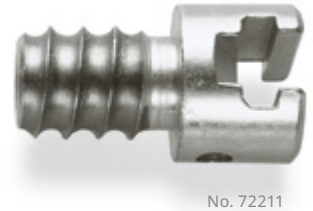
#### for Standard- and SMK-spirals

For the preparation of damaged spirals

**Fixing of broken spirals!**

#### Application Benefits

- Replacing broken spiral couplings



Model	Weight	PU	No.
Safety T-couplings positive	0.020 kg	1	72150
Safety T-couplings negative	0.020 kg	1	72151
Safety T-coupling positive, coupling 22 mm (7/8")	0.040 kg	1	72210
Safety T-coupling negative, coupling 22 mm (7/8")	0.040 kg	1	72211



## High-pressure drain cleaning

HD 13 / 100

HD 17 / 190



Operation mode	230 V	400 V
Max. pipe diameter	150 mm	200 mm
Max. working length	20 m	40 m
Max. pressure	100 bar	190 bar
Pump delivery	13 l/min	17 l/min
Power	2,300 W	5,000 W

### HD 13 / 100

100 bar high-pressure pipe cleaning unit with hose reel



#### Application Benefits

- Air-filled transport wheels, easy to navigate stairs
- AC supplied, self-priming up to 2 m

#### Technical Data

Max. operating pressure	100 bar
Electric motor	AC supply
Pump delivery	13 l/min
Rating	2.3 kW
Max. working length	20 m
Speed	1,400 rpm

Ø 150 mm



Scope of delivery: HD 13 / 100 (No. 76020), hose reel with 20 m special high-pressure hose (No. 72812) with couplings and pipe cleaning nozzle (No. 76089)

Model	Weight	PU	No.
HD 13 / 100	45.000 kg	1	76020

### HD 17 / 190

190 bar high-pressure cleaner with three-phase motor



#### Application Benefits

- Three-phase motor, self-priming up to 2 m
- Air-filled transport wheels, easy to navigate stairs

#### Technical Data

Max. operating pressure	190 bar
Electric motor	Three phase
Pump delivery	17 l/min
Rating	5.0 kW
Max. working length	40 m
Speed	2,800 rpm

Ø 200 mm



Scope of delivery: HD 17 / 190 (No. 76070), hose reel with 40 m special high-pressure hose DN 8 with couplings (No. 72820) and pipe cleaning nozzle (No. 76089)

Model	Weight	PU	No.
HD 17 / 190	50.000 kg	1	76070

### High-pressure hose

#### High pressure hose for cleaning sewage pipes

##### Application Benefits

- Highly flexible for good sheet travel



Model	Weight	PU	No.
High-pressure hose, flexible, coupling R 1/4", length 40 m, NW 8, for HD 17/ 190, HD 19/180 B	10.700 kg	1	72820

### Wash lance

#### Washing lance for use with high-pressure cleaners for cleaning surfaces

##### Application Benefits

- Washing lance for thorough cleaning of surfaces with high pressure cleaners



Model	Weight	PU	No.
Cleaning lance with wide-angle nozzle	1.300 kg	1	76068

## Pipe cleaning nozzles

Pipe cleaning nozzle for removing blockages in sewage pipes up to 150 mm in diameter with the HD 13 / 100, 17 / 190, 19 / 180 B high pressure cleaner

For cleaning pipes, drains, house connections, rainwater downpipes or other cleaning work in the sewer area

### Application Benefits

- Thorough pipe cleaning even in small pipe diameters



No. 76065



No. 76089

## Injector suction hose

for cleaning agent



No. 76067

Model	Weight	PU	No.
Rotary nozzle 45°, 4 holes	0.080 kg	1	77506
Pipe cleaning nozzle with forward jet spray, 5 holes, R 1/4"	0.040 kg	1	76065
Pipe cleaning nozzles without forward jet spray, 5 holes, R 1/4"	0.040 kg	1	76089
Spare wide-angle nozzle	0.010 kg	1	76088
Injector suction hose for cleaning agent, 1.2 m	0.750 kg	1	76067









## Plastic pipe welding






<b>System overview</b>	278-279
<b>Butt welding hydraulic</b>	
ROWELD type Premium CNC	282
ROWELD type Professional	283
ROWELD type Standard	284
Machines for workshop	286
<b>Butt welding manual</b>	
ROWELD P110	288
ROWELD P160 SANILINE	290
ROWELD P250A	292
<b>Electrofusion welding</b>	
Electrofusion welding units	294-295
<b>Socket welding</b>	
Socket welding units/heating plates	296-299
<b>Accessories</b>	
Cutting tools	300-303





**Butt welding hydraulic**

	Type Premium CNC	Type Professional	Type Standard	Workshop machines	
					
Suited for	PE, PP, PVDF	PE, PP, PVDF	PE, PP, PVDF	PE, PP, PVDF	
Outer pipe diameter	90–630 mm	40–1,200 mm	40–1,200 mm	90–630 mm	
Operation mode	Automatic CNC controlled	Manual	Manual	Manual	Automatic
Documentation	●	○	○	○	●
<b>Page</b>	<b>282</b>	<b>283</b>	<b>284</b>	<b>286</b>	

**Butt welding manual**

	ROWELD P250A	ROWELD P160	ROWELD P110
			
Suited for	PE, PP, PVDF	PE, PP, PVDF	PE, PP, PVDF
Outer pipe diameter	40–250 mm	40–160 mm	40–110 mm
Wall thickness	see technical data	see technical data	see technical data
Operation mode	Manual	Manual	Manual
<b>Page</b>	<b>292</b>	<b>290</b>	<b>289</b>

**Electrofusion welding**

	ROFUSE 1200 TURBO	ROFUSE 400 TURBO	ROFUSE TURBO S	ROFUSE SANI 160 / 315
				
Suited for	PE, PP	PE, PP	PE, PP	PE
Outer pipe diameter	Up to Ø 1,200 mm <sup>1</sup>	Up to Ø 400 mm <sup>1</sup>	Up to Ø 160 mm <sup>1</sup>	40–160 mm <sup>1</sup> / 40–315 mm <sup>1</sup>
Fitting type	Pressure pipe systems	Pressure pipe systems	Pressure pipe systems	Drainage pipe systems
Voltage	8–48 V	8–48 V	8–48 V	230 V
Documentation	●	●	●	○
<b>Page</b>	<b>294</b>	<b>294</b>	<b>294</b>	<b>295</b>

## Socket welding

## ROWELD P125



## ROWELD P63 S-6 Sword



Suited for	PE, PP	PE, PP
Outer pipe diameter	16–125 mm	20–63 mm
Wall thickness	see technical data	see technical data
Operation mode	Manual	Manual
Function	Butt welding, socket welding	Socket welding
<b>Page</b>	<b>298</b>	<b>296</b>

## Socket welding

## Heating element HE 120



## Heating element HE 200



## Heating element HE 300



Suited for	PE, PP, PVDF	PE, PP, PVDF	PE, PP, PVDF
Outer pipe diameter	Up to Ø 120 mm	Up to Ø 200 mm	Up to Ø 300 mm
Wall thickness	see technical data	see technical data	see technical data
Operation mode	Manual	Manual	Manual
<b>Page</b>	<b>299</b>	<b>299</b>	<b>299</b>

## Cutting

## Peeling device



## ROCUT UKS 160/355



## ROCUT XL



Suited for	PE, PP	PE, PP, PVC	PE
Outer pipe diameter	20–800 mm	160–355 mm	32–315 mm
Wall thickness	–	Up to max. 40 mm	Up to max. 18 mm
Operation mode	Manual	Electrical	Manual
Function	Peeling	Cutting	Cutting
<b>Page</b>	<b>300</b>	<b>302</b>	<b>303</b>

**The new generation of ROWELD hydraulic controls for butt welding**

The ROWELD hydraulic butt welding machine is available in a Premium CNC, Professional and Standard Version.

**Everything at a glance ...**

	Type Premium CNC	Type Professional	Type Standard
<b>Operation</b>	automatic	manual	manual
<b>Available sizes</b>	90–630 mm	40–1,200 mm	40–1,200 mm
<b>Pressure display</b>	digital	analogue	analogue
<b>Temperature control</b>	optimized <sup>1</sup>	optimized <sup>1</sup>	standard
<b>Clamping system</b>	single	single	multilayer (single optional)
<b>Service</b>	extended	extended	standard <sup>2</sup>
<b>Datalogging</b>	10,000 protocols	○	optional
<b>Accordance to normatives</b>	DVS/ISO	DVS/ISO	○
<b>Weight optimized machine</b>	●	●	○
<b>Optimized power consumption for generator use</b>	●	●	○
<b>Automatic parameter calculation</b>	●	○	○
<b>CNC-control</b>	●	○	○

1) Temperature control +/- 5°C  
 2) Only spare parts





**Special features ...**



Fig. similar



**Type Premium CNC**

- Lightweight frame and longlife components.
- Triple coating of heating elements for a longer lifetime and better heat distribution.
- Simple operation Via touch control panel.
- Full documentation of the welding process.

**Type Professional**

- Lightweight frame and longlife components.
- Triple coating of heating elements for a longer lifetime and better heat distribution.

**Type Standard**

- Timer and temperature controller integrated in hydraulic.
- Angled frame.



**Butt welding workshop machines**

**Scope of application:**

The ROTHENBERGER butt welding workshop machines can be used to process pipes made of PE, PP and PVDF into T-pieces, bends, angles or Y-pieces. They are available with both manual control and CNC control. In addition to logging the welding parameters, the CNC control also enables consistent, continuously good quality of the welds.

**Application Benefits:**

Due to the torsionally rigid design, the welding forces are transmitted safely. The precise control of the welding forces as well as the electronic adjustment of the heating element temperature enable welding according to DVS 2207 or other international standards and guidelines. The compact design of the machines require a minimum space requirement with maximum possibilities for the production of molded parts.

12



## ROWELD type Premium CNC

### Hydraulic butt-welding machine Ø 90–630 mm

The PREMIUM hydraulic system guides the user step by step through the welding process and automatically logs all welding parameters. Welding can be performed according to DVS 2207 as well as other international standards and guidelines. The data transfer is carried out via USB interface.

#### Working range:

Description	Ø mm
P250B SA	90–250 mm
P250B VA	90–250 mm
P355B SA	90–355 mm
P355B VA	90–355 mm
P500B SA	200–500 mm
P630B SA	315–630 mm

#### Application Benefits

- Use of durable materials in lightweight construction
- Automatic logging of the welding process
- Easy handling due to touch control panel

#### Flexible

The 3rd basic clamping element can be moved flexibly



Set P355B  
No. 1000000563

#### Robust, torsionally rigid frame

Allows reliable weldings in Virtually any environment

#### Simple operation

Ideally matched components allow precise start-up of the pressure



Simple operation via touch control panel



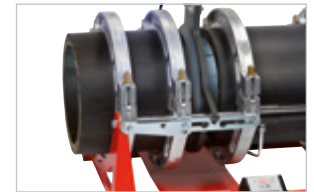
Trimmer with safety switch. Secures against unintended activation of the trimmer



Safe operation—automatic calculation, control and inspection of the welding parameters



The pull-off fixture allows rapid lifting out of the heating element



## ROWELD plastic pipe welding machines type Premium CNC<sup>1</sup>

Model	Working range	Voltage	Frequency	Power	Weight	No.
ROWELD P250B Premium CNC SA basic set	90–250 mm	230 V	50 Hz	3.2 kW	125.900 kg	1000000560
ROWELD P250B Premium CNC SA basic set	90–250 mm	230 V	60 Hz	3.2 kW	125.900 kg	1000000884
ROWELD P250B Premium CNC VA basic set	90–250 mm	230 V	50 Hz	3.2 kW	132.900 kg	1000000561
ROWELD P250B Premium CNC VA basic set	90–250 mm	230 V	60 Hz	3.2 kW	132.900 kg	1000000885
ROWELD P355B Premium CNC SA basic set	90–355 mm	230 V	50 Hz	4.2 kW	131.800 kg	1000000563
ROWELD P355B Premium CNC SA basic set	90–355 mm	230 V	60 Hz	4.2 kW	131.800 kg	1000000886
ROWELD P355B Premium CNC VA basic set	90–355 mm	230 V	50 Hz	4.2 kW	148.400 kg	1000001081
ROWELD P355B Premium CNC VA basic set	90–355 mm	230 V	60 Hz	4.2 kW	148.400 kg	1000001082
ROWELD P500B Premium CNC SA basic set	200–500 mm	400 V	50/60 Hz	7.2 kW	389.000 kg	1000000565
ROWELD P630B Premium CNC SA basic set	315–630 mm	400 V	50/60 Hz	11.2 kW	526.000 kg	1000000567

<sup>1</sup>) ROWELD basic sets consist of: The basic unit with high-pressure hoses and 4 base clamping units, an hydraulic device, heating element, milling device, adjusting box, set of tools and transport box. The desired reduction clamping elements can be ordered separately in the desired size or as a set for the respective machine size.

## ROWELD type Professional

### Hydraulic butt welding machine Ø 40–1,200 mm

For butt welding of PE, PP and PVDF pipes and fittings on the construction site, in the pipe trench and in workshops. The hydraulic system with infinitely variable pressure adjustment, pressure accumulator and easy-to-read pressure gauge ensures reliable operation through the use of durable and low-maintenance components.

#### Working range:

Description	Ø mm
P160B	40–160 mm
P200B	63–200 mm
P250B	90–250 mm
P355B	90–355 mm
P500B	200–500 mm
P630B	315–630 mm
P800B	500–800 mm
P1200B	710–1,200 mm



Fig. similar

#### Simple operation

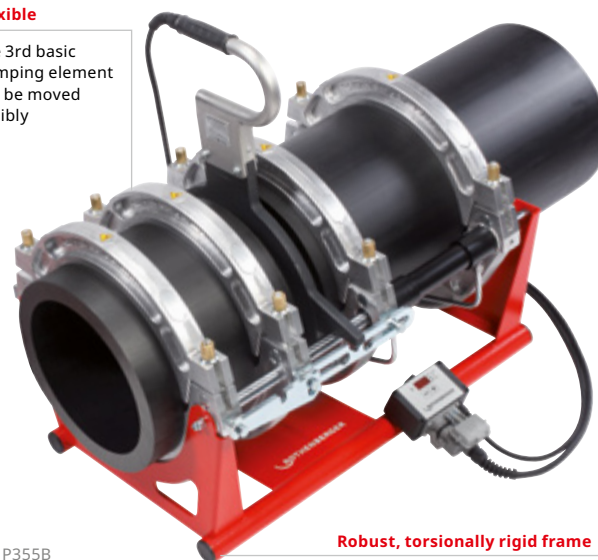
Ideally matched components allow precise start-up of the pressure

### Application Benefits

- Use of durable materials in lightweight construction
- Robust and low-maintenance compact design
- Electronic control of the heating element temperature

#### Flexible

The 3rd basic clamping element can be moved flexibly

Set P355B  
No. 1000000383

#### Robust, torsionally rigid frame

Allows reliable weldings in Virtually any environment

## ROWELD plastic pipe welding machines type Professional<sup>1)</sup>

Model	Working range	Voltage	Frequency	Power	Weight	No.
ROWELD P160B Professional basic set	40–160 mm	230 V	50 Hz	2.1 kW	76.600 kg	1000000997
ROWELD P160B Professional basic set	40–160 mm	230 V	60 Hz	2.1 kW	76.300 kg	1000000823
ROWELD P200B Professional basic set	63–200 mm	230 V	50 Hz	2.3 kW	64.800 kg	55391
ROWELD P200B Professional basic set	63–200 mm	230 V	60 Hz	2.3 kW	64.400 kg	1000000863
ROWELD P250B Professional basic set	90–250 mm	230 V	50 Hz	2.9 kW	120.400 kg	1000001080
ROWELD P250B Professional basic set	90–250 mm	230 V	60 Hz	2.9 kW	120.000 kg	1000000864
ROWELD P355B Professional basic set	90–355 mm	230 V	50 Hz	3.9 kW	126.300 kg	1000000383
ROWELD P355B Professional basic set	90–355 mm	230 V	60 Hz	3.9 kW	125.900 kg	1000000824
ROWELD P500B Professional basic set	200–500 mm	400 V	50 Hz	6.5 kW	377.000 kg	53415
ROWELD P500B Professional basic set	200–500 mm	230 V	50 Hz	7.8 kW	241.400 kg	53425
ROWELD P500B Professional basic set	200–500 mm	230 V	60 Hz	7.7 kW	240.000 kg	1000000820
ROWELD P500B Professional basic set	200–500 mm	400 V	60 Hz	6.4 kW	375.000 kg	1000000825
ROWELD P630B Professional basic set	315–630 mm	400 V	50 Hz	11.1 kW	527.000 kg	53355
ROWELD P630B Professional basic set	315–630 mm	400 V	60 Hz	11.0 kW	525.000 kg	1000000865
ROWELD P800B Professional basic set	500–800 mm	400 V	50/60 Hz	18.6 kW	747.000 kg	54190
ROWELD P1200B Professional basic set	710–1,200 mm	400 V	50/60 Hz	22.6 kW	1,210.000 kg	54274

<sup>1)</sup> ROWELD basic sets consist of: The basic unit with high-pressure hoses and 4 base clamping units, an hydraulic device, heating element, milling device, adjusting box, set of tools and transport box. The desired reduction clamping elements can be ordered separately in the desired size or as a set for the respective machine size.

## Plastic pipe welding

### Butt welding

## ROWELD type Standard

### Hydraulic butt welding machine Ø 40–1,200 mm

For butt welding of PE, PP, and PVDF pipes and fittings. For use on the construction site, in pipe trenches, on pipe bridges and in workshops. The ROWELD hydraulic type standard with simple robust components and easy to operate elements works in any environment.

#### Working range:

Description	Ø mm
E160B	40–160 mm
E250B	90–250 mm
E315B	160–315 mm
E355B	160–355 mm
E450B	200–450 mm
E500B	200–500 mm
E630B	315–630 mm

Other sizes on request.

### Application Benefits

- Compact, torsion-resistant design
- Reducers in sandwich construction
- Integrated digital timer and temperature display in hydraulic housing

#### Flexible

The 3rd basic clamping element can be moved flexibly



#### Robust, torsionally rigid frame

Allows reliable weldings in Virtually any environment

#### Simple operation

Easy monitoring of all necessary parameter



Supply of power for heating element and trimmer unit by the hydraulic. Additional plugs for external data logger (optional accessories)



Simple & save monitoring of all necessary welding parameters



Multilayer-inserts for the needed pipe sizes included in the machine sets



Angled frame sizes 450 / 500 / 630 mm ensure a better handling during the welding process



12

## ROWELD plastic pipe welding machines type Standard<sup>1</sup>

Model	Working range	Voltage	Frequency	Power	Weight	No.
ROWELD E160B Standard set	40–160 mm	220 V	50 Hz	2.45 kW	57.400 kg	1000003642
ROWELD E250B Standard set	90–250 mm	220 V	50 Hz	3.85 kW	82.200 kg	1000003643
ROWELD E315B Standard set	160–315 mm	220 V	50 Hz	4.45 kW	124.400 kg	1000003644
ROWELD E355B Standard set	160–355 mm	220 V	50 Hz	5.58 kW	140.700 kg	1000003645
ROWELD E450B Standard set	200–450 mm	380 V	50 Hz	8.38 kW	327.000 kg	1000003646
ROWELD E500B Standard set	200–500 mm	380 V	50 Hz	9.50 kW	482.000 kg	1000003647
ROWELD E630B Standard set	315–630 mm	380 V	50 Hz	12.35 kW	502.000 kg	1000003648

<sup>1</sup>) ROWELD standard sets consist of: The basic unit with high-pressure hoses and 4 base clamping units, an hydraulic device, heating element, milling device, adjusting box, set of tools, multilayer inserts and transport box.

## Reduction inserts sets

The reduction clamp sets are made of aluminum half shells. When needed they will be fixed in the basic clamps by screws to weld pipes and fittings with smaller diameter

Reducer clamp sets are recommended for all workers who need the complete range of reducer clamps. The set includes 6 wide half shells and 2 small half shells per dimension. They are suitable for gas, water and industrial applications

### Application Benefits

- Easy reducing the basic clamps by reducer inserts
- All possible reducer inserts are combined in a set



Reduction clamp sets



Reduction clamps wide



Reduction clamps small

Model	Weight	PU	No.
Reduction inserts set for P160B 40–140 mm	18.050 kg	1	55240
Reduction inserts set for P200B 63–180 mm	11.500 kg	1	55237
Reduction inserts set for P250B 90–225 mm	14.600 kg	1	55241
Reducer-Clamps set for P355B 90–140 mm	31.000 kg	1	1000000550
Reducer-Clamps set for P355B 160–315 mm	70.000 kg	1	1000000385
Reduction inserts set for P500B 200–450 mm	250.000 kg	1	55234
Reduction inserts set for P630B 315–560 mm	213.000 kg	1	55232
Reducer-Clamps set for P800B 500–710 mm	503.200 kg	1	1000000935
Reducer-Clamps set for P1200B 710–1,000 mm	1,384.000 kg	1	1000000936

### Butt welding workshop machines

**ROWELD butt welding workshop machines are suitable to manufacture T-pieces, Y-pieces, crosses and elbows. Useable materials are PE, PP and PVDF**

They are available with both manual control and CNC control. In addition to logging the welding parameters, the CNC control also enables consistent, continuously good quality of the welds.

#### Application Benefits

- Safe transfer of welding forces thanks to the torsion-resistant structure
- Welding in accordance with DVS 2207 through electronic adjustment of the heating element temperature
- The compact design of the machines requires minimal space



Production of a Y-piece on a workshop machine

**Exchange of the clamping jaws possible**

Easy to make T-pieces, Y-pieces, crosses and elbows

#### CNC controlled welding

Entering the pipe parameters via touch display



**Swivel arm for control**

Makes checking the weld easier



Production of an angle with a CNC-controlled CNC machine



Manual workshop machine with tool and reducers



Machine for workshop W315



Machine for workshop W500



Machine for workshop W800

Figures similar

Technical Data	W315	W500	W800
Working area diameter mm	90–315 mm	200–450 mm	45–800 mm
Power	7.250 KW	17.400 KW	47.230 KW
Voltage	380 V, 50 Hz	380 V, 50 Hz	380 V, 50 Hz
Working area Temperature	< 270 °C	< 270 °C	< 270 °C

Model	Weight	PU	No.
Machine for workshop W315	884.000 kg	1	1500004038
Machine for workshop W500	3510.000 kg	1	1500004345
Machine for workshop W800	4900.000 kg	1	1500003965

Further sizes on request

## Plastic pipe welding

### Butt-fusion welding

#### ROWELD P110

##### Manual plastic pipe welding machine $\varnothing$ 40–110 mm.

The ROWELD P110 combines a compact design for maximum stability. The high quality and excellent workmanship are noticeable in every detail. Hardened and hard-chrome-plated guide shafts guarantee an absolutely torsion-resistant use of the machine. Thanks to the angle-adjustable basic clamping elements, segmental arc welding is also possible.

##### Application Benefits

- Possibility to produce segmented bends
- Precise force adjustment.
- One- and two-sided planing possible
- To do pipe and fitting joints
- Secure fixing and simple axial alignment of the pipe

##### Technical Data

Input power	800 W
Voltage	220–240 V
Working range	40–110 mm
Working area Temperature	160–285 °C
Power plug type	Plug type F (CEE 7 / 4)
Mains frequency	50 / 60 Hz
Welding material	PE, PP, PVDF



##### Narrow basic clamping elements can be used

Segmented bends can be produced

##### Mechanical stop adjustable from both sides

Single and double-sided trimming possible

##### Hardened, chrome-plated guide shafts

Absolutely warp-resistant

##### Wide aluminium reducer clamp inserts for pipes and pipe joints

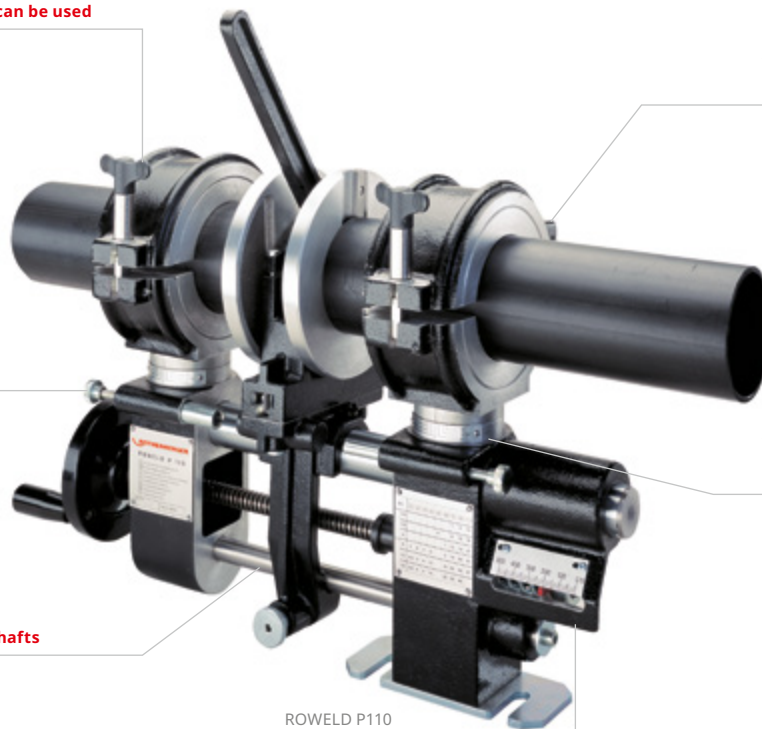
Secure hold and simple axial pipe alignment

##### Angles of the wide basic clamping elements adjustable on both sides (15° each)

Segmented bends can be produced

##### Direct force transmission and clear force scale

Precise pressure adjustment



ROWELD P110

Rectangular heating element



Joints between fittings and pipes with narrow and wide clamping elements



By adjusting the basic clamping element angles on both sides (15° each side) segmented bends can be produced





**ROWELD P110**

Model	Weight	PU	No.
ROWELD P110 set 40–110 mm, 230V	43.000 kg	1	55844
ROWELD P110 bare tool with table mounting bracket	6.800 kg	1	55787

**Basic clamping set**

Model	Weight	PU	No.
Basic clamping set for narrow fitting joints, right, 110 mm, 1 piece	1.000 kg	1	55809
Basic clamping set for narrow fitting joints, left, 110 mm, 1 piece	1.000 kg	1	55808
Basic clamping set for wide pipe joints, 110 mm, 2 pieces	2.500 kg	1	55807

**Reduction inserts**

Model	Weight	PU	No.
Reduction inserts narrow, 2 metal half-shells, 20 mm	0.600 kg	1	55319
Reduction inserts narrow, 2 metal half-shells, 25 mm	0.600 kg	1	55134
Reduction inserts narrow, 2 metal half-shells, 32 mm	0.500 kg	1	55133
Reduction inserts narrow, 2 metal half-shells, 40 mm	0.500 kg	1	55132
Reduction inserts narrow, 2 metal half-shells, 50 mm	0.500 kg	1	55131
Reduction inserts narrow, 2 metal half-shells, 56 mm	0.500 kg	1	55130
Reduction inserts narrow, 2 metal half-shells, 63 mm	0.500 kg	1	55129
Reduction inserts narrow, 2 metal half-shells, 75 mm	0.400 kg	1	55128
Reduction inserts narrow, 2 metal half-shells, 90 mm	0.300 kg	1	55127
Reduction inserts wide, 4 aluminium half-shells, 20 mm	1.900 kg	1	55318
Reduction inserts wide, 4 aluminium half-shells, 25 mm	1.900 kg	1	55126
Reduction inserts wide, 4 aluminium half-shells, 32 mm	1.800 kg	1	55125
Reduction inserts wide, 4 aluminium half-shells, 40 mm	1.700 kg	1	55124
Reduction inserts wide, 4 aluminium half-shells, 50 mm	1.700 kg	1	55123
Reduction inserts wide, 4 aluminium half-shells, 56 mm	1.600 kg	1	55122
Reduction inserts wide, 4 aluminium half-shells, 63 mm	1.400 kg	1	55121
Reduction inserts wide, 4 aluminium half-shells, 75 mm	1.600 kg	1	55120
Reduction inserts wide, 4 aluminium half-shells, 90 mm	1.100 kg	1	55119

**Accessories**

Accessories	Weight	PU	No.
Hex key KW 8 DIN912	0.050 kg	1	321218
Hex key KW 6 DIN911	0.030 kg	1	321216
Transport box	14.200 kg	1	55832
Flange adaptor clamping unit	1.500 kg	1	55199
Table clamp	0.700 kg	1	55524
Heating plate for P110 electronic, 230V	2.600 kg	1	55324
Spare blade for planer	0.050 kg	1	55152
Hand plane with machine holder	1.900 kg	1	55826

## Plastic pipe welding

### Butt-fusion welding

## ROWELD P160 SANILINE

### Manual sanitary plastic pipe welding machine Ø 40–160 mm

The P160 Saniline is ideal for the installer. Due to the compact design, she can be stored in each Vehicle. The heating element has an electronic temperature control (DVS compliant) and can be used separately if necessary



#### Application Benefits

- High stability due to optimized force distribution
- All common sanitary installation fittings can be clamped.
- Flexible use in difficult positions caused by removable heating plates.
- Minimized drag force.
- Precise force adjustment.
- Protection against unintentional starting and derailing of the trimmer unit.
- Secure clamping of pipes, fittings, tight 45° branches and 90° bends

#### Technical Data

Input power	1,850 W
Voltage	220–240 V
Working area diameter	40–160 mm
Working area Temperature	5–60 °C
Power plug type	Plug type F (CEE 7 / 4)
Mains frequency	50 Hz

#### Multiple clamping options

Any fitting in sanitary installations can be clamped

#### Non-slip clamping devices Ø 40–140 mm with clamping force regulation

Secure clamping of pipes, fittings and tight elbows

#### Stop adjustable on both sides

Trimming of both sides, also separately only one side trimming possible

#### Direct force transmission and clear force scale

Precise force adjustment



ROWELD Saniline No. 54004

#### ROCASE 4414

Additional space for tools and accessories

**ROWELD P160 SANILINE**

Model	Weight	PU	No.
ROWELD P160 Saniline, basic tool	34.400 kg	1	54005
ROWELD P160 Saniline Special Edition, 40–160 mm	68.000 kg	1	54004

**Basic clamping set**

Model	Weight	PU	No.
Basic clamping set 160 mm	1.600 kg	1	54082

**Reduction inserts**

Model	Weight	PU	No.
Reduction inserts 4 half-shells, 40 mm	1.600 kg	1	54083
Reduction inserts 4 half-shells, 50 mm	1.600 kg	1	54084
Reduction inserts 4 half-shells, 56 mm	1.600 kg	1	54085
Reduction inserts 4 half-shells, 63 mm	1.600 kg	1	54086
Reduction inserts 4 half-shells, 75 mm	1.600 kg	1	54087
Reduction inserts 4 half-shells, 90 mm	1.600 kg	1	54088
Reduction inserts 4 half-shells, 110 mm	1.700 kg	1	54089
Reduction inserts 4 half-shells, 125 mm	1.500 kg	1	54090
Reduction inserts 4 half-shells, 140 mm	1.500 kg	1	54091



ROWELD SANILINE P160 bare tool

Accessories	Weight	PU	No.
Planer blade 75 mm, 2 pieces	0.100 kg	1	55685
Planer blade carbide 75 mm, 2 pieces	0.050 kg	1	55684
Planer attachment 40–75 mm	0.630 kg	1	54040
Conversion Kit 40–50–63–75–90–110–125–160 mm	11.200 kg	1	54080

## ROWELD P250A

### Plastic pipe welding machine Ø 40–250 mm

For use at construction sites and in the workshop. Particularly suited for sanitary installations, drain pipe laying as well as chimney reconditioning with PVDF liners



#### Application Benefits

- Versatile for difficult situations with the removable heating plates
- Protects against unintentional starting and derailing of the trimmer unit
- Single and double-sided trimming possible
- Warp-resistant for minimum drag and low pressure transfer loss
- Precise welding pressure adjustments on the clear force scale
- Reliable, warp-resistant transfer of the welding pressure
- Stable working table always available

#### Technical Data

Input power	2,700 W
Voltage	230 V
Working area diameter	40–250 mm
Working area Temperature	5–60 °C
Power plug type	Plug type F (CEE 7 / 4)
Documentation	Yes
Mains frequency	50 Hz
Welding material	PE, PP, PVDF

**Electric, high torque safety trimmer (450W) with safety lock in working area**

Protection against unintentional start and jump-out

**Heating element, can be taken out**

Flexible, for difficult positions

**Basic clamp devices Ø 250 mm with reducer clamps Ø 180–225 mm and supports as well as basic clamp devices Ø 160 mm with reducer clamps Ø 40–140 mm and supports**

Secure transfer of welding force

**Stop adjustable on both sides**

Trimming of both sides, also separately only one side trimming possible



ROWELD P250A

**Smooth-running machine slide mounted on hardened, chrome-plated guide shafts guided in ball bushings**

Torsionally stiff, for minimum drag pressure and low-loss power transmission

**ROWELD P250A**

Model	Weight	PU	No.
ROWELD P250A set 40–250 mm, 230 V	131.000 kg	1	55795
ROWELD P250A bare tool 230 V	36.100 kg	1	55768
ROWELD P250A bare tool 110 V	63.000 kg	1	55738

**Basic clamp sett**

Model	Weight	PU	No.
Basic clamping set 160 mm	7.250 kg	1	55742

**Reduction inserts**

Model	Weight	PU	No.
Reduction inserts 4 metal half-shells, 32 mm	1.890 kg	1	55753
Reduction inserts 4 metal half-shells, 40 mm	1.890 kg	1	55752
Reduction inserts 4 metal half-shells, 50 mm	1.810 kg	1	55751
Reduction inserts 4 metal half-shells, 56 mm	1.830 kg	1	55750
Reduction inserts 4 metal half-shells, 63 mm	1.750 kg	1	55749
Reduction inserts 4 metal half-shells, 75 mm	1.680 kg	1	55748
Reduction inserts 4 metal half-shells, 90 mm	1.500 kg	1	55747
Reduction inserts 4 metal half-shells, 110 mm	1.260 kg	1	55746
Reduction inserts 4 metal half-shells, 114 mm	1.200 kg	1	55745
Reduction inserts 4 metal half-shells, 125 mm	1.060 kg	1	55744
Reduction inserts 4 metal half-shells, 140 mm	0.800 kg	1	55743
Reduction inserts 4 metal half-shells, 180 mm	2.460 kg	1	55721
Reduction inserts 4 metal half-shells, 200 mm	2.030 kg	1	55718
Reduction inserts 4 metal half-shells, 225 mm	1.410 kg	1	55719



**ROWELD ROFUSE TURBO**

**Electrofusion welding machine for fittings made of PE and PP. Welding Voltage between 8–48 V.**



The ROFUSE TURBO is especially suitable for electro-fusion welding coded fittings in the pressure systems (gas and water supply).

**Application Benefits**

- Safe: Full automatic Heat-Control (HC) Function ensures with ambient temperature, machine temperature and fitting data whether the fitting can be weld completely for sure
- Powerful: Due to the Active-Cooling (AC) Function the machine is suitable for continuous operation
- Fully equipped : All necessary cable are stowed safely in the robust housing. Additional there is space for some tools and accessory
- Professional Documentation: Safe and transfer (USB) of welding data, as well as print out at a computer with "RODATA 2.0"
- Barcode Generator: "RODATA 2.0" prepares barcodes for construction site and welders name, which can be used for welding on site

**Technical Data**

Input power	3,600 W
Voltage	220–240 V
Working area diameter	20–1,200 mm
Working area Temperature	-10–60 °C
Output power	3,600 W
Power plug type	Plug type E+F (CEE 7 / 7)
Documentation	Yes
Welding Voltage	8–48 V
Output current	76 A
Welding material	PE, PP

ROFUSE 400 TURBO



**Robust housing**

Cable can be stowed safely

**Adjustable height cover**

Useable as a sun Visor

**Language-neutral instruction**

Easy to use

**Well arranged display**

Intuitive work. Program schedule can be changed individual

**Wireless scanner**

Simple and unlimited handling



ROFUSE TURBO S

12

Model	Weight	PU	No.
ROWELD ROFUSE 400 TURBO	21.500 kg	1	100000999
ROWELD ROFUSE 1200 TURBO	21.500 kg	1	100001000
ROWELD ROFUSE TURBO S	10.000 kg	1	1000004403
Adapter pair FF round, 4 mm	0.040 kg	1	54058

## ROWELD ROFUSE SANI 160 / 315

Universal electrofusion machine for waste-water-fittings up to Ø 315 mm



Universal electrofusion machine for PE fittings of the following manufacturers: 40–160 mm: Geberit, Akatherm-EUR, Coes, Valsir, WAVIN-Duo, Aquatherm and Vulcathene-Euro  
200–315 mm: Valsir, Akatherm, Eurofusion, Geberit and Coes

### Application Benefits

- Micro controller controlled welding machine with automatic compensation of the welding time in dependance of ambient temperature
- Icon-based software with automatic welding parameter recognition
- Visual control of the welding process
- Robust and impact resistant housing

### Technical Data

Input power	1,200–2,500 W
Voltage	180–280 V
Working area diameter	40–315 mm
Working area Temperature	-5–40 °C
Power plug type	Plug type F (CEE 7 / 4)
Documentation	Yes
Output current	5 A
Mains frequency	50 / 60 Hz
Welding material	PE

### Welding also in tight space

90° elbow connectors ensure low installation height

### 3 m welding cable

Big working radius



### Robust housing

Robust

### Clear illuminated display

Visual control of welding process

### Simple and intuitive operation

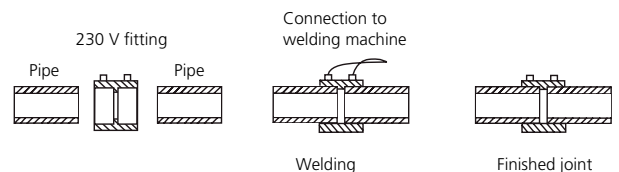
Icon-based software control with automatic welding parameter recognition



90° angled plugs



Robust packaging in ROCASE



Model	Weight	PU	No.
ROWELD ROFUSE SANI 315 230 V	1.500 kg	1	1500002598
ROWELD ROFUSE SANI 315 in ROCASE	3.900 kg	1	1000002631
ROFUSE SANI 160/315 230V, CH	1.200 kg	1	054230Z
ROWELD ROFUSE SANI 160 in ROCASE	2.400 kg	1	1000002630

## ROWELD P63 S-6 Sword

### Socket welder Ø 20–63 mm

socket welder for fittings Ø 20–63 mm. Up to 3 welding combinations are possible at the same time.

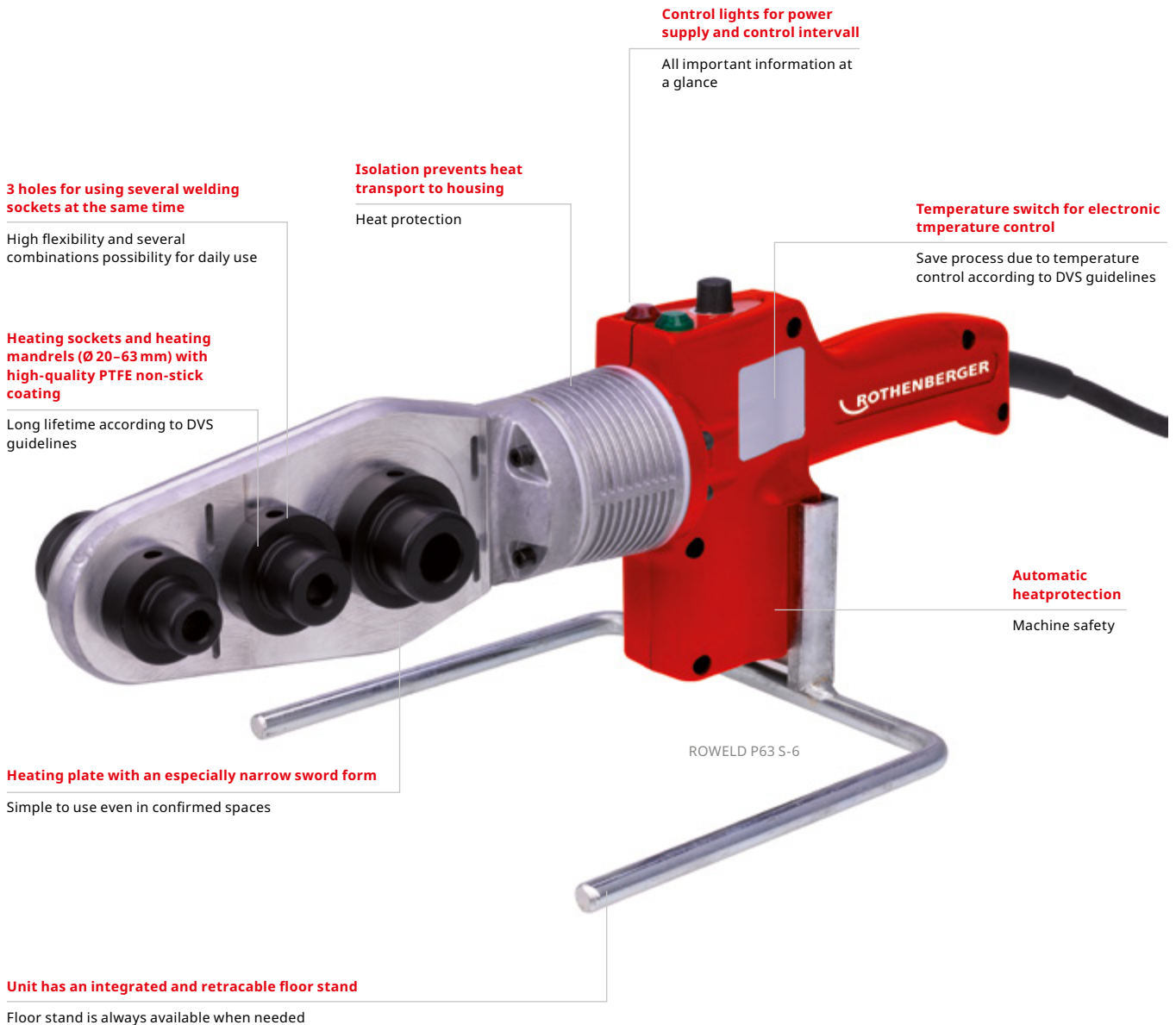
#### Application Benefits

- High flexibility and combination possibilities in daily use
- Long lifetime according to DVS guidelines
- All important informations at a glance
- Process safety due to temperature control according to DVS guidelines
- Smart and handy for easy working
- Simple working at tight space
- Mounting is suitable at every time, if needed



#### Technical Data

Input power	800 W
Voltage	100 V / 230 V
Working area diameter	20–63 mm
Working area Temperature	< 330 °C
Power plug type	Plug Type E+F (CEE 7 / 7)
Mains frequency	50 Hz
Welding material	PE, PP





**ROWELD P63 S-6 Sword**

Model	Weight	PU	No.
ROWELD P63 S-6 Sword set electronic, 20–32 mm, 230 V	4.300 kg	1	053890X
ROWELD P63 S-6 Sword set electronic, 20–63 mm, 230 V	5.300 kg	1	053891X
ROWELD P63 S-6 Sword bare tool electronic, 230 V	1.780 kg	1	053896X
ROWELD P63 S-6 Sword thermostatic, 20–63 mm, 110 V	5.300 kg	1	1000001245
ROWELD P63 S-6 Sword bare tool thermostatic, 230 V	1.780 kg	1	053897X
ROWELD P63 S-6 Sword set thermostatic, 20–32 mm, 110 V	1.780 kg	1	1000001270
ROWELD P63 S-6 Sword set thermostatic, 20–32 mm, 230 V	5.100 kg	1	053892X
ROWELD P63 S-6 Sword set thermostatic, 20–63 mm, 230 V	5.300 kg	1	053893X



Fig. P63 S-6, thermostatically controlled



Fig. P63 S-6, electronically controlled

**Heating spigots and sockets (Form A) for P63 S-6**

With high quality PTFE non-stick-coating for long lifetime in accordance to DVS guidelines

Accessories for ROWELD P125 for socket welding.

**Application Benefits**

- High quality non-stick teflon coating
- Long lifespan
- According to DVS guidelines



Model	Weight	PU	No.
Heating spigots / Heating sockets form A, 20 mm	0.110 kg	1	53511
Heating spigots / Heating sockets form A, 25 mm	0.143 kg	1	53512
Heating spigots / Heating sockets form A, 32 mm	0.188 kg	1	53513
Heating spigots / Heating sockets form A, 40 mm	0.285 kg	1	53514
Heating spigots / Heating sockets form A, 50 mm	0.406 kg	1	53515
Heating spigots / Heating sockets form A, 63 mm	0.775 kg	1	53516

**ROWELD P125**

**Socket welder for Ø 16–125 mm and additional heating plate for butt welding**

With 3 welding combinations at the same time. For freehand working or in addition with mounting device for working bench

**Application Benefits**

- Safe process due to temperature control in accordance to DVS, CEN and ISO standards
- With high quality PTFE non-stick coating, long lifetime in accordance to DVS guidelines
- Electronic temperature control as well as protection against unintentional adjustment of the temperature
- Saving time and costs due to heating plate quick change system
- Optimized temperature all over the working range
- 4 holes for welding socket and mandrels



ROWELD P125 Socket Welder

Heating spigots / Heating sockets



Model	Weight	PU	No.
ROWELD P125 bare tool electronic, 110V	3.100 kg	1	55322
ROWELD P125 bare tool electronic, 230V	3.100 kg	1	55321
ROWELD P125 set elektronik, 63–125 mm, 230V	17.050 kg	1	55546
Adaptor plates with non-stick Teflon coating, 2 pieces	1.150 kg	1	55536
Floor stand	0.440 kg	1	55539

**Heating spigots and sockets for ROWELD P125**

**Socket welding unit for use with heating spigots and heating sockets for Ø 16–125 mm, as well as adaptor plates for butt welding**

With three simultaneously usable welding combinations for free-handed working or workbench assembly using table mounting clamp



Model	Weight	PU	No.
Heating spigots / Heating sockets 16 mm	0.060 kg	1	55585
Heating spigots / Heating sockets 18 mm	0.080 kg	1	55587
Heating spigots / Heating sockets 19 mm	0.080 kg	1	55588
Heating spigots / Heating sockets 20 mm	0.080 kg	1	55589
Heating spigots / Heating sockets 25 mm	0.100 kg	1	55590
Heating spigots / Heating sockets 32 mm	0.170 kg	1	55591
Heating spigots / Heating sockets 40 mm	0.260 kg	1	55592
Heating spigots / Heating sockets 50 mm	0.370 kg	1	55593
Heating spigots / Heating sockets 63 mm	0.600 kg	1	55594
Heating spigots / Heating sockets 90 mm	1.330 kg	1	55596
Heating spigots / Heating sockets 110 mm	2.070 kg	1	55597
Heating spigots / Heating sockets 125 mm	2.330 kg	1	55598

## ROWELD HE heating plates

Butt welding heating element for pipes and fittings made of PE, PP and PVDF with Ø 20-250 mm

Heating elements with high-quality PTFE non-stick coating for flexible working on the pipeline or stationary working on the workbench with table clamp piece



### Application Benefits

- Long lifetime and equipped according to DVS guidelines
- Safe process due to temperature regulation according to DVS, CEN and ISO standards
- Electronic temperature regulation and control as well as protection against unintentional temperature change
- Saves time and costs due to heating plate fast change system



Heating element for freehand work



Model	Weight	PU	No.
Heating plate electronic, 120 mm, 45°, 230 V	1.800 kg	1	55518
Heating plate electronic, 200 mm, 230 V	1.920 kg	1	55316
Heating plate electronic, 300 mm, 230 V	5.350 kg	1	55317
Heating plate electronic, 120 mm, 45°, 110 V	1.800 kg	1	55517
Heating plate electronic, 200 mm, 110 V	1.920 kg	1	55851
Heating plate electronic, 300 mm, 110 V	5.350 kg	1	55854

### Accessories

	No.
Table clamp piece for ROWELD heating element P110 / P125	55524
Floor stand for ROWELD P125	55539
Top plates for P125, 2 pieces	55536

### Peeling device

For safe and quick preparation of pipes and fittings.  
Delivered in a transport box.

#### Application Benefits

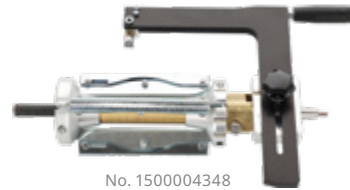
- Spring-loaded blade ensures automatic adaptation to oval tubes
- Long durability thanks to carbide peeling knife
- Automatic feed enables even chip removal
- Easy operation and low effort during the peeling process
- Operation with cordless screwdriver possible (No. 1500004346 und No. 1500004348)



No. 1500004346



No. 1500004347



No. 1500004348



No. 1500004349

Model	Weight	PU	No.
Peeling device, 20–75 mm	2.300 kg	1	1500004346
Peeling device, 90–315 mm	6.900 kg	1	1500004347
Peeling device, 180–400 mm	9.900 kg	1	1500004348
Rotary peeling chain, 200–800 mm	9.600 kg	1	1500004349

### Squeezing device

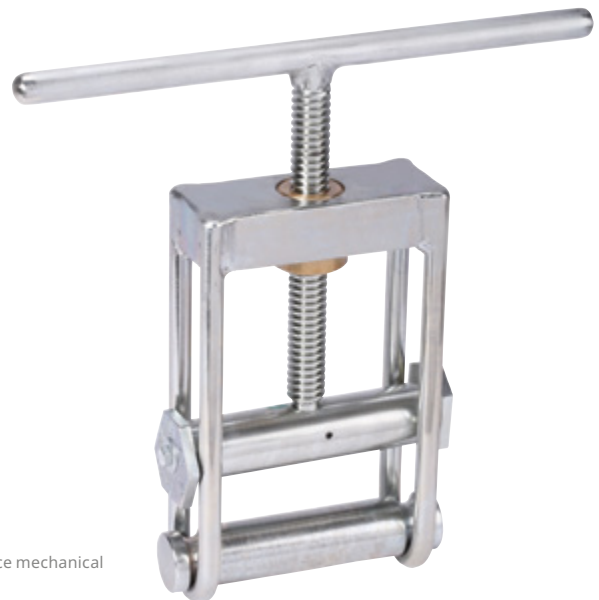
Squeezing device for PE pipes. Spacers on both sides of the device to avoid pipe damages. Due to robust design, ideal for use at construction site

**Mechanical:** working range from Ø 32–63 mm. To protect the squeezed area there are adjustable distance controller beside.

**Hydraulic:** working range from Ø 75–225 mm. To protect the squeezed area there are adjustable distance controller beside. With this device the pipes can re-rounded with separate available re-rounding halfshells.

#### Application Benefits

- Distance plates prevent damage to the pipe on the sides
- Simple robust construction—ideal for use on construction sites



Squeezing device mechanical

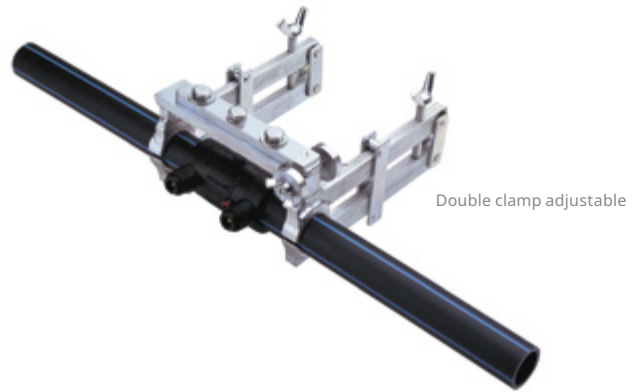
Model	Weight	PU	No.
Squeezing device mechanical, 32–63 mm	5.000 kg	1	53200
Squeezing device hydraulic, 75–180 mm	37.000 kg	1	53210
Squeezing device hydraulic, 160–225 mm	55.600 kg	1	53220

## Clamp device

For fixing pipes and fittings before and whilst welding

### Application Benefits

- Exact alignment of the pipe prior to welding
- Tool-less exchangeable for quick and easy machine retooling



Double clamp adjustable

Model	Weight	PU	No.
Double clamp adjustable, 32 mm	1.500 kg	1	53251
Double clamp adjustable, 40 mm	2.125 kg	1	53252
Double clamp adjustable, 50 mm	2.380 kg	1	53253
Double clamp adjustable, 63 mm	2.520 kg	1	53254

## Double clamp short

For fixing pipes and fittings before and whilst welding

### Application Benefits

- Precise alignment of the pipes before welding
- Fixing of the pipes during the welding process



Double clamp short

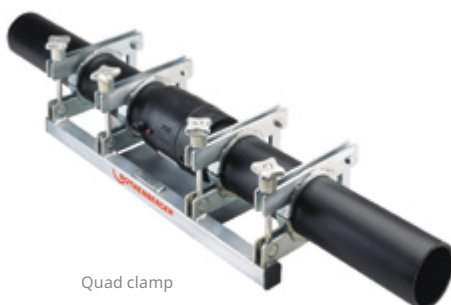
Model	Weight	PU	No.
Double clamp short, 75 mm	3,360 kg	1	53255
Double clamp short, 90 mm	4.465 kg	1	53256
Double clamp short, 125 mm	6.645 kg	1	53258
Double clamp short, 140 mm	6.290 kg	1	53259
Double clamp short, 160 mm	6.870 kg	1	53260
Double clamp short, 180 mm	9.590 kg	1	53261
Double clamp short, 200 mm	13.275 kg	1	53262
Double clamp short, 225 mm	11.150 kg	1	53263

## Quad clamps

For connecting pipes with Ø 63–225 mm

### Application Benefits

- Quadruple clamping device for aligning and fixing the tubes before and during the welding process
- For the production of control joints for bar stock



Quad clamp

Model	Weight	PU	No.
Quad clamp 63 mm	8.000 kg	1	53271
Quad clamp 75 mm	6.265 kg	1	53272
Quad clamp 90 mm	11.000 kg	1	53273
Quad clamp 110 mm	14.000 kg	1	53274
Quad clamp 125 mm	10.140 kg	1	53275
Quad clamp 140 mm	11.300 kg	1	53276
Quad clamp 160 mm	17.000 kg	1	53277
Quad clamp 180 mm	17.000 kg	1	53278
Quad clamp 200 mm	21.690 kg	1	53279
Quad clamp 225 mm	19.200 kg	1	53280

## Plastic pipe welding

Electro-fusion welding / Cutting tools & accessories

### Re-Rounding clamps

For fixing the pipe and re-rounding after squeezing

#### Application Benefits

- Fixing the welding depth during electrofusion welding
- Rounding of the PE pipe after crimping

Model	Weight	PU	No.
Re-Rounding clamp 25 mm	1.111 kg	1	53281
Re-Rounding clamp 32 mm	0.590 kg	1	53282
Re-Rounding clamp 40 mm	1.111 kg	1	53283
Re-Rounding clamp 50 mm	0.835 kg	1	53284
Re-Rounding clamp 63 mm	1.000 kg	1	53285



Re-Rounding clamp

### ROCUT UKS 160 / 355

High performance orbital circular saw

For cutting plastic pipes made of PE, PP and PVC at construction site and workshop

#### Application Benefits

- Offset-free and right-angled cutting
- Efficient working, high speed cutting
- Safety work due to sawblade protection
- Optimal pipe centering

#### Technical Data

Input power	1,750 W
Voltage	230 V
Working area diameter	160–355 mm
Power plug type	Plug type F (CEE 7 / 4)
Mains frequency	50 / 60 Hz



#### Sawblade protection

Safe operation

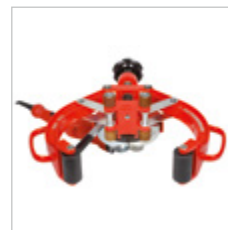


Circular saw

#### Central clamping

Perfect pipe centering

Four rubberised clamping and guide rollers ensure right-angled cuts with no misalignment



Secure clamping and optimum pipe centering are guaranteed by the central trapezoidal clamping device



#### Rubberised guide rollers

Right-angled cuts with no misalignment

Model	Weight	PU	No.
ROCUT UKS 160 / 355	12.900 kg	1	100000532
Spare HM saw blade 180 × 30 mm	0.600 kg	1	55505
Transport box	16.800 kg	1	120000526

## ROCUT XL

**For cutting PE pipes in the trench.  
For repairs and extensions.**

Tool for cutting PE pipes up to 315 mm

### Application Benefits

- Can be used on each place of the pipe
- Robust cutter made of stainless steel

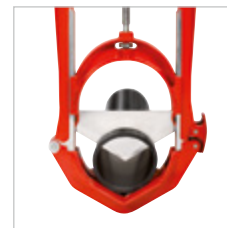
### Technical Data

Working area diameter	< 315 mm
Cutting material	PE

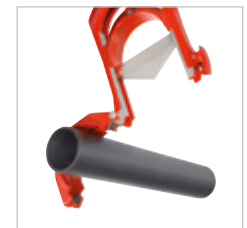


ROCUT XL 125

An optimised cutting angle for easier pipe cutting



The lower clamp can be folded out completely. Therefore, ROCUT XL can be used at any desired position of the pipe



Model	Weight	PU	No.
ROCUT XL 125 mm 4"	7.300 kg	1	1500000789
ROCUT XL 315 mm 12"	34.000 kg	1	1500000792
Spare blade 125 mm	0.270 kg	1	1500000793
Spare blade 315 mm	2.100 kg	1	1500000795

## Plastic pipe chamfering unit

**With replaceable blades Ø 16–160 mm For 15° outer chamfers on plastic pipe**

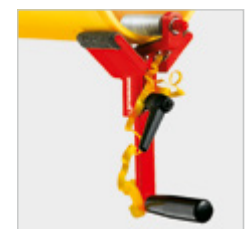
With this tool 15° chamfers can easily be produced on plastic pipes

### Application Benefits

- Flexible in use
- Wall thickness is continuously adjustable



Plastic pipe chamfering unit



Model	Weight	PU	No.
Chamfering unit Size 1, 16–110 mm	0.615 kg	1	55050
Chamfering unit Size 2, 32–160 mm	0.680 kg	1	55051
Spare blade Size 1 and 2	0.030 kg	1	55058










## Refrigeration and air-conditioning technology

<b>System overview</b>	<b>306-307</b>
<b>Complete solutions</b>	
Commissioning and maintenance	308-309
Evacuation and charging	310
<b>Refrigeration circuit control</b>	
Digital manifold	311
Analog manifold	312
Pressure hose	313
<b>Leak testing and locating</b>	
Nitrogen set	314
Leak detection devices	315
<b>Evacuation</b>	
Vacuum pumps	316-318
<b>Recovery and filling</b>	
Refrigerant recovery device	319-320
Refrigerant scale	321
<b>Accessories</b>	
Cleaning, tools and adaptors	322-323
Instructions for the use of refrigerants	324
Conversion tables pressure and temperature	325







**Complete solutions**

	<b>ROKLIMA MULTI 4F</b>	<b>ROCADDY 120 R32 Analog ROCADDY 120 R32 CL Analog</b>	<b>ROCADDY 120 R32 Digital ROCADDY 120 R32 CL Digital</b>
			
Refrigerants class A1 (R134a, R410A etc.)	●	●	●
Refrigerants class A2 (R32, R1234yf etc.)	○	●	●
CO <sub>2</sub> subcritical (R744)	○	○	●
System size	< 24 kW	< 24 kW	< 24 kW
<b>Page</b>	<b>308</b>	<b>310</b>	<b>310</b>



**Refrigeration circuit control**

	<b>ROCOOL 600</b>	<b>2- and 4-ways manifold connection 5/16"</b>	<b>2- and 4-ways manifold connection 1/4"</b>	<b>Pressure hoses</b>
				
Refrigerants class A1 (R134a, R410A etc.)	●	●	●	●
Refrigerants class A2 (R32, R1234yf etc.)	●	●	○	●
CO <sub>2</sub> subcritical (R744)	●	○	○	●
System size	all	all	all	all
<b>Page</b>	<b>311</b>	<b>312</b>	<b>312</b>	<b>313</b>

**Evacuation**

	ROAIRVAC R32 1.5	ROAIRVAC R32 CL 2.0	ROAIRVAC R32 3.0	ROAIRVAC R32 CL 5.0	ROAIRVAC R32 6.0	ROAIRVAC R32 9.0
						
Refrigerants class A1 (R134a, R410A etc.)	●	●	●	●	●	●
Refrigerants class A2 (R32, R1234yf etc.)	●	●	●	●	●	●
CO <sub>2</sub> subcritical (R744)	●	●	●	●	●	●
Cordless	○	●	○	●	○	●
System size	< 24 kW	< 40 kW	< 74 kW	< 100 kW	< 123 kW	< 124 kW
<b>Page</b>	<b>317</b>	<b>316</b>	<b>317</b>	<b>316</b>	<b>317</b>	<b>317</b>

**Recovery**

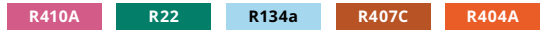
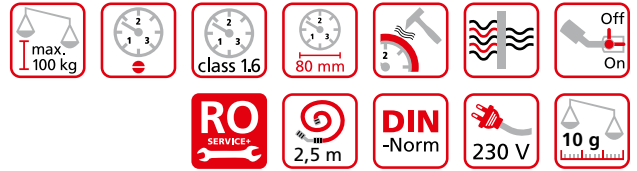
	ROREC	ROREC PRO A3
		
Refrigerants class A1 (R134a, R410A etc.)	●	●
Refrigerants class A2 (R32, R1234yf etc.)	○	●
Refrigerants class A3 (R290, R650a etc.)	○	●
CO <sub>2</sub> subcritical (R744)	○	○
System size	< 24 kW	all
<b>Page</b>	<b>319</b>	<b>320</b>

Complete solutions

**ROKLIMA MULTI 4F**

**Fully automatic commissioning and maintenance of air-conditioning units and heat pumps**

The innovative unit enables safe and comfortable operation on refrigeration systems. With simple menu navigation, 4 functions (4F) are automatically controlled.



**Application Benefits**

- Pressure resistance up to 80 bar guarantees full use with heat pumps
- Everything you need within reach
- Simple menu guidance guarantees appropriate use
- Fully automatic control gives time for parallel work
- Safe transport

**4 functions (4F) in one:**

- Evacuation
- Charging
- Leakage test
- Control of the recovery process

**Technical Data**

Working area pressure	25 micron
Frequency	50 Hz
Voltage	240 V
Working area temperature	-25–50 °C
Connection	Bottle adaptor / 1/4" SAE
Suction volume	42 l/min
Resolution Weighing	10 g
Hose length	2,500 mm

**Sturdy, compact metal casing**

Protects all components such as vacuum pump and scale

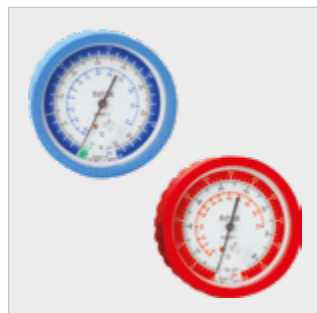
**Integrated high vacuum pump with 42 l/min suction power**

For evacuation of the system in accordance with DIN 8975

**Pull-out precision digital scale up to 100 kg**

Secure stand for large and small containers

Shock-resistant low pressure and high pressure gauges for various refrigerants



Secure storage of all accessories



Pressure hoses: 2.5 m long with shut-off valve



Bottle adaptor No. 173204 / 05 for scale and 1/4" reducing pieces



**Interactive 16-digit display with 4 function buttons**

All required parameters can be easily entered

**3 different pressure gauges "Pulse-free", class 1.6, 80 mm**

Universal use on air-conditioning units with all common refrigerants and operation in the high pressure range with R410A

**2 pressure hoses (2,500 mm) from the series "Plus" with ball valve**

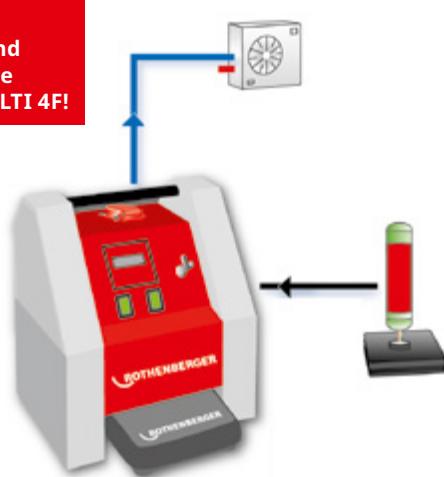
Safe and comfortable operation with refrigerants without the risk of refrigerant loss

**Plastic capillary hose**

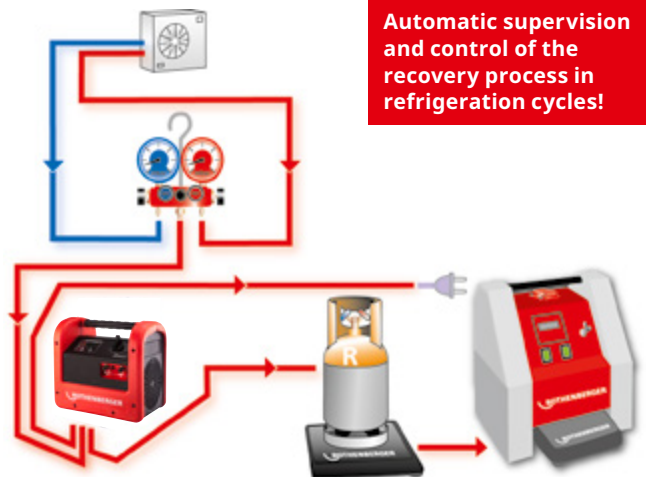
Safe, leak-free filling due to shut-off valve

**ROKLIMA MULTI 4F**

Automatic evacuation and filling with the ROKLIMA MULTI 4F!



Automatic supervision and control of the recovery process in refrigeration cycles!



ROKLIMA MULTI 4F in use (evacuation and charging)



Set (No. 100000138) includes: 2-stage vacuum pump, 2×low pressure gauges, 1×high pressure gauge R410A, 2× pressure hoses with ball valve à 2,500 mm, 2×bottle connection adaptors (1/4" SAE No. 173205, 5/16" SAE No. 173204), 2×reducing pieces 1/4" SAE F-5/16" SAE M (No. 170016), precision digital scale up to 100 kg, automatic control, vacuum and pressure switch, mineral oil (No. 169200)

Model	Weight	PU	No.
ROKLIMA MULTI 4F	17.000 kg	1	100000138
Reducer pieces 1/4" SAE F-5/16" SAE M	0.100 kg	1	170016

Secure storage of accessories: pressure hoses bottle adaptor, plastic capillary hose

Precision scale up to 100 kg  
Resolution: 10 g  
Accuracy: ± 1 %

Ergonomic and compact

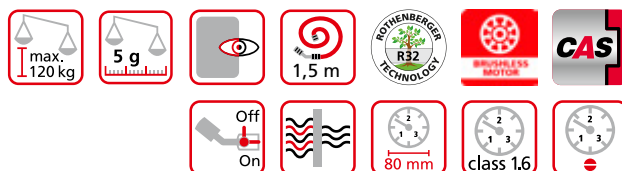
Light



## ROCADDY 120 R32 (CL) Analog / Digital

### Universal sets for evacuation and charging

The universal set ROCADDY is suitable for the installation, maintenance and repair of refrigeration and air conditioning systems and heat pumps.



### Application Benefits

- Everything you need within reach
- Flexible use with the individual use of the tools
- Easy to transport
- Electronic digital scale ROSCALE 120 with a weighing capacity of 120 kg and a measuring accuracy per measuring step of 5 g
- 2-stage high vacuum pump ROAIRVAC (corded / accumulator) with integrated vacuum gauge and solenoid check valve

- Digital installer aid for automatic calculation of superheat and subcooling. More than 80 refrigerants stored in the unit
- 2 analog 4-way installer aids for the common refrigerants R22, R134a, R404A, R407C and the high-pressure refrigerants R410A and R32
- Pressure hose set of 3 PLUS series hoses with shut-off valve for safe working with refrigerants
- TUBE CUTTER 35 and MINICUT II PRO for cutting tubes of diameter 6–35 mm to length

### Flexible application with corded or battery-powered vacuum pump

#### Sturdy plastic rolling case

Simple and comfortable transport with ample room for accessories and small parts

#### 2-stage high vacuum pump

For evacuation and removal of all moisture residue in refrigeration systems during installation per DIN 8975

#### Bottle adaptor for 1 kg and 2 kg refrigerant bottles for connection to the scale

Secure mounting of the bottle during charging

ROCADDY 120 R32 Analog / Digital (No. 1000002560/1000002561) includes: 2-stage vacuum pump ROAIRVAC R32 1.5 (No. 1000002399), 4-way manifold (No. 170502) / 4-way manifold (No. 1000001427) (Analog), ROCOOL 600 (No. 1000000569) / clamping thermometer (No. 1000000540) (Digital), pressure hose set 5/16" SAE 1,500 mm (No. 1500000030), pressure hose set 1/4" SAE 1,500 mm (No. 1500000028), ROSCALE 120 (No. 173004), 3/8" SAE F-1/4" SAE M (No. 89501), 2 x 5/16" SAE F-1/4" SAE M (No. 01700RD), 5/16" SAE M-1/4" SAE F (No. 170016), bottle connection 1/4" (No. 173205), bottle connection 5/16" (No. 173204), mineral oil (0,4l), TUBE CUTTER 35 (No. 70027), MINICUT II PRO (No. 70402), transport case (No. 169051)

Model	Weight	PU	No.
R410A R22 R134a R407C R404A R32			
ROCADDY 120 R32 Analog	20.000 kg	1	1000002560
ROCADDY 120 R32 Digital	19.000 kg	1	1000002561

#### Electronic digital scale up to 120 kg with high measurement precision

Precise weighing of refrigerant



2 x analog manifolds (ROCADDY 120 Analog)

(with ROCADDY 120 CL)

#### Mini tube cutter and pipe cutter

For cutting Ø 6–35 mm pipes to length

#### ROCOOL 600

Automatic calculation of superheat and subcool. Optionally upgradable through attachment of a vacuum probe and a reading out function

ROCADDY 120 R32 CL Analog / Digital (No. 1000003622/1000003623) includes: 2-stage vacuum pump ROAIRVAC R32 2.0 CL (No. 1000003229), 4-way manifold (No. 170502) / 4-way manifold (No. 1000001427) (Analog), ROCOOL 600 incl. clamping thermometer (Digital) (No. 1000000569), pressure hose set 5/16" SAE 1.5 m (No. 1500000030), pressure hose set 1/4" SAE 1.5 m (No. 1500000028), ROSCALE 120 (No. 173004), 3/8" SAE F-1/4" SAE M (No. 89501), 2 x [5/16" SAE F-1/4" SAE M (No. 01700RD), 5/16" SAE M-1/4" SAE F (No. 170016)], bottle connection 1/4" (No. 173205), bottle connection 5/16" (No. 173204), bottle connection for R32 (No. 173206), mineral oil (0,4l), TUBE CUTTER 35 (No. 70027), MINICUT II PRO (No. 70402), 8.0 Ah Li-HD battery (No. 1000002549), charger (No. 1000001654), transport case (No. 169051)

Model	Weight	PU	No.
R410A R22 R134a R407C R404A R507 R32			
ROCADDY 120 R32 CL Analog	21.000 kg	1	1000003622
ROCADDY 120 R32 CL Digital	20.000 kg	1	1000003623

## ROCOOL 600

For commissioning, maintenance work and documentation of refrigeration systems of all kinds



### Application Benefits

- Modular system: The basic device can be fitted with the optional Red Box incl. the Data Viewer software for reading out or recording data on a PC.
- More than 80 refrigerants incl. R32 and R744 (sub-critical) are stored in the device. New refrigerants can be added later using the update function
- Simultaneous calculation of superheat and subcool
- The documentation software Data Viewer generates an automatic report based on the data recorded. Ideal for handing out to the customer (client)
- An external Pirani vacuum probe allows reading of the vacuum where the most precise measurement is possible: directly at the refrigeration system

### Technical Data

Working area pressure	-1-60 bar
Working area Temperature	-10-50 °C
Recording time	96 h
Connection	1/4" SAE
Display size	11 cm

An absolute all-rounder due to the unique modular system!

#### Large screen

All important data at a single glance. Strong backlight for dark environment

#### Connection for the temperature sensor T1

For automatic measurement of superheat data

#### Connection for the external vacuum probe

For very precise measurement of the vacuum level directly at the refrigeration system

#### Pressure sensors "Made in Germany"

Precise measurement from -1 to 60 bar

#### T-connection with Schrader valve 1/4" SAE

3-way function: Evacuation and filling without changing a hose

#### Y-connections 1/4" SAE

A connection and sealing plug in one. Simple transport of hoses when not in operation

- Set (No. 100000569) includes: ROCOOL 600, 1 temperature sensor
- Set (No. 100000570) includes: ROCOOL 600, 2 temperature sensors, carry case
- Set (No. 100000572) includes: ROCOOL 600, 2 temperature sensors, red box and data viewer software, carry case

Model	Weight	PU	No.
ROCOOL 600 Set with 1 temperature sensor, blister	1.495 kg	1	100000569
ROCOOL 600 Set with 2 temperature sensors, case	4.060 kg	1	100000570
ROCOOL 600 Set with 2 temperature sensors, red box, data viewer software, case	4.435 kg	1	100000572

#### Solid and non-tacky rubber coating

Prevents shock damages and allows a safe handling

#### Connection for the temperature sensor T2

For automatic measurement of subcool data

#### Green and red LEDs

An optical signal is displayed once an adequate vacuum level is reached or leakage in the system and also a warning of overpressure

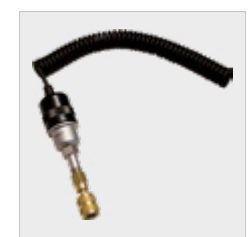
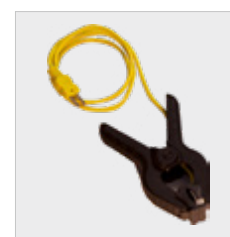
#### Connection of the Red Box

To record data for up to 96 hours and independent read out of data at a PC



Temperature sensor for a pipe diameter of up to Ø 32 mm

External vacuum probe for very precise measurement of the vacuum



- Set (No. 100000539) includes: Red box, data viewer software, connection cable, external power supply

Model	Weight	PU	No.
Red box, software, connection cable, external power supply	0.338 kg	1	100000539
Temperature sensor	0.120 kg	1	100000540
Vacuum probe	0.155 kg	1	100000541

### Analog manifolds

#### 2- and 4-way manifolds

The ROTHENBERGER 4-way manifolds are used for the commissioning and maintenance of air conditioning and refrigeration systems as well as heat pumps

**Pressure gauge Ø 80 mm, with pulse-dampening class 1.6**

Easy-to-read, high precision display

**Large hand valve with color coding**

Light, secure and precise opening and closing of the diaphragm valve, maintenance free

Valve sets

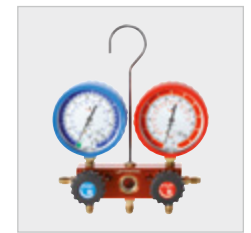
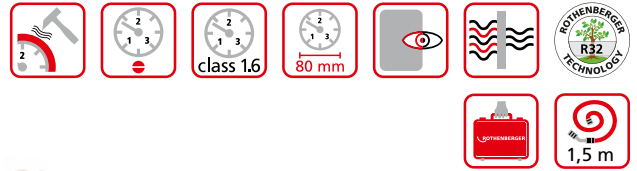


**Pressure gauge with shock-proof rubber protector**

Protects against damage

**Valve body made of aluminium with gauge glass**

Sturdy despite low weight



2-way manifold

Model	Weight	PU	No.
R22 R134a R407C R404A			
2-way, 1/4" SAE, 34 bar	0.700 kg	1	170501
4-way, 1/4" SAE, 34 bar	0.900 kg	1	170502
R410A R32			
2-way, 5/16" SAE, 60 bar	1.010 kg	1	1000001426
4-way, 5/16" SAE, 60 bar	1.105 kg	1	1000001427

Model	No.
Blue rubber protector for manifold	170545
Red rubber protector for manifold	170546
Valve sets for manifold	170547

### Manifold sets

#### Manifold sets and pressure hoses

2-way manifold (for 170600 and 170607)

4-way manifold (for 170601, 170606, 170602 and 170608)

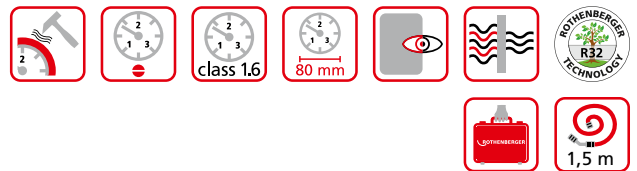
Durable and highly precise tool



No. 170602

**Pressure hose with ball valve "Plus" (only for 170602 and 170608)**

No loss of refrigerant



Scope of delivery: manifold, pressure gauge with Ø 80 mm, "Pulse-free", class 1.6, 3 × 1,500 mm pressure hoses, plastic carrying case

Model	Weight	PU	No.
R22 R134a R407C R404A			
Manifold set 2-way, Standard	2.700 kg	1	170600
R410A R32			
Manifold set 2-way, Standard	2.700 kg	1	170607
R22 R134a R407C R404A			
Manifold set 4-way I, Standard	2.800 kg	1	170601
R410A R32			
Manifold set 4-way I, Standard	2.800 kg	1	170606
R22 R134a R407C R404A			
Manifold set 4-way II, Plus	2.800 kg	1	170602
R410A R32			
Manifold set 4-way II, Plus	2.800 kg	1	170608

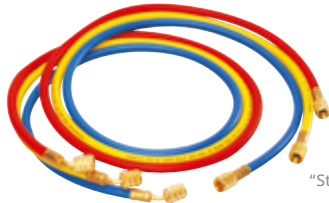


### 3-piece pressure hose sets

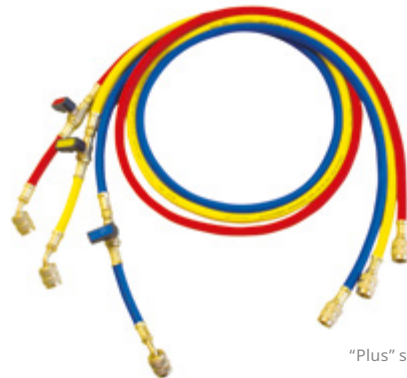
Available in "Standard" and "Plus"

#### Application Benefits

- No confusion and safe use with the colour coding (blue, red, yellow)
- Teflon seal with up to 10× longer service life compared to neoprene seal
- Working pressure 60 bar / burst pressure 300 bar. This is an 8 % better pressure resistance as previously



"Standard" series



"Plus" series

"Standard" series	Weight	PU	No.
Vacuum hose 3/8" SAE, 1.5 m	0.220 kg	1	1500000032
<b>R22</b> <b>R134a</b> <b>R407C</b> <b>R404A</b>			
Set of 3 pressure hoses 1/4" SAE, 1.5 m	0.760 kg	1	1500000024
Pressure hose yellow, 1/4" SAE, 1.5 m	0.250 kg	1	1500000025
<b>R410A</b> <b>R32</b>			
Set of 3 pressure hoses 5/16" SAE, 1.5 m	0.730 kg	1	1500000026
Pressure hose yellow, 5/16" SAE, 1.5 m	0.250 kg	1	1500000027

"Plus" series with ball valve	Weight	PU	No.
<b>R22</b> <b>R134a</b> <b>R407C</b> <b>R404A</b>			
Set of 3 pressure hoses 1/4" SAE, 1.5 m	0.895 kg	1	1500000028
Pressure hose yellow, 1/4" SAE, 1.5 m	0.250 kg	1	1500000029
<b>R410A</b> <b>R32</b>			
Set of 3 pressure hoses 5/16" SAE, 1.5 m	0.840 kg	1	1500000030
Pressure hose yellow, 5/16" SAE, 1.5 m	0.250 kg	1	1500000031

### Tool set Climate I and II

Practical tool set with all tools required

For the installation and maintenance of refrigeration systems and heat pumps

#### Application Benefits

- Monitor temperature and pressure
- Quality hoses with high bursting pressure
- Pipe cutter for all pipe cross-sections from 3–35 mm (1/8"–1.1/8")
- Measurement of ambient and ventilator air temperature
- Clean, kink-free bending of all common pipe cross-sections
- Optimum flaring connections for all types of air-conditioner

Set Climate I (No. 170604) includes: 2-way manifold (No. 170501), set of pressure hoses standard 1/4" SAE, TUBE CUTTER 35 C (No. 070027C), MINICUT pipe cutter (No. 070401C), thermometer, set of bending springs 3/8"–1/2"–5/8", universal flaring tool (No. 222601), plastic case

Set Climate II (No. 170605) includes: 2-way manifold (No. 100001426), set of pressure hoses standard 5/16" SAE, TUBE CUTTER 35 C (No. 070027C), MINICUT pipe cutter (No. 070401C), thermometer, set of bending springs 3/8"–1/2"–5/8", reeling flaring tool (No. 222402), plastic case

Model	Weight	PU	No.
Tool set Climate I	2.300 kg	1	170604
Tool set Climate II	2.400 kg	1	170605

The ideal introduction into a whole new area of business!

**R32** **R22** **R407C** **R404A**



No. 170604

## Nitrogen set

### Multiple uses for refrigeration systems

#### Application Benefits

- Fine scaled 1.0 gauge—precise reading of the testing pressure
- Spring loaded pressure reducing valve—simple and safe handling
- Connection for large bottles—easy connection for bottles of all sizes possible
- 950 cm<sup>3</sup> nitrogen bottle included—complete set



**Ideal for split air-conditioning units and heat pumps!**



950 cm<sup>3</sup> nitrogen bottle included

Complete set

Spring loaded pressure reducing valve

Simple and safe handling

Fine scaled 1.0 pressure gauge

Precise reading of the testing pressure

Connection for large bottles

Any size of bottle can be connected without a problem

13

5/16" SAE adaptor for connecting to R410 units



Bottle adaptor for connecting 950 cm<sup>3</sup> bottles



Set (No. 100003865) includes: pressure reducing valve, connection hose, bottle adaptor, pressure gauge, nitrogen bottle and plastic case

Model	Weight	PU	No.
Nitrogen set incl. 1 kg bottle	4.070 kg	1	100003865
Nitrogen bottle à 1,900 cm <sup>3</sup>	2.900 kg	1	259018
Nitrogen bottle à 950 cm <sup>3</sup>	1.235 kg	6	259008

## ROLEAK PRO

Electronic leak detection device for locating leaks in refrigeration systems (3 g/a)

### Application Benefits

- Durable and highly sensitive sensor tip with a leak detection rate of 3 g/a within 3 seconds
- Suitable for R32
- Simple determination of the refrigerant concentration
- Adjustment of the sensor tips zero measurement point for simple detection of the leak
- Reference leak for functionality test included
- Easy accessibility of even hard to reach leaks

R410A

R22

R134a

R407C

R404A

R507A

R32



### Technical Data

Leak status	LED display
Sensor length	40 cm
Leak detection rate	3 g/a within 3 seconds
Working temperature	0 °C up to 40 °C
Voltage	6 V (4 AA batteries included)

#### Audio signal

Comfortable use

#### 7 LEDs

Simple determination of the refrigerant concentrate with the coloured shading

#### RESET-button

Adjusts to the sensor tip zero point setting for simple leak location

#### 3 different sensitivity levels

Exact and fast location of the leak

#### 40 cm long, flexible sensor

Easy access in hard-to-reach places



No. 1500002241

Model	Weight	PU	No.
ROLEAK PRO	1.085 kg	1	1500002241

Evacuation

**ROAIRVAC CL**

**Battery driven two-stage vacuum pump**



**Application Benefits**

- Compatible with CAS or AMPShare battery system
- Solenoid check valve to protect the refrigeration system from oil contamination during power outage
- Protects the integrated components with the light and high-quality casing
- Gas ballast valve for reduction of water vapor in the oil container
- Special filter reduces oil mist on exhaust vent
- Gauge-glass enables easy oil-stand monitoring
- Fast filling of oil without spilling, no special funnel is necessary
- Easy access to the oil drain plug makes emptying quick
- Thermal switch protects the unit from the motor overheating
- Standard 1/4" SAE connection as well as 5/16" SAE and 3/8" SAE adaptor included in delivery

**Technical Data**

	<b>R32 2.0 CL</b>	<b>R32 5.0 CL</b>
Pump rating	2.0 CFM / 57 l/min	5.0 CFM / 142 l/min
Vacuum stages	2	2
Final vacuum	23 micron	15 micron
Motor power	185 W / 3,600 r/m	550 W / 1,800 r/m
Voltage	18 V	18 V
Connection	1/4"	1/4"
with Adapter	5/16" SAEM / 3/8" SAEM	5/16" SAEM / 3/8" SAEM
Oil capacity	180 ml	350 ml



**Gas ballast valve**

Reduction of water vapour in the oil container, guarantees higher evacuation power and service life

**Special filter**

Reduces oil mist on exhaust vent

**Light and high-quality casing**

Protects the integrated components

**Ergonomic handle**

Light, compact and easy to transport

**Battery LED indicator**

Easy management of remaining battery power

**Multiple battery systems**

Suitable for AMPShare or CAS battery systems

**Brushless motor**

For wear-free working and a longer life time

**Available in the manufacturer-independent battery systems AMPShare - Powered by Bosch or CAS - CORDLESS ALLIANCE SYSTEM**

13



<b>Model</b>	<b>Weight</b>	<b>PU</b>	<b>AMPShare-No.</b>	<b>CAS-No.</b>
ROAIRVAC R32 2.0 CL, 1 x 8 Ah battery, charger, ROBUCKET	6.100 kg	1	1000004181	1000003230
ROAIRVAC R32 2.0 CL, without battery and charger	3.700 kg	1	1000004180	1000003229
ROAIRVAC R32 5.0 CL, 1 x 8 Ah battery, charger, ROBUCKET	10.000 kg	1	1000004183	1000003233
ROAIRVAC R32 5.0 CL, without battery and charger	7.500 kg	1	1000004182	1000003231

## ROAIRVAC

**Two-stage vacuum pump For evacuation in accordance with DIN 8975 with vacuum gauge and solenoid valve**



The ROTHENBERGER ROAIRVAC vacuum pumps are used for evacuating all refrigeration circuits according to DIN 8975. The two-stage rotary vane pump achieves a vacuum of less than 25 micron. As a result, air conditioning systems, refrigeration systems and heat pumps can be freed of residual moisture.

### Application Benefits

- Solenoid check valve to protect the refrigeration system from oil contamination during power outage
- Vacuum gauge with integrated drag indicator enables simple and quick control of the evacuation process
- Protects the integrated components with the light and high-quality casing
- Gas ballast valve for reduction of water vapour in the oil container
- Special filter reduces oil mist on exhaust vent
- Gauge-glass enables easy oil-stand monitoring
- Fast filling of oil without spilling, no special funnel is necessary
- Easy access to the oil drain plug makes emptying quick
- Thermal switch protects the unit from the motor overheating
- Standard 1/4" SAE connection as well as 5/16" SAE and 3/8" SAE adaptor included in delivery
- Removable cable prevents cable damage

#### Gas ballast valve

Reduction of water vapour in the oil container, guarantees higher evacuation power and service life

#### Special filter

Reduces oil mist on exhaust vent

#### Light and high-quality casing

Protects the integrated components

#### Ergonomic handle

Light, compact and easy to transport

#### Removable cable

Prevents cable damage

#### Integrated vacuum gauge

Simple and fast control of the evacuation process

#### Integrated solenoid valve

Prevents backwash of oil into the refrigeration system

#### Four-pole motor

Increased torque and long service life (only with ROAIRVAC R32 1.5, 3.0 and 6.0)

1/4" SAE standard connection with adaptors for 5/16" SAE and 3/8" SAE



Optimal positioned viewing glass and oil drains for simple draining of the oil



Practical: operating instructions always within view



Evacuation

**ROAIRVAC series**

Typ	ROAIRVAC R32 1.5	ROAIRVAC R32 3.0	ROAIRVAC R32 6.0	ROAIRVAC R32 9.0
No.	1000002399	1000002713	1000001231	1000002714
Pumprating	1.5 CFM / 42 l / min / 2.5 m³/h	3.0 CFM / 85 l / min / 5.1 m³/h	6.0 CFM / 170 l / min / 10.2 m³/h	9.0 CFM / 255 l / min / 15.3 m³/h
Vacuum stages	2	2	2	2
Final vacuum	15 micron / 0.02 mbar	15 micron / 0.02 mbar	15 micron / 0.02 mbar	15 micron / 0.02 mbar
Motor rating	190 W / 1,720 r/m	250 W / 1,720 r/m	550 W / 1,720 r/m	750 W / 3,440 r/m
Voltage	230 V	230 V	230 V	230 V
Frequency	50 Hz / 60 Hz	50 Hz / 60 Hz	50 Hz / 60 Hz	50 Hz / 60 Hz
Connection	1/4"	1/4"	1/4"	1/4"
with adaptor	5/16" SAE M / 3/8" SAE M	5/16" SAE M / 3/8" SAE M	5/16" SAE M / 3/8" SAE M	5/16" SAE M / 3/8" SAE M
Oil capacity	250 ml	330 ml	580 ml	590 ml
Manifold Ø	45 mm	50 mm	80 mm	80 mm

**Future-proof product for the increased use of R32 refrigerants**



ROAIRVAC R32 1.5 (42 l/min)



ROAIRVAC R32 3.0 (85 l/min)



ROAIRVAC R32 9.0 (255 l/min)

Mineral oil is included in all pump deliveries



ROAIRVAC R32 6.0 (170 l/min)



ROAIRVAC R32 1.5—vacuum pump in use with the digital manifold ROCOOL 600



Scope of delivery: vacuum pump with 1/4", 5/16" SAE and 3/8" SAE connections, plastic bottle with mineral oil

Model	Weight	PU	No.
ROAIRVAC R32, 1.5 42 l/min	10.100 kg	1	1000002399
ROAIRVAC R32, 3.0 85 l/min	11.900 kg	1	1000002713
ROAIRVAC R32, 6.0 170 l/min	17.500 kg	1	1000001231
ROAIRVAC R32, 9.0 255 l/min	18.400 kg	1	1000002714
Mineral oil, 1 litre	0.945 kg	1	169200

**ROREC**

**Refrigerant recovery device**

Compact, portable device for recovery and recycling refrigerants of all kinds



**Application Benefits**

- Maintenance-free operation through oil-free compressor
- 4-pole motor guarantees durability of the machine
- Low noise and vibration emissions because of its compact design
- Simple and safe work through intuitive operation
- Emptying of refrigerant residue by using the PURGE function for working with different refrigerants

**Technical Data**

Suitable for	all A1 refrigerants of the type CFC, HCFH and HFC
Capacity	gaseous: 0.26 kg/min fluid: 1.85 kg/min push/pull: 6.22 kg/min
Electrical data	230 V / 50-60 Hz
Power	370 W
High pressure switch	38.5 bar

**Ideal for mono and multi-split air-conditioning units and heat pumps!**

**Integrated high pressure switch**

Protects the integrated components

**PURGE function**

Emptying of refrigerant residue in the unit (self-cleaning mode)

**Simple use**

Controlled dosage of the refrigerant supply

**RESET Button**

Reset of the pressure shut-off

**Removable cable**

Prevents cable damage

**Oil-free compressor**

Maintenance-free operation

**Thermal switch**

Protects the unit from overheating

**Light and compact plastic casing**

Simple transport and use

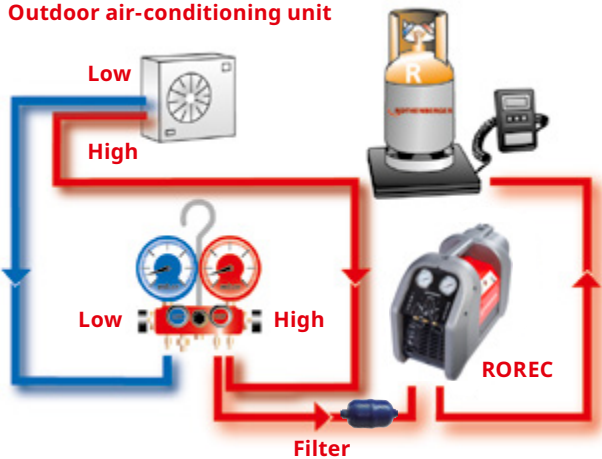
**4-pole motor**

Increased torque and service life



**Recovery of refrigerant**

**Exemplary: Outdoor air-conditioning unit**



Simple and precise reading with the glycol filled pressure gauge

Practical storage compartment for accessories on the back



Model	Weight	PU	No.
ROREC	17.000 kg	1	168605
Filter	0.120 kg	1	168713

RO SERVICE+ only valid in participating countries.

**ROREC PRO A3**

**Refrigerant extractor**

Refrigerant extraction unit with high extraction capacity for complete emptying of refrigeration and air conditioning systems



**Application Benefits**

- Explosion-proof: Suitable for refrigerants of classes A1, A2L, A2 and A3 (e. g. R290)
- Compact design and weight of less than 12 kg
- Digital display and one-button operation
- Maintenance-free operation due to oil-free 2-piston compressor
- 4-pole motor guarantees longevity of the machine
- Automatic shutdown and automatic start as soon as the pressure rises again
- Draining of refrigerant residues through PURGE function

**Technical Data**

Recovery rate	gaseous: 0.5 kg/min; 3 kg/h fluid: 3.5 kg/min; 21 kg/h push/pull: 9.5 kg/min; 57 kg/h
Working area pressure	38.5 bar
Input power	750 W
Frequency	50–60 Hz
Voltage	220–240 V

**Digital display**

Clearly structured display of the measured pressure values

**Low pressure switch**

Automatic shut-off and automatic restart once the pressure increases again

**Oil-free 2-piston compressor**

Very high recovery rate with maintenance free operation



Model	Weight	PU	No.
ROREC Pro A3	12.000 kg	1	1500004451
Filter	0.120 kg	1	168713



## ROSCALE 120

### Electronic refrigerant scale

Precise, easy to handle refrigerant scale for filling and evacuation processes with a maximal weight capacity of 120 kg

#### Application Benefits

- Resolution of 5 g enables very precise filling
- Weight capacity sufficient for all common refrigerant bottles
- Cable connection enables comfortable use in every situation
- Bottle adaptor for connecting small refrigerant bottles (1 l and 2 l bottles)
- Refrigerant bottles of all sizes have enough space
- Large LCD display for comfortable reading of the result
- Simple use

#### Technical Data

Weight capacity	120 kg or 264 lbs
Accuracy	± 0.5 %
Resolution	5 g / 0.2 oz.
Working temperature	-10 °C up to 49 °C / 14 °F up to 120 °F
Connection	1/4" SAE for 1-2 l bottles
Battery	9V
Platform size	230 × 230 × 53 mm



ROSCALE 120 in carrying case

Set (No. R17300416) includes: ROSCALE 120, 9V battery, carrying case

Model	Weight	PU	No.
ROSCALE 120 up to 120 kg	3.280 kg	1	R17300416

## Refrigerant for air-conditioning units

**Non-chlorinated refrigerant of the HFC group in practical 40 bar steel bottles (bursting pressure: 165 bar) TÜV seal No. 0036-043 / 03D and TPED accepted as per 9 / 36 / CE**

With ROTHENBERGER refrigerant, installers and refrigeration technicians can fill air conditioning and refrigeration systems that are particularly difficult to access. Due to the compact bottle, transport to roofs etc. is also easy.

**Standardised SAE thread on all bottle valves**

Universal application

**Refillable bottles**

Full flexibility for the user



Model	Weight	PU	No.
<b>R410A</b> Refrigerant R410A in cardboard packaging			
1 l steel bottle 5/16" SAE, 40 bar	1.545 kg	6	170912
2 l steel bottle 5/16" SAE, 40 bar	3.145 kg	4	170932
<b>R32</b> Refrigerant R32 in cardboard packaging			
1 l steel bottle 1/2" SAE, 40 bar	1.535 kg	6	170960
2 l steel bottle 1/2" SAE, 40 bar	3.320 kg	4	170961



## SANIFRESH

### Deodorising cleaning spray

#### Application Benefits

- Removes the threat of disease and allergies—practical and ecologically friendly solution for removing mites, dust, bacteria and spores
- Spray is applied directly to affected surface
- Economical spray can with spray nozzle and spray tube
- Removes unpleasant odours. Pleasant mint smell



Model	Weight	PU	No.
SANIFRESH 12 bottles	3.960 kg	1	85800

## Bottle connection and adaptors

### For refrigerant bottles

For use with new refrigerant bottles on existing equipment



No. 170950, No. 1500003381

No. 173204, No. 173205

No. 01700RD

Model	No.
Adapter 1/2" to 1/4" SAE	170901
Adaptor 1/4" SAE M, 5/16" SAE F, with valve trigger	01700RD
Adapter 1/4" SAE F to 5/16" SAE, M connection	170016
Adapter 1/4" SAE M, 3/8" SAE F	89501
Adapter 3/8" SAE M, 1/4" SAE F	89503
Bottle adapter 1/4" connection	173205
Bottle adapter 5/16" connection	173204
Bottle adapter W21.8 x 1/4" SAE, M connection, seal for 2l sized bottles	170950
Bottle adapter W21, 8 x 1/4" SAE, M connection (left)	1500003381

## Torque wrench set

### For proper tightening of flange connections

Set with adjustable torque wrench (10–70 Nm) and 6 spanner inserts sizes 17, 22, 24, 26, 27 and 29 mm for flange connections on 1/4", 3/8", 1/2" and 5/8" pipe lines according to DIN EN 378- 2:2012-08



**Fix with torque wrench urgently necessary!**



7-piece set (No. 175001) includes: spanner wrench sizes 17, 22, 24, 26, 27, 29 mm, torque wrench, carrying bag

Ø	Spanner width	Locking torque
1/4" / 6 mm	17 mm	14–18 Nm
3/8" / 10 mm	22 mm	33–42 Nm
1/2" / 12 mm	24 mm	50–62 Nm
1/2" / 12 mm	26 mm	50–62 Nm
5/8" / 15/16 mm	27 mm	63–77 Nm
5/8" / 15/16 mm	29 mm	63–77 Nm

Model	Weight	PU	No.
Torque wrench set 17–22–24–26–27–29 mm	1.700 kg	1	175001

## Schrader valve tool

### Application Benefits

- For exchanging the Schrader valve on air-conditioners under pressure, without having to recover the unit
- For safe and easy change of spring insert of the Schrader valve tool
- With safety thread for risk-free use with R410A



Model	Weight	PU	No.
Schrader valve tool	0.450 kg	1	87800

## Plate fin comb

### Application Benefits

- For straightening the plate fins of heat-exchangers
- 6 different sizes in one too

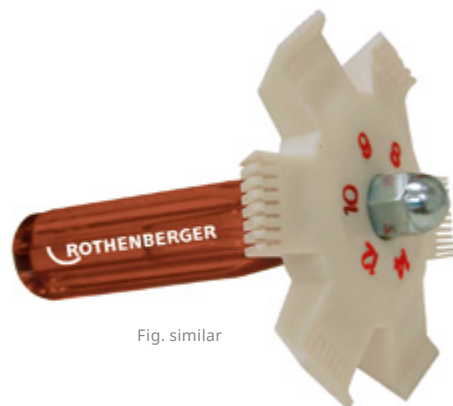


Fig. similar

Model	Weight	PU	No.
Plate fin comb 8-9-10-12-14-15 fins per inch	0.095 kg	1	224500

## Refrigerant data from CFC-alternative refrigerants

Refrigerant	Composition	ODP	GWP	Temperature glide
R22 (HFCKW refrigerant)	CHCLF2	0.05	1,810	
R134a (HFKW-chlorine-free refrigerant)	CF3CH2F	0	1,430	
R32 (HFKW-chlorine-free refrigerant)	CH2F2	0	675	
R404A (HFKW-chlorine-free blends)	52 % R143a, 44 % R125, 4 % R134a	0	3,922	
R507 (HFKW-chlorine-free blends)	50 % R143a, 50 % R125	0	3,985	
R407C (HFKW-chlorine-free blends)	23 % R32, 25 % R125, 52 % R134a	0	1,774	7.5 K
R410A (HFKW-chlorine-free blends)	50 % R32, 50 % R125	0	2,088	0.2 K

ODP = Ozone Depletion Potential (degree in which the ozone layer is destroyed)

GWP = Global Warming Potential (degree in which it contributes to the greenhouse effect)

## Instructions for safe and proper use of the refrigerants

### Refrigerant

- Wear protective gloves and safety goggles
- Do not let refrigerant come in contact with skin
- Do not inhale high concentrations of vapours (Lack of oxygen causes a narcotic effect and is a danger to life)
- Do not smoke around refrigerant
- Working place / room must be thoroughly aired, if necessary extracted

### Refrigerant bottles

- Secure against accidents, do not throw
- Do not expose to direct sunlight and do not place near radiators or other heat sources
- Do not use open flame
- Do not disassemble or remove valves
- Damaged bottles need to be properly returned
- Close empty containers

### Air-conditioners

- Air-conditioner leaks need to be repaired immediately
- Do not allow refrigerant to leak while filling or doing maintenance work
- In high concentrations (for example pipe burst), leave the room and do not enter again until it has been properly ventilated
- Only do brazing work together with protective nitrogen gas and only in well ventilated areas

## Flare connections

Normal flare size in accordance with JIS B8607:2008

Flare outer diameter in relationship to the pipe diameter

Pipe outer diameter mm / inch	Metric	Wall thickness mm / inch	Flare outer diameter with R22-, R134a-, R404-, R407C air-conditioners	Flare outer diameter with R410A air-conditioners
6 mm		1 mm	8.5 mm	9.1 mm
8 mm		1 mm	11.1 mm	11.1 mm
10 mm		1 mm	13.6 mm	13.2 mm
12 mm		1 mm	15.3 mm	16.5 mm
16 mm		1 mm	19.5 mm	19.2 mm
18 mm		1 mm	22.0 mm	22.7 mm
1/4"	6.35 mm	0.35"	9.0 mm	9.1 mm
5/16"	7.94 mm	0.35"	11.0 mm	11.1 mm
3/8"	9.52 mm	0.35"	13.0 mm	13.2 mm
1/2"	12.70 mm	0.35"	16.2 mm	16.6 mm
5/8"	15.88 mm	0.35"	19.4 mm	19.7 mm
3/4"	19.05 mm	0.35"	23.3 mm	24.0 mm

## Conversion table pressure

mbar	Micron	TORR	mm HG Vakuum
10	7,516	7.5	752
5	3,759	3.6	756
2	1,503	1.5	758
1	752	0.75	759
0.5	376	0.36	
0.4	300	0.30	
0.3	225	0.23	
0.2	150	0.15	
0.1	75	0.08	
0.09	68		
0.07	53		
0.06	45		
0.05	38		
0.04	30		
0.03	22		
0.02	15		
0.01	8		

## Conversion table temperature

Conversion from °C in °F:  $^{\circ}\text{C} \times 1.8 + 32 = ^{\circ}\text{F}$

Conversion from °F in °C:  $(^{\circ}\text{F} - 32) : 1.8 = ^{\circ}\text{C}$

°C	°F	°C	°F	°F	°C	°F	°C
100	212	30	86	212	100	70	21
95	203	25	77	200	93	60	16
90	194	20	68	190	88	50	10
85	185	15	59	180	82	40	4
80	176	10	50	170	77	30	-1
75	167	4	39	160	71	20	-7
70	158	0	32	150	66	10	-12
65	149	-10	14	140	60	0	-18
60	140	-20	-4	130	54	-10	-23
55	131	-30	-22	120	49	-20	-29
50	122	-40	-40	110	43	-30	-34
45	113	-50	-58	100	38	-40	-40
40	104	-60	-76	90	32	-50	-46
35	95	-273	-460	80	27	-60	-51
						-112	-80
						-460	-273

## Common threads

UNF-Thread	SAE-Thread	Outer diameter (max. mm)	Internal diameter (min. mm)	Lodes per inch	Increment (mm)
7/16"-20	1/4"	11.079	9.738	20	1.270
1/2"-20	5/16	12.667	11.328	20	1.270
5/8"-18	3/8"	15.839	14.348	18	1.411
3/4"-16	1/2"	19.012	17.330	16	1.588
7/8"-14		22.184	20.262	14	1.814
7/8"-14	5/8"	22.184	20.262	14	1.814
1"-14	3/4"	25.357	23.437	14	1.814
1 1/16"-14		26.947	25.024	14	1.814
1 1/8"-12		28.529	26.284	12	2.117
1 1/4"-12	7/8"	31.704	29.459	12	2.117
1 3/8"-12		34.877	32.634	12	2.117
1 1/2"-12	1"	38.052	35.809	12	2.117



1) Detailed guarantee terms at:  
<https://rothenberger.com/gb-en/service/repairs-servicing-and-spare-parts>  
(Only in participating countries)





## Universal tools



<b>System overview</b>	<b>328-331</b>
<b>Pliers</b>	
Water pump pliers	332-335
Pliers sets	336
Corner pipe wrenches	337
One-handed pipe wrenches, chain pipe wrenches	338-340
Grip pliers, strap and fittings wrenches	340-342
<b>Installation wrenches</b>	
UNI stepped key set	343
Sanitary four way	343
Valve key	344
Open-ended, hinged ratchet wrenches	344-346
<b>Screwdrivers</b>	
Screwdriver sets	347-348
<b>Installation aids</b>	
Spirit levels, cartridge extractor sets	349
Tap reseating tool	350
Combination and electrical pliers	351
<b>Drilling and screwing</b>	
Drill driver and drill bits	352-355, 358
Cordless impact wrench	355
<b>Cutting and grinding</b>	
Cordless angle grinder	356
Cutting and grinding discs	357
<b>General aids</b>	
Cordless LED lamp	359
Battery packs and charger	361-360
Hammers, chisels	362
Vices	363
Workbenches	364
General aids and tool bags	365-367
Case system	368-371

**ROGRIP pliers**

ROGRIP M 7" 1K ROGRIP M 7" 2K ROGRIP M 10" 1K ROGRIP M 10" 2K ROGRIP F 7" 1K ROGRIP F 7" 2K



Working range	Ø 43 mm (1.1/4")	Ø 43 mm (1.1/4")	Ø 60 mm (2")	Ø 60 mm (2")	Ø 43 mm (1.1/4")	Ø 43 mm (1.1/4")
Length	185 mm (7")	185 mm (7")	254 mm (10")	254 mm (10")	185 mm (7")	185 mm (7")
Weight	0.245 kg	0.255 kg	0.490 kg	0.490 kg	0.215 kg	0.227 kg
Material	Chrome vanadium steel					
Page	332	332	332	332	332	332

**ROGRIP pliers** | **Water pump pliers**

ROGRIP F 10" 1K ROGRIP F 10" 2K ROGRIP XL SP 7" SP 10" SP 12"



Working range	Ø 60 mm (2")	Ø 60 mm (2")	Ø 102 mm (3.1/2")	Ø 34 mm (1")	Ø 43 mm (1.1/4")	Ø 48 mm (1.1/2")
Length	254 mm (10")	254 mm (10")	440 mm (16")	175 mm (7")	250 mm (10")	300 mm (12")
Weight	0.470 kg	0.480 kg	1.400 kg	0.150 kg	0.290 kg	0.460 kg
Material	Chrome vanadium steel			Chrome vanadium steel		
Page	332	332	333	334	334	334

**Water pump pliers** | **Corner pipe wrenches 45°**






SPK 7" SPK 10" SPK 12" „Super S" 10" „Super S" 12"



Working range	Ø 34 mm (1")	Ø 43 mm (1.1/4")	Ø 48 mm (1.1/2")	Ø 22 mm (1/2")	Ø 34 mm (1")
Length	175 mm (7")	250 mm (10")	300 mm (12")	250 mm (10")	300 mm (12")
Weight	0.165 kg	0.315 kg	0.475 kg	0.400 kg	0.810 kg
Material	Chrome vanadium steel			Chrome vanadium steel	
Page	335	335	335	337	337








**Corner pipe wrenches 45°**

	„Super S“ 16"	„Super S“ 20"	„Super S“ 24"	10"	12"
					
Working range	Ø 48 mm (1.1/2")	Ø 60 mm (2")	Ø 89 mm (3")	Ø 22 mm (1/2")	Ø 34 mm (1")
Length	420 mm (16")	540 mm (20")	640 mm (24")	250 mm (10")	300 mm (12")
Weight	1.440 kg	2.440 kg	3.400 kg	0.370 kg	0.740 kg
Material	Chrome vanadium steel	Chrome vanadium steel	Chrome vanadium steel	Chrome vanadium steel	Chrome vanadium steel
Page	337	337	337	337	337

**Corner pipe wrenches 45°**

**Pipe wrenches 90°**

	16"	20"	12"	16"	20"
					
Working range	Ø 48 mm (1.1/2")	Ø 60 mm (2")	Ø 34 mm (1")	Ø 48 mm (1.1/2")	Ø 60 mm (2")
Length	420 mm (16")	540 mm (20")	300 mm (12")	420 mm (16")	540 mm (20")
Weight	1.340 kg	2.400 kg	0.740 kg	1.340 kg	2.400 kg
Material	Chrome vanadium steel	Chrome vanadium steel	Chrome vanadium steel	Chrome vanadium steel	Chrome vanadium steel
Page	337	337	337	337	337

**Pipe wrenches 90°**

**One-handed pipe wrench HEAVY DUTY**

	24"	36"	HEAVY DUTY 6"	HEAVY DUTY 8"	HEAVY DUTY 10"
					
Working range	Ø 89 mm (3")	Ø 114 mm (4")	Ø 22 mm (1/2")	Ø 34 mm (1")	Ø 48 mm (1.1/2")
Length	640 mm (24")	750 mm (36")	152 mm (6")	200 mm (8")	250 mm (10")
Weight	3.400 kg	5.600 kg	0.250 kg	0.400 kg	0.780 kg
Material	Chrome vanadium steel	Chrome vanadium steel	Chrome vanadium steel	Chrome vanadium steel	Chrome vanadium steel
Page	337	337	338	338	338

**One-handed pipe wrench HEAVY DUTY**

**HEAVY DUTY 12"**



**HEAVY DUTY 14"**



**HEAVY DUTY 18"**



**HEAVY DUTY 24"**



**HEAVY DUTY 36"**



Working range	Ø 60 mm (2")	Ø 60 mm (2")	Ø 73 mm (2.1/2")	Ø 80 mm (3")	Ø 141 mm (5")
Length	300 mm (12")	350 mm (14")	450 mm (18")	600 mm (24")	900 mm (36")
Weight	1.250 kg	1.680 kg	2.670 kg	4.320 kg	7.500 kg
Material	Chrome vanadium steel	Chrome vanadium steel	Chrome vanadium steel	Chrome vanadium steel	Chrome vanadium steel
<b>Page</b>	<b>338</b>	<b>338</b>	<b>338</b>	<b>338</b>	<b>338</b>

**One-handed pipe wrench HEAVY DUTY**

**HEAVY DUTY 48"**



**HEAVY DUTY 60"**



**One-handed pipe wrench ALUDUR**

**ALUDUR 10"**



**ALUDUR 14"**



**ALUDUR 18"**



Working range	Ø 168 mm (6")	Ø 203 mm (8")	Ø 48 mm (1.1/2")	Ø 60 mm (2")	Ø 73 mm (2.1/2")
Length	1,200 mm (48")	1,500 mm (60")	250 mm (10")	350 mm (14")	450 mm (18")
Weight	15.800 kg	24.000 kg	0.480 kg	0.990 kg	1.630 kg
Material	Chrome vanadium steel	Chrome vanadium steel	Aluminium	Aluminium	Aluminium
<b>Page</b>	<b>338</b>	<b>338</b>	<b>338</b>	<b>338</b>	<b>338</b>

**One-handed pipe wrench ALUDUR**

**ALUDUR 24"**



**ALUDUR 36"**



**ALUDUR 48"**



**ALUDUR 60"**



**Pliers wrench**

**ROFAST 10"**



Working range	Ø 89 mm (3")	Ø 141 mm (5")	Ø 168 mm (6")	Ø 200 mm (8")	Ø 52 mm (1.7/8")
Length	600 mm (24")	900 mm (36")	1,200 mm (48")	1,500 mm (60")	254 mm (10")
Weight	2.510 kg	5.000 kg	8.420 kg	14.600 kg	0.530 kg
Material	Aluminium	Aluminium	Aluminium	Aluminium	Chrome vanadium steel
<b>Page</b>	<b>338</b>	<b>338</b>	<b>338</b>	<b>338</b>	<b>341</b>

**One-handed pipe wrench STILLSON**

**STILLSON 8"**

**STILLSON 10"**

**STILLSON 12"**

**STILLSON 14"**

**STILLSON 18"**



Working range	Ø 27 mm (3/4")	Ø 34 mm (1")	Ø 43 mm (1.1/4")	Ø 48 mm (1.1/2")	Ø 60 mm (2")
Length	200 mm (8")	250 mm (10")	300 mm (18")	350 mm (14")	450 mm (18")
Weight	0.280 kg	0.590 kg	0.715 kg	1.040 kg	1.740 kg
Material	Steel, drop forget	Steel, drop forget	Steel, drop forget	Steel, drop forget	Steel, drop forget
<b>Page</b>	<b>338</b>	<b>338</b>	<b>338</b>	<b>338</b>	<b>338</b>

**One-handed pipe wrench STILLSON**

**ROCASE case system**

**STILLSON 24"**

**STILLSON 36"**

**ROCASE**

**ROBOX**



Working range	Ø 73 mm (2.1/2")	Ø 102 mm (3.1/2")	Sizes	5	2
Length	600 mm (24")	900 mm (36")	Volume	5.7-48.2l	0.65-1.37l
Weight	3.080 kg	5.690 kg	Weight	0.630-2.640 kg	0.090-0.170 kg
Material	Steel, drop forget	Steel, drop forget	Material	ABS plastic	ABS plastic
<b>Page</b>	<b>338</b>	<b>338</b>	<b>Page</b>	<b>368</b>	<b>369</b>

**Power Tools**

**RO DD 60**

**RO ID 400**

**RO AG 8000**

**RO FL 180**



System battery	CAS	CAS	CAS	CAS
Type battery	Li-Power	Li-Power	Li-HD	Li-HD
Idle speed	0-450/min	0-2,150/min	8,000/min	○
Weight with battery	1.770 kg	1.900 kg	2.400 kg	1.570 kg
<b>Page</b>	<b>352</b>	<b>355</b>	<b>355</b>	<b>359</b>

## Universal tools

### Water pump pliers

#### ROGRIP M

##### Quick adjustable water pump pliers

Holds and grips a wide variety of pipe types up to Ø2"

##### Application Benefits

- Durable: Due to the double hardening, the teeth are particularly wear-resistant
- Slip resistant: The shape of the teeth ( self locking), the 3-touch-point grip on the pipe and the soft-touch handle, prevent slipping off the pliers.
- Large gripping capacity: 30 % more gripping capacity<sup>1)</sup>: 10" pliers up to 2" pipe diameter.

##### Technical Data

Working area diameter	2"
Working area diameter	0–60 mm
Material	Chrome vanadium steel

Model	Weight	PU	No.
ROGRIP M, 7", 1K	0.235 kg	6	1000002697
ROGRIP M, 7", 2K	0.250 kg	6	1000002698
ROGRIP M, 10", 1K	0.470 kg	6	1000002699
ROGRIP M, 10", 2K	0.495 kg	6	1000002700

#### ROGRIP F

##### Quick adjustable water pump pliers

Holds and grips a wide variety of pipe types up to Ø2"

##### Application Benefits

- Durable: Due to the double-hardened teeth, the teeth only wear slowly
- Slip-resistant: The shape of the teeth (self-locking), the 3-touch-point grip on the pipe and the soft-touch handle, prevent slipping off the pliers
- Large gripping capacity: 30 % more gripping capacity: 10" pliers up to 2" pipe diameter
- Safety lock system: prevents unintentional opening and enables a 50 % quicker adjustment

Curve-Shape-Design: especially ergonomic

3-point grip over the middle for reliable clam-ping. Perfect grip on pipes up to Ø2"



Model	Weight	PU	No.
ROGRIP F, 10", 1K	0.405 kg	6	1000002704
ROGRIP F, 10", 2K	0.425 kg	6	1000002705
ROGRIP F, 7", 1K	0.215 kg	6	1000002701
ROGRIP F, 7", 2K	0.225 kg	6	1000002702

##### Double hardened jaws, extremely durable

Firm grip on any surface even under the strongest conditions

##### ROTHENBERGER Curve-Shape-Design

Particularly ergonomic for large pipe diameters. Reduces the risk of pinching fingers

##### Large grip width

Reliable grip and hold up to 2" pipe diameter

##### New handle design

Good grip with two handle versions

##### Wide handles

More comfort and better power transmission



**ROTHENBERGER Curve-Shape-Design—7" pliers has the same gripping capacity as a normal 10" WAPU**

##### Double hardened jaws, extremely durable

Firm grip on any surface even under the strongest conditions

##### ROTHENBERGER Curve-Shape-Design

Particularly ergonomic for large pipe diameters. Reduces the risk of pinching fingers

##### Large grip width

Reliable grip and hold up to 2" pipe diameter

##### New handle design

Good grip with two handle versions

##### Wide handles

More comfort and better power transmission



##### Safety blocking system

Prevents unintentional opening and enables up to 50 % faster adjustment

**ROTHENBERGER Curve-Shape-Design—7" pliers has the same gripping capacity as a normal 10" WAPU**

## ROGRIP XL

### Quick adjustable water pump pliers

#### Application Benefits

- 16" pliers up to 3.1/2" pipe diameters
- 3-point grip: reliable clamping and perfect grip up to the maximum pipe diameter.
- ROTHENBERGER Curve-Shape-Design: especially ergonomic by large pipe diameters. Reduces the danger of fingers getting clamp
- Wide handles for more comfort and better power transmission
- 14 adjustment positions for variable working

#### Technical Data

Working area diameter	3.1/2"
Working area diameter	102 mm
Material	Chrome vanadium steel

**Enourmous gripping width of 3.1/2" — reliable grip during application**



**Double hardened jaws, extremely durable**

Firm grip on any surface even under the strongest conditions



**Large grip width**

Secure gripping and holding up to 3.1/2" pipe diameter

#### 14 adjustment positions

Variable working, laterally stable and high load capacity

#### ROTHENBERGER Curve-Shape-Design

Particularly ergonomic for large pipe diameters. Reduces the risk of pinching fingers

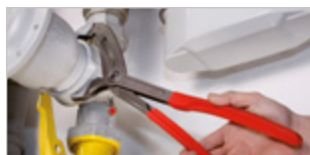
**Slip-resistant plastic handles**

High grip reliability

**Wide handles**

More comfort and better power transmission

Curve-Shape-Design: especially ergonomic



3-point grip over the middle for reliable clamping. Perfect grip on pipes up to Ø3.1/2"



**ROTHENBERGER Curve-Shape-Design — especially ergonomic!**

Model	Weight	PU	No.
ROGRIP XL, 102 mm (3.1/2")	1.400 kg	1	100000328

### Water pump pliers SP

According to DIN 5231 D, with heavy-duty box joint, chrome vanadium steel, drop-forged, tempered, polish head and joint



#### Application Benefits

- Ideal for hard-to-reach places with the longer, thinner pliers head with measurements favourable for corners
- Optimum grip for reliable hold of pipes, flat objects, squared and hexagonal screw
- Long service life due to induction-hardened teeth
- Variable use: 7 size settings
- Non-slip even on smooth pipes
- Safest use with the crush and pinch protection

#### Technical Data

Working area diameter	0-1.1/2"
Working area diameter	0-48 mm
Material	Chrome vanadium steel



Model	Weight	PU	No.
Water pump plier SP, 34 mm (1")	0.150 kg	6	70527
Water pump plier SP, 43 mm (1.1/4")	0.290 kg	6	70528
Water pump plier SP, 48 mm (1.1/2")	0.460 kg	6	70529
Water pump pliers set SP, 7-10-12"	0.940 kg	1	70520

## Water pump pliers SPK



### Application Benefits

- Self-clamping jaws: Non-slip even on smooth pipes
- Long, slim pliers head: Ideal for hard-to-reach places
- Induction hardened teeth: For a long service life
- 7-way adjustable: Allows variable work
- Anti-slip plastic handles: High grip safety even when working with water and oil

### Technical Data

Working area diameter	1.1/2"
Working area diameter	0-48 mm
Material	Chrome vanadium steel
Material handle	Dipped handles

**Increased safety:  
Plastic covered handles!**



Model	Weight	PU	No.
Water pump plier SPK, 34 mm (1")	0.165 kg	6	70521
Water pump plier SPK, 43 mm (1.1/4")	0.315 kg	6	70522
Water pump plier SPK, 12 pieces, counter display	4.335 kg	1	070522D
Water pump plier SPK, 48 mm (1.1/2")	0.475 kg	6	70523
Water pump plier SPK, 48 mm (1.1/2"), with hanger	0.530 kg	1	070523E

## Groove water pump pliers CL

**Chrome-vanadium special steel, chrome-plated, drop-forged, hardened and tempered, polished head, with slip-on joint, straight jaws, according to DIN 5231 E**



### Application Benefits

- No slipping of the joint possible
- Absolutely firm fit in every open position
- Easy, smooth adjustment
- Induction-hardened teeth for long service life
- Crush and clamp guard prevent injuries
- Plastic covered handles

### Technical Data

Working area diameter	0-4"
Working area diameter	0-114 mm
Material	Chrome vanadium steel
Material handle	Dipped handles



Model	Weight	PU	No.
Grooved water pump plier CL, 48 mm (1.1/2")	0.330 kg	1	70591
Grooved water pump plier CL, 60 mm (2")	0.560 kg	1	70592
Grooved water pump plier CL, 114 mm (4")	1.150 kg	1	70593

## Universal tools

### Hand tool sets / Water pump pliers

#### ROBOX pliers sets

##### 3 pieces pliers sets for holding and turning of diverse types of pipes

The ROBOX sets contain a selection of hand tools for all aspects of pipe processing. The tools are supplemented by the practical ROBOX. Consumables such as fittings can be stored alongside your tools.



3 pieces set (No. 1000002189) includes:  
one-handed pipe wrench ALUDUR, 14" (No. 70160), ROGRIP M 10", 1K (No. 100002699), ROGRIP M 7", 1K (1000002697), ROBOX B2650 (No. 1000002763)

Model	Weight	PU	No.
ROBOX pliers set 3 pieces, with pipe wrench ALUDUR, ROBOX	1.700 kg	1	1000002189

#### Professional sets

##### Practice-oriented set of pipe wrenches and pipe cutter



3 pieces set (No. 070130X) includes: pipe wrench 1" (No. 070122X), pipe wrench 1.1/2" (No. 070123X), pipe wrench 2" (No. 070124X)

4 pieces set (No. 070135X) includes: pipe wrench 1" (No. 070122X), pipe wrench 1.1/2" (No. 070123X), wapu SP 10" (No. 70528), TUBE CUTTER 35 (No. 70027)

3 pieces set (No. 070140X) includes: pipe wrench 1" (No. 070122X), pipe wrench 1.1/2" (No. 070123X), wapu SP 10" (No. 70528)



No. 070130X



No. 070135X



No. 070140X

Model	Weight	PU	No.
Corner pipe wrench set 1, 3 pieces, 1-2"	5.000 kg	1	070130X
Corner pipe wrench set 2, 4 pieces, TUBE Cutter 35, water pump plier SP, 1", corner pipe wrench 1-1.1/2"	3.100 kg	1	070135X
Corner pipe wrench set 3 Corner pipe wrench 1-1.1/2", water pump plier SP, 1"	2.700 kg	1	070140X
Corner pipe wrench set 1-1.1/4-1.1/2-2"	5.100 kg	1	070137X

#### ROGRIP pliers sets

##### The quickly adjustable water pump pliers generation ROGRIP is available as a practical set with three different sizes

For work in installation and assembly.



No. 1000001068

3 pieces set (No. 1000001068) includes:  
ROGRIP M7", 1K (No. 1000002697),  
ROGRIP M10", 1K (No. 1000002699),  
ROGRIP XL, 16" (No. 1000000328)

Model	Weight	PU	No.
ROGRIP set M, 7", 1K, 10", 1K, ROGRIP XL	2.300 kg	1	1000001068



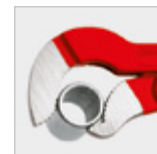
### Corner pipe wrench 45° SUPER S

Chrome vanadium steel, drop forged, tempered, with reinforced sleeve, polished jaws and a favourable size for corners

The corner pipe wrench 45° SUPER S can be used for clamping and rotating pipes with Ø 1/2" to 3"

#### Application Benefits

- Self-clamping: 3-point clamping ensures reliable and firm grip even with smooth pipes
- Reliable grip and non-slip with teeth set against turning direction, induction hardened
- Double T-profile handle, ideal for clamping different materials forms, enables universal application



Model	Weight	PU	No.
22 mm (1/2")	0.400 kg	6	070121X
34 mm (1")	0.810 kg	1	070122X
48 mm (1.1/2")	1.440 kg	1	070123X
60 mm (2")	2.440 kg	1	070124X
89 mm (3")	3.400 kg	1	70125

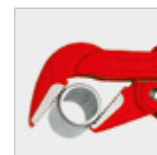
### Corner pipe wrench 45°

Chrome vanadium steel, drop forged, tempered, with reinforced sleeve, polished jaws

Holding and turning of a wide variety of pipe types in the range Ø 1/2" to 2"

#### Application Benefits

- Favourable size for corners
- Thin muzzle with thin jaws, 45° angled



Model	Weight	PU	No.
22 mm (1/2")	0.370 kg	1	070131X
34 mm (1")	0.740 kg	1	070132X
60 mm (2")	2.400 kg	1	070134X

### Pipe wrench 90°

Chrome vanadium steel, drop forged, tempered, with reinforced sleeve, polished jaws.

Holding and turning of a wide variety of pipe types in the range Ø 1" to 4"

#### Application Benefits

- Favourable size for corners
- Thin muzzle with thin jaws, 90° angled



Model	Weight	PU	No.
34 mm (1")	0.740 kg	1	070110X
48 mm (1.1/2")	1.340 kg	1	070111X
60 mm (2")	2.400 kg	1	070112X
89 mm (3")	3.400 kg	1	70113
114 mm (4")	5.600 kg	1	70114

### One-handed pipe wrench HEAVY DUTY

#### Application Benefits

- Self-clamping, hook spring-loaded
- Quick preset of pipe-Ø using scale on hook
- Wearing parts replaceable: hook and heel jaw can be purchased separately
- Monobloc cast iron body with high strength, double T-profile, forged jaw and hooks, fine polished, teeth set against the turning direction, induction hardened, tempered and non-slip adjusting screw



#### US-Norm GGG-W-651 Type II Class A



Model	Size	Weight	PU	No.	Hook	Jaws
160 mm (6")	26 mm (3/4")	0.250 kg	1	70148	70199	70189
200 mm (8")	34 mm (1")	0.400 kg	1	70150	70200	70190
250 mm (10")	48 mm (1.1/2")	0.780 kg	1	70151	70201	70191
300 mm (12")	60 mm (2")	1.250 kg	1	70152	70202	70192
350 mm (14")	60 mm (2")	1.680 kg	1	70153	70203	70193
450 mm (18")	73 mm (2.1/2")	2.670 kg	1	70154	70204	70194
600 mm (24")	89 mm (3")	4.320 kg	1	70155	70205	70195
900 mm (36")	141 mm (5")	7.500 kg	1	70156	70206	70196
1,200 mm (48")	168 mm (6")	15.800 kg	1	70157	70207	70197
1,500 mm (60")	203 mm (8")	24.000 kg	1	70158	70208	70198

### One-handed pipe wrench ALUDUR

#### Application Benefits

- Features similar HEAVY DUTY
- Weight saving of approx. 40%: extremely light, high strength aluminium alloy
- Wearing parts replaceable, hook and heel jaw can be purchased separately



#### US-Norm GGG-W-651 Type I Class B



Model	Size	Weight	PU	No.	Hook	Jaws
250 mm (10")	48 mm (1.1/2")	0.480 kg	1	70159	70201	70191
350 mm (14")	60 mm (2")	0.990 kg	1	70160	70203	70192
450 mm (18")	73 mm (2.1/2")	1.630 kg	1	70161	70204	70194
600 mm (24")	89 mm (3")	2.510 kg	1	70162	70205	70195
900 mm (36")	141 mm (5")	5.000 kg	1	70163	70206	70196
1,200 mm (48")	168 mm (6")	8.420 kg	1	70168	70207	70197
1,500 mm (60")	203 mm (8")	12.700 kg	1	70169	70208	70198

### One-handed pipe wrench STILLSON

#### Application Benefits

- Features similar to HEAVY DUTY
- Hardened adjustment nut presses onto the handle during use and prevents undesired readjustment
- Optimised double-spring construction guarantees quick and firm self-clamping, ensuring secure hold even on smooth pipes



#### US-Norm GGG-W-651 Type I Class B



Model	Size	Weight	PU	No.	Hook
200 mm (8")	27 mm (3/4")	0.280 kg	1	70350	70374
250 mm (10")	34 mm (1")	0.590 kg	1	70351	70375
300 mm (12")	43 mm (1.1/4")	0.720 kg	1	70352	70376
350 mm (14")	48 mm (1.1/2")	1.040 kg	1	70353	70377
450 mm (18")	60 mm (2")	1.740 kg	1	70354	70378
600 mm (24")	73 mm (2.1/2")	3.080 kg	1	70355	70379
900 mm (36")	102 mm (3.1/2")	5.690 kg	1	70356	70380

## One-handed pipe wrench OFFSET PATTERN HEAVY DUTY



### Application Benefits

- Offset wrench head is ideal for working in confined spaces (e. g. near to the wall)
- One-handed ratchet-like use, self-clamping, hook spring-loaded
- Quick preset of pipe-Ø using scale on hook
- Wearing parts replaceable: hook and heel jaw can be purchased separately



Model	Size	Weight	PU	No.	Hook	Jaws
250 mm (10")	48 mm (1.1/2")	0.750 kg	1	70166	70201	70191
350 mm (14")	60 mm (2")	1.460 kg	1	70167	70203	70192

## One-handed corner pipe wrench 90°

### Application Benefits

- Features similar to HEAVY DUTY
- Weight savings of approx. 40 %: extremely light, high strength aluminium alloy



Model	Size	Weight	PU	No.	Hook	Jaws
350 mm (14")	60 mm (2")	0.895 kg	1	70115	70203	70192
450 mm (18")	73 mm (2.1/2")	1.495 kg	1	70116	70204	70194

## Chain Pipe wrench 4" R/L

### Application Benefits

- Profile handle made of drop forged chrome vanadium steel, polished head with hardened special tooth system, powerful chain made of hardened and tempered special steel
- Double-sided teeth surfaces set against the turning direction for use in both directions without re-inserting



Model	Weight	PU	No.
Chain pipe wrench 115 mm (4")	0.780 kg	1	70235

### Chain pipe wrench HEAVY DUTY

Very robust model for toughest conditions , proven in pipeline construction, jaws and handle are forged, jaws are replaceable



#### Application Benefits

- Strong chain made of tempered special steel—fits every cross-sections
- Double-sided tooth system for ratchet-like use, for right and left-handed operation



Model	Weight	PU	No.
Chain pipe wrench HEAVY DUTY, 48 mm (1.1/2")	1.400 kg	1	70242
Chain pipe wrench HEAVY DUTY, 73 mm (2.1/2")	3.500 kg	1	70243
Chain pipe wrench HEAVY DUTY, 114 mm (4")	6.700 kg	1	70244
Chain pipe wrench HEAVY DUTY, 168 mm (6")	12.600 kg	1	70245
Chain pipe wrench HEAVY DUTY, 220 mm (8")	17.200 kg	1	70246
Chain pipe wrench HEAVY DUTY, 324 mm (12")	24.200 kg	1	70247
Spare chain HEAVY DUTY, 1.1/2"	0.900 kg	1	70262
Spare chain HEAVY DUTY, 2.1/2"	0.410 kg	1	70263
Spare chain HEAVY DUTY, 4"	0.680 kg	1	70264
Spare chain HEAVY DUTY, 6"	2.170 kg	1	70265
Spare chain HEAVY DUTY, 8"	2.700 kg	1	70266
Spare chain HEAVY DUTY, 12"	3.200 kg	1	70267
Jaws for Chain pipe wrench HEAVY DUTY, 48 mm (1.1/2")	0.440 kg	1	70571
Jaws for Chain pipe wrench HEAVY DUTY, 73 mm (2.1/2")	0.580 kg	1	70572
Jaws for Chain pipe wrench HEAVY DUTY, 114 mm (4")	0.640 kg	1	70573
Jaws for Chain pipe wrench HEAVY DUTY, 168 mm (6")	2.100 kg	1	70574
Jaws for Chain pipe wrench HEAVY DUTY, 220 mm (8")	2.940 kg	1	70575

### Fittings wrench 90°

Special chrome-vanadium steel, steel forged

#### Application Benefits

- Plastic jaws guarantee a secure and gentle grip, especially for chrome-plated fittings or polished surfaces
- High-quality DURAMANT surface coating

Plastic jaws, gentle grip!



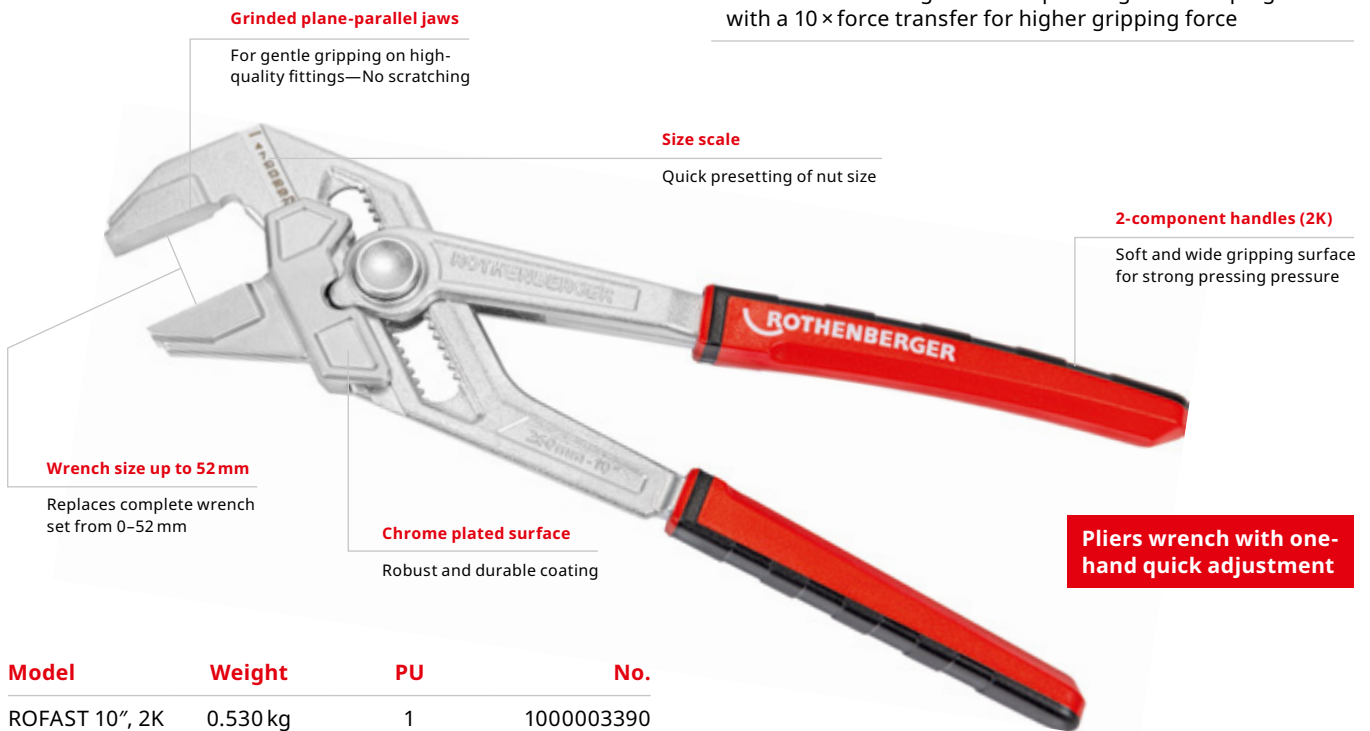
Model	Weight	PU	No.
Fittings wrench 90°, 34 mm (1")	0.740 kg	1	70545

### ROFAST pliers wrench

For gripping, holding, pressing and bending surface-sensitive, chrome-plated screw fittings

### Application Benefits

- Gentle on surfaces: Smooth, parallel jaws enable use on sensitive surfaces
- Versatile use: Replaces spanner sets from 0–50 mm or 0–1.7/8" and dispense with use of other tools
- Convenient handling: Excellent pressing and clamping force with a 10 × force transfer for higher gripping force



Model	Weight	PU	No.
ROFAST 10", 2K	0.530 kg	1	1000003390

### Fitting key

Steel forged, burnished, smooth jaws for protection of fittings and delicate or polished surfaces

### SANIGRIP / SANIGRIP PL

Special chrome-vanadium steel, steel forged, chrome-plated, 4 adjustable sizes at joint, with toothed grip jaws SANIGRIP PL version with plastic jaws to protect the fittings

### Application Benefits

- Short lever: ideal for working in confined spaces
- Steel forged: Tough and durable
- Smooth jaws without teeth: For the protection of fittings and delicate or polished surfaces

### Application Benefits

- Secure and gentle grip on valuable fittings without damaging polished surfaces
- Optimum grip is ideal for plastic screw joints up to Ø 62 mm (siphon)



Model	Weight	PU	No.
Clamping width 65 mm	0.710 kg	1	350900
Clamping width 75 mm	0.695 kg	1	350850

Model	Weight	PU	No.
SANIGRIP 14–80 mm	0.270 kg	1	70415
SANIGRIP PL 14–62 mm	0.280 kg	1	70416

## Universal tools

### Fittings wrenches

#### EASYGRIP

##### Automatic strap wrench for plastic pipes Ø 20–160 mm (3/4–6")

The indispensable tool for socket welding large diameter plastic pipes

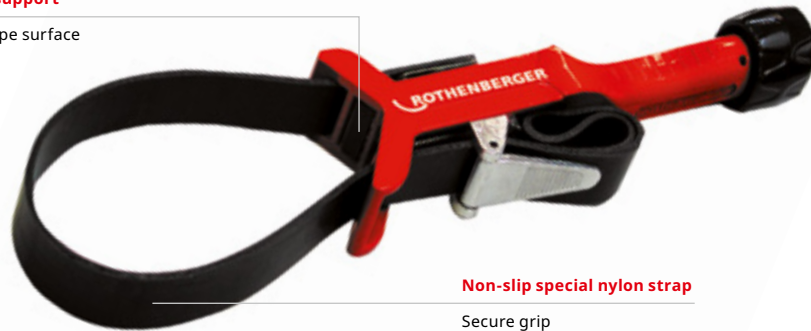
##### Application Benefits

- The indispensable tool for socketing or fixing plastic pipes with larger diameters
- No damage to pipe surface with the centred prismatic support
- Secure grip with special non-slip nylon strap



##### Centred prismatic support

No damage to the pipe surface



##### Non-slip special nylon strap

Secure grip

Model	Weight	PU	No.
EASYGRIP 20–160 mm (3/4–6")	1.000 kg	1	55075
Spare strap EASYGRIP	0.100 kg	1	55076

#### Strap and fittings wrench

##### Made of special aluminium alloy, with replaceable nylon strap

For gentle work on chrome-plated surfaces up to Ø 3" or up to 8"

##### Application Benefits

- Safe to use on chrome-plated fittings without damaging polished surfaces
- Use in the automotive industry (oil filter changes)



##### Small, compact design

Ideal for confined spaces



Model	Weight	PU	No.
Strap and fittings wrench 89 mm (3")	0.280 kg	1	70240
Strap and fittings wrench 220 mm (8")	0.280 kg	1	70241
Spare strap 8"	0.030 kg	1	70269

### UNI stepped key set

For installation and removal of radiator valve nipples, return screw connections and short tap extensions. Chrome vanadium steel, hardened, nickel-plated, square drive 1/2"

#### Application Benefits

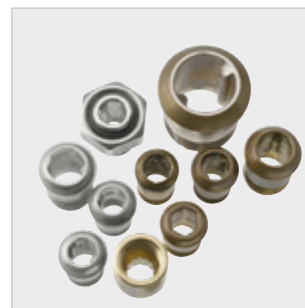
- Universally applicable: cam, internal hexagonal and 12-edged driver, sizes 3/8-1/2-3/4-1" and other sizes between
- No canting of nipples and screw connections with special stepped key design
- Combination key enables installation and removal of radiator valve nipples, return fittings and short tap extensions
- 1/2" ratchet, quick and easy installation



1/2" ratchet

Quick and easy assembly

Model	Weight	PU	No.
UNI stepped key nipples, 3/8-1/2-3/4-1"	0.120 kg	1	73298
UNI stepped key set with ratchet, 3/8-1"	0.670 kg	10	73297
Gas Stepped key	0.160 kg	1	73280
Reversible ratchet, 1/2"	0.550 kg	1	27180



### Sanitary four way key

Chrome vanadium steel

#### Application Benefits

- Four external hexagonal 3/8", 1/2", 3/4", 1" up to 100 mm and installation and removal of heating valves and tank connectors
- Three inner threads M8, M10 and M12 for hanger bolts



Model	Weight	PU	No.
Sanitary four way key with multifunctional	0.640 kg	1	351043

### Sanitary four way key

Chrome vanadium steel

#### Application Benefits

- Four external hexagonal 3/8", 1/2", 3/4", 1" up to 100 mm and installation and removal of heating valves and tank connectors
- Three inner threads M8, M10 and M12 for hanger bolts



Model	Weight	PU	No.
Sanitary four way key with multifunctional	0.590 kg	1	351044

## Universal tools

### Craftsman Standard Tool / Open-ended spanner

#### RO-QUICK

##### Valve key Release valve holder and key for eccentric and standard valves

The RO-QUICK valve key is suited for installing eccentric and standard valves in bathtubs, basins and sinks.

No damage to chrome-plated parts!



No. 70414

No. 70413

#### Application Benefits

- Quick and problem-free use by installation of bathtubs, basins and sinks
- Can be used from the bottom up
- With 2 facing, spring mounted locking cams, as well as holder with T-handle
- Adapter with star handle for showers, bathtubs (optional accessory)
- Torque-proof immediately on insertion

Model	Weight	PU	No.
RO-QUICK valve key 34 mm	0.300 kg	1	70414
RO-QUICK set	0.405 kg	1	70439
Adapter for RO-QUICK	0.070 kg	1	70413
Bathtub adapter Geberit for RO-QUICK	0.100 kg	1	70412

#### ROCLICK

##### Combined open-ended / hinged ratchet wrench

Chrome vanadium steel, polished and high shine chrome-plated

#### Application Benefits

- Can also be used in confined working positions due to movable ring ratchet
- Precise work due to fine-running ratchet (72 teeth)

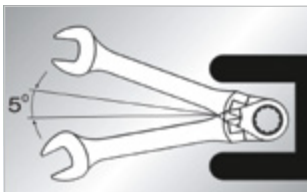


Fig. similar

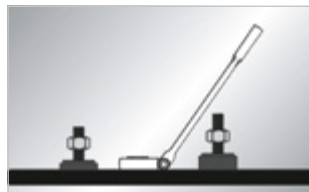


Small operating radius of only 5°!

Small 5° operating radius



Adjustable inclination angle



Model	Weight	PU	No.
ROCLICK key set 8-10-11-13-14-17-19 mm, 7 pieces	1.150 kg	1	70490



### Torque wrench set

#### For proper tightening of flange connections

Set with adjustable torque wrench (10–70 Nm) and 6 spanner inserts sizes 17, 22, 24, 26, 27 and 29 mm for flange connections on 1/4", 3/8", 1/2" and 5/8" pipe lines according to DIN EN 378- 2:2012-08

**Fix with torque  
urgently necessary!**



7 pieces set (No. 1750.01) includes: spanner wrench sizes 17–22–24–26–27–29 mm, torque wrench, carrying bag

Model	Weight	PU	No.
Torque wrench set 17–22–24–26–27–29 mm	3.500 kg	1	175001

### ROCLICK ratchet spanner

#### Chrome vanadium, head black atramentized

#### Application Benefits

- With the spring mechanism—the harder the pressure, the more firmer the grip
- Self-ratcheting effect when turning back
- Fast extraction and loosening of screws
- Suitable especially for screws on pipes, cables and rods



Model	Weight	PU	No.
ROCLICK 10 mm	0.080 kg	1	70420
ROCLICK 11 mm	0.080 kg	1	70419
ROCLICK 12 mm	0.080 kg	1	70421
ROCLICK 13 mm	0.090 kg	1	70422
ROCLICK 14 mm	0.090 kg	1	70423
ROCLICK 16 mm	0.130 kg	1	70424
ROCLICK 19 mm	0.188 kg	1	70426
ROCLICK 21 mm	0.230 kg	1	70427
ROCLICK 24 mm	0.240 kg	1	70418
ROCLICK key set 8–10–11–13–14–17–19 mm, 7 pieces	1.150 kg	1	70490

### SWO adjustable wrench

#### Chrome vanadium steel, chrome-plated and polished

For loosening and tightening screw connections.



#### Application Benefits

- Metric measuring scale on the jaws for easy determination of the sizes of nuts and bolts
- Great accessibility in confined spaces, non-protruding jaw shank at maximum opening
- Perfect gripping of nuts and bolts due to absolutely parallel jaw surfaces

Model	Weight	PU	No.
SWO, 6", 34 mm (1.3/8")	0.205 kg	1	1500001509
SWO, 8", 39 mm (1.1/2")	0.345 kg	1	1500001510
6–8", 5 pieces each	0.310 kg	1	1500001736

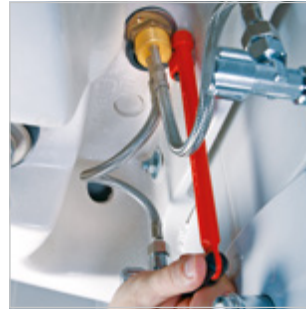
### Basin nut wrench

Chrome vanadium steel, drop forged, very tough

For moving screw nuts in hard-to-reach places

#### Application Benefits

- Optimum force transmission with T-handle
- Rotatable claw for right and left-handed rotation



Model	Weight	PU	No.
Basin nut wrench 10-32 mm (3/8-1.1/4")	0.475 kg	1	70228

### Telescopic basin nut wrench

Chrome-plated, with pivoted reversible claw for right and left-handed rotation



**Telescopic attachment, 3 x adjustable in length!**

Model	Weight	PU	No.
10-32 mm (3/8-1.1/4")	0.710 kg	1	70225
20-48 mm (3/4-1.7/8")	0.740 kg	1	70226
32-63 mm (1.1/4-2.1/2")	0.780 kg	1	70227

### Basin nut pliers

Chrome vanadium steel, forged, painted, with adjusting screw



Model	Weight	PU	No.
Basin nut pliers	0.580 kg	1	351050

### Basin nut wrench set 3/8"

The basin nut wrench set is used for loosening or tightening nuts at hard to access spots. The movable T-Grip enables a optimal use of force.



Model	Weight	PU	No.
Stand-cock nut set with extension 200 mm, T-Grip, SW 27-32-36, bag	1.050 kg	1	100109
Stand-cock nut set with extension 200 mm, T-Grip, SW 32-36-47, bag	1.200 kg	1	100110
Stand-cock nut set with extension 200 mm, T-Grip, SW 36-47, bag	1.000 kg	1	100108
Stand valve key insert SW 32	0.200 kg	1	100112
Stand valve key insert SW 36	0.250 kg	1	100113
Stand valve key insert SW 47	0.345 kg	1	100114

## EUROLINE screwdriver set







### Screwdriver set for screwing screws in and out

Blade made of chrome vanadium steel with high torque and hardness, matt chrome-plated Hardened, burnished tip with high durability for reliable force transmission even for tightly secured screws Guaranteed perfect seat on screw head, long service life even with long term use Handle made of high-quality plastic, grip-friendly AS knob form

### Application Benefits

- High force transmission with 2 component handle
- High torque
- Guarantees perfect seat on screw head
- Color coding for different tips enables quick differentiation
- Oil, fat and hydrocarbon resistant



Sets include:	Pozidriv No. 73571	Phillips No. 73570
 	3.5 × 75 mm 4 × 100 mm	3.5 × 75 mm 4 × 100 mm
 	5.5 × 125 mm 6.5 × 150 mm	5.5 × 125 mm 6.5 × 150 mm
	PZ 1 × 100 mm PZ 2 × 125 mm	
		PH 1 × 100 mm PH 2 × 125 mm

Model	Weight	PU	No.
Screwdriver set Phillips	0.700 kg	1	73570
Screwdriver set Pozidriv	0.700 kg	1	73571

**Universal tools**

**Craftsman Standard Tool**

**Chisel screwdriver set EUROLINE IMPAKT**

**Screwdriver with continuous, strengthened blade**

**Application Benefits**

- One-piece, strengthened blade with metal cap allows directed hammer blows, for example loosening stuck screws

**Set (No. 73575) includes:**

- 5.5 × 100 mm
- 6.5 × 125 mm
- 8.0 × 150 mm
- PH 1 × 80 mm
- PH 2 × 100 mm



**2 tools in 1!**

**Color coding for different tips**

Quick differentiation

**2 component handle made of high-quality, plastic, grip-friendly AS knob form**

High force transmission



**Surface treated precision tip**

Guarantees perfect seat on screw head

**Blade made of high-quality, tempered chrome vanadium steel**

High torque proof

5 pieces set (No. 73575) includes: slot screwdriver 5.5 × 100 mm (No. 73565), 6.5 × 125 mm (No. 73566), 8 × 150 (No. 73567), Phillips PH 1 × 80 mm 1 (No. 73536), PH 2 × 100 mm (No. 73537)

Constant strenghtened blade with metal cap



Model	Weight	PU	No.
Chisel screwdriver set EUROLINE IMPAKT, 5 pcs.	0.750 kg	1	73575

**VDE screwdriver set**

**Blades made of chrome vanadium molybdenum steel, thoroughly hardened, extrusion-coated blade insulation tightly joined with handle, 1,000 Volt**



Model	Weight	PU	No.
VDE screwdriver set 7 pieces	0.680 kg	1	323126

## ROCHECK

**Spirit level for angled valves For exact vertical and horizontal adjustment of fittings**

### Application Benefits

- With horizontal and head levels
- One side with 1/2" external screw thread

**Precise Installation!**



Model	Weight	PU	No.
ROCHECK spirit level for angled valves 200 mm	0.220 kg	1	70661
ROCHECK set in steel case	2.095 kg	1	70667

## ROCHECK

**Spirit level for standard distances**



Accurate installations with installation gauge for fittings, with horizontal and vertical levels, unbreakable

### Application Benefits

- For standard distances: 97-120-153-160-170-200-210 mm

**Exact Adjustment!**

Exact installation by assembling jig for braces



4 pieces set (No. 70667) includes: spirit level for angled valves 200 mm (No. 70661), spirit level for standard distances 300 mm (No. 1500004454), 1 flexible ruler 2 m (No. 252100), steel carrying case (No. 24022)

Model	Weight	PU	No.
ROCHECK spirit level for standard distances 300 mm	0.260 kg	1	1500004454

## Cartridge extractor set

**Simple extraction of cartridges in taps**

Screw the appropriate cartridge extractor on the threaded rod, attach to the cartridge, guide the cartridge body and counter piece over the thread rod, rotate the t-handle and pull the cartridge out of its seat

### Application Benefits

- Simple extraction of cartridges in taps
- 4 adaptors with hook, threaded rod, screw or rivet adaptor for cartridges made before 1979, starting in 1979 and MOEM cartridges, as well as extraction tools



Set (No. 854390) includes: T-handle (No. 854380), screw 12 x 92 (No. 854381), turning handle (No. 854382), threaded rod M10 x 130 (No. 854383), cartridge body 32 x 131 (No. 854384), cartridge extractor with thread (No. 854385), cartridge extractor with hook (No. 854386), cartridge extractor 20 x 45 (No. 854387), counter piece (No. 854388), steel carrying case

Model	Weight	PU	No.
9 pieces set	1.250 kg	1	854390

## Universal tools

### Craftsman Standard Tool / Spirit Level

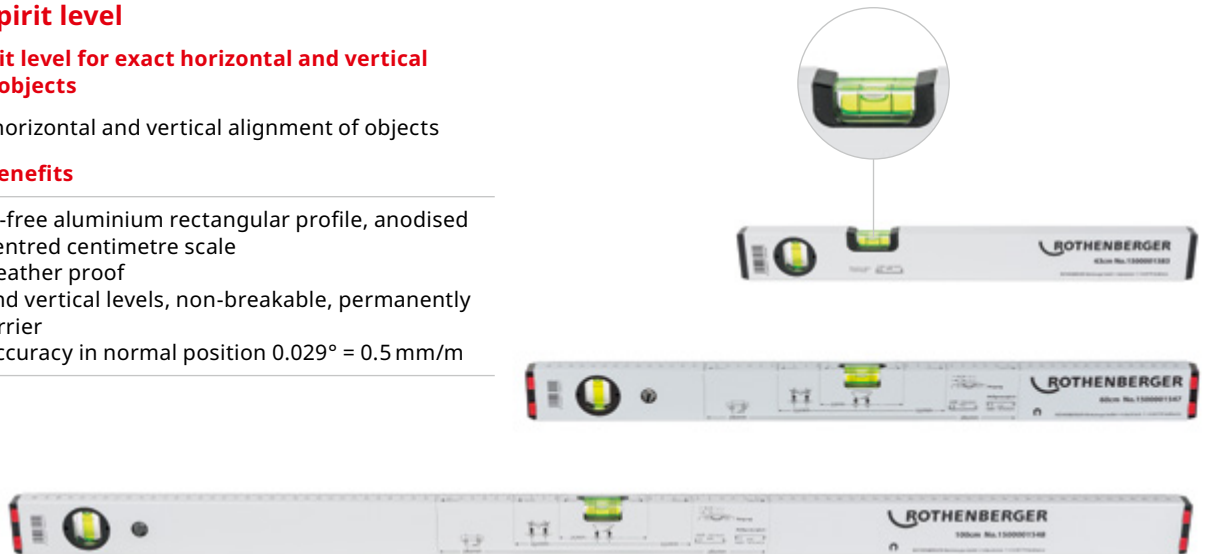
#### Standard spirit level

##### Standard spirit level for exact horizontal and vertical alignment of objects

For the exact horizontal and vertical alignment of objects

##### Application Benefits

- Deformation-free aluminium rectangular profile, anodised
- Imprinted, centred centimetre scale
- Shock and weather proof
- Horizontal and vertical levels, non-breakable, permanently aligned in carrier
- Measuring accuracy in normal position  $0.029^\circ = 0.5 \text{ mm/m}$



Model	Weight	PU	No.
Spirit level Aluminum, 400 mm, 6-dash level	0.240 kg	1	255040
Spirit level Aluminum, 600 mm, 6-dash level	0.320 kg	1	255060
Spirit level Standard, 430 mm	0.260 kg	1	1500001583
Spirit level Standard, 600 mm	0.340 kg	1	1500001547
Spirit level Standard, 1,000 mm	0.640 kg	1	1500001548

#### ROMATIC

##### Rolling measuring tape and wood folding ruler for measuring short distances with mm accuracy

##### Application Benefits

- Easy handling
- Automatic tape rewind
- With set/stop button that can be used as marker for repeated measurements



Model	Weight	PU	No.
ROMATIC tape measure, 5 m	0.230 kg	1	77397
Folding ruler, wooden, 2 m	0.100 kg	1	252100

### Electrical power combination pliers



#### Application Benefits

- Equipped with an integrated ring spanner for M8 and M10 nuts/screws
- Inductive hardened blade to ensure a higher service life
- Asymmetric grip function can be used to grab round or flat materials



Model	Weight	PU	No.
Electrical power combination pliers	0.250 kg	1	1500003163

### Electrical multi insulation stripper



#### Application Benefits

- Improvement of the common insulation stripper and does not need an adjusting screw
- Ideally suitable to strip Ø 5–16 mm cable coatings
- The stripping function enables cable stripping of single- or multicore cables up to Ø 5.0 mm



Model	Weight	PU	No.
Electrical multi insulation stripper	0.230 kg	1	1500003167

### Electrical long nose pliers



#### Application Benefits

- Inductive hardened blade to ensure a higher service life
- Integrated M10 ring spanner to tighten/loosen nuts and screws
- Grab wires precisely, the serrated gripping surface ensures a tight, firm grip



Model	Weight	PU	No.
Electrical long nose pliers	0.200 kg	1	1500003168

### Electrical edge cutter



#### Application Benefits

- Inductive hardened blade to ensure a higher service life
- Wave profile of the blade provides an anti-slip function: The wire does not slip out while being cut
- Comfortable handling thanks to ergonomic 3 K handles



Model	Weight	PU	No.
Electrical power edge cutter	0.210 kg	1	1500003164
Electrical power edge cutter	0.300 kg	1	1500003166

### Voltage Detector E-Detector 90–1000 V

#### Application Benefits

- The non-contact voltage tester detects AC voltage in a range of 90–1,000 V
- When voltage is detected, a red LED lights up. In addition, a flashlight is attached to the voltage tester.



Model	Weight	PU	No.
Voltage Detector E-Detector 90–1000 V	0.030 kg	1	1500003374

### Electrical installation pliers



#### Application Benefits

- Integrated stripping function, ring spanner and gripping zone for flat and round material
- Multi purpose tool makes lots of other tools obsolete
- Angled design enables low-fatigue working



Model	Weight	PU	No.
Ergonomic electrical installation pliers	0.290 kg	1	1500003169

**RO DD 60 cordless drill driver**

The RO DD60 cordless drill and screwdriver functions as both a screwdriver and a drill.

The RO DD 60 drill drive can be used for both screwing and drilling. High performance thanks to the powerful 4-pole-motor with 60 Nm torque (steel) and 34 Nm (wood) which can be adjusted in 20 steps.

**Application Benefits**

- Quick Change Adapter allows quick change of the tool holder for even faster work
- An additional hexagon socket enables working without a drill chuck and direct attachment of a bit.
- Precise work thanks to integrated working light, even in poor lighting conditions
- Always have the right accessories ready to use, thanks to the belt hook and bit depot

**Technical Data**

System battery	CAS
Type battery	Li-Power
Idle speed	0-450 / min
Torque hard screwcase	60 Nm
Torque soft screw case	34 Nm
Drilling diameter steel	13 mm
Drilling diameter softwood	38 mm
Battery voltage	18 V

**Quick change drill chuck**

For flexible working

**Spindle with hexagon socket**

For screwdriver bits for working without chuck



**Extra powerful**

4-pole motor for fast drilling and screwing

**Belt hook**

Optional right / left fixable

**Bit holder**

Optional right / left fixable

**LED light**

Integrated work light for illuminating the work area

**Maximum power**

Intelligent battery management with capacity indicator to control the battery level



Set (No.1000001647) includes: RO DD60 drill driver, RO BP18/2 2.0Ah battery (No. 1000001652), RO BC14/36 charger EU (No. 1000001654), quick change chuck, quick change bit holder, belt hook and bit case, ROCASE 4414 anthracite (No. 1000001949)

Model	Weight	PU	No.
RO DD 60 cordless drill driver bare tool without battery, without charger	1.910 kg	1	1000002035
RO DD 60 cordless drill driver set EU	4.320 kg	1	1000001647



### ROBIT PRO

15 pieces

#### Application Benefits

- Extensive bit set as perfect equipment for professional craftsmen
- High-quality material for heavy usage
- Adjustable belt-clip



Set (No. 1500002453) includes: 30-bit: 1/4" x 25 mm, PH: 1, 2, 2, 3 mm, PZ: 1, 2, 2, 3 mm, FD: 3, 4, 5, 6 mm, HW: 3, 4, 5, 6 mm, TX: 10, 15, 20, 25, 27, 30, 40 mm, TTX: 10, 15, 20, 25, 27, 30, 40 mm, quick release magnetic bit holder

Model	Weight	PU	No.
ROBIT PRO set 32 pieces	0.294 kg	1	1500002453

### ROBIT PRO torsion

15 pieces

#### Application Benefits

- Extensive bit set as perfect equipment for professional craftsmen
- High-quality material for heavy usage
- Adjustable belt-clip



Set (No. 1500002454) includes: 14-bit: 1/4" x 25 mm, PH: 1, 2 mm, PZ: 1, 2 mm, FD: 4, 6 mm, HEX: 3, 4, 5 mm, TX: 10, 15, 20, 25, 30 mm, quick release magnetic bit holder

Model	Weight	PU	No.
ROBIT PRO torsion bit set 15 pieces	0.140 kg	1	1500002454

### Toolbox set

For versatile applications in installation and maintenance



Set (No. 1500002764) includes: 1 x thin type lever ratchet handle with 72-teeth gear, 2 x extension bars 50 mm and 100 mm, 1 x universal joint, 1 x sliding T-head 3/8" x 1/4", 12 x sockets: 4-5-5, 5-6-7-8-9-10-11-12-13-14 mm, in soft foam and ROBOX B2350 (No. 1500002641)

Set (No. 1000002181) includes: 1 x 1-1/4" bit holder, 52 x bits 1/4" x 25 mm: 13 x star bit (torx) 5-6-7-8-9-10-15-20-25-27-30-35-40 mm, 6 x hex bit (H) 2-2.5-3-4-5-6 mm, 3 x tri wing bit 1-2-3 mm, 5-ribe bit (RM) 5-6-7-8-9 mm, 9-pentalobe bit 7-10-15-20-25-27-30-40-45 mm, 3-spline bit (M) 5-6-8 mm, 6-hex bit SAE (H) 5/64", 3/32", 7/64", 1/8", 9/64", 5/32", 4 x torq bit 4-6-8-10 mm, 4 x spanner bit 4-6-8-10 mm, in soft foam and ROBOX B2350 (No. 1000002641)

Set (No. 1000002182) includes: 10 x bits 90 mm: 2 x Phillips: 1-2 mm, 2 x Pozi: 1-2 mm, 6 x torx: 10-15-20-25-30-40 mm with color ring in soft foam and ROBOX B2350 (No. 1500002641)

Model	Weight	PU	No.
Toolkit set 17 pieces, 6-edge socket set 1/4", ROBOX	0.440 kg	1	1500002764
Toolkit set 53 pieces, safety and special bit set 1/4", ROBOX	0.435 kg	1	1000002181
Toolkit set 10 pieces, 90 mm colorbring-bit set 1/4", ROBOX	0.295 kg	1	1000002182

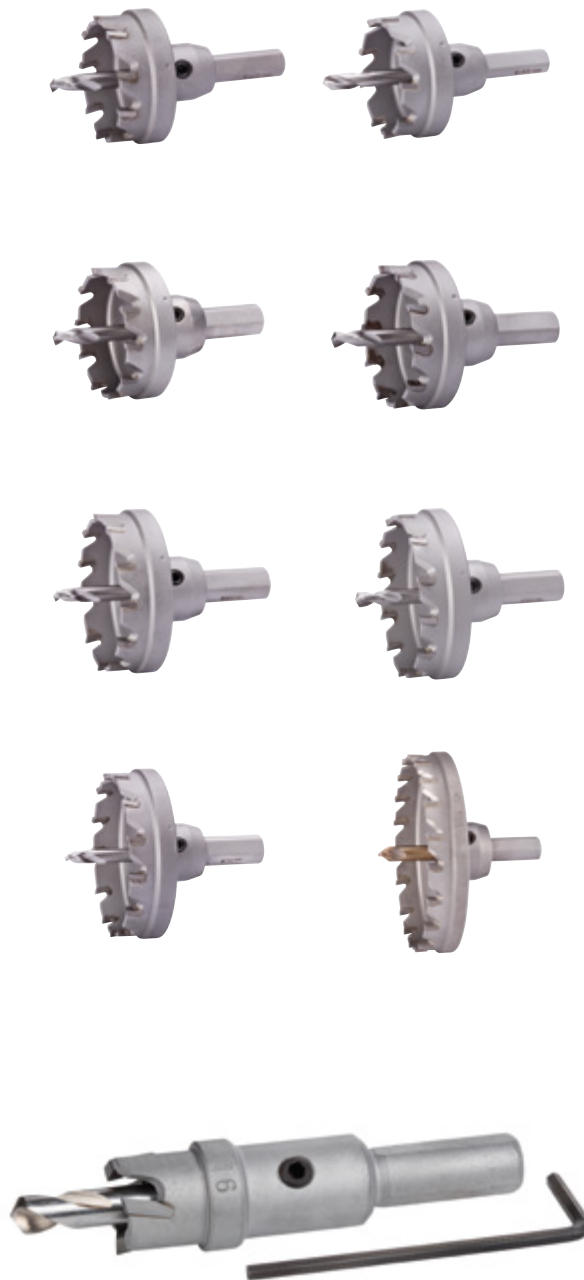
**UNICUT HM**

**Carbide-tipped hole saws for cutting circular holes  
 Ø 16–140 mm (5/8–5.1/2") without impact**

For stationary and free-hand cutting of circular holes. For iron, steel, V2A–V4A, cast iron, copper, bronze, aluminium, zinc, plastic, fibre-glass, chipboard and wood, light construction plaster boards without impact.

**Application Benefits**

- For use even in high-speed hand drills and stand-mounted drilling machines due to anti-slip shank
- Positive cutting angle for good chip removal
- Includes adaptor holder and replaceable HSS Co5 centring drill, up to 4 mm sheet thickness and cutting depth 10 mm



14

Model	Weight	PU	No.
UNICUT HM 16 mm (5/8")	0.100 kg	1	21316
UNICUT HM 19 mm (3/4")	0.114 kg	1	21319
UNICUT HM 34 mm	0.180 kg	1	21334
UNICUT HM 35 mm (1.3/8")	0.190 kg	1	21335
UNICUT HM set 22–25–28–32–35 mm	0.950 kg	1	21300
Spare centering pin HSS 8 mm	0.017 kg	1	21395



## RO ID 400 cordless impact wrench

Screws or hex nuts can be mounted or dismantled at top speed. Profiles of the pre-wall installation or sprinkler systems are thus no longer a challenge

Battery-powered impact wrench for tightening and loosening screws and nuts

### Application Benefits

- Brushless motor: For fast work progress and maximum efficiency in every application
- Extremely high torque: With handy design
- Twelve speed/rotation levels: For a wide range of applications
- Always have the right accessories ready to use, thanks to the belt hook and bit depot

### Technical Data

System battery	CAS
Type battery	Li-Power
Stroke number	4,250 / min
Idle speed	0-2,150 / min
Weight with battery	2.110 kg
Battery voltage	18 V

#### High torque

With handy design

#### Belt hook

Optional right / left fixable

#### Twelve speed/torque levels

For a wide range of applications

#### Maximum power

Intelligent battery management with capacity indicator to control the battery level

#### Brushless motor

For fast work progress and maximum efficiency in every application

#### Bit holder

Optional right / left fixable



No. 1000001949

Set (No. 1000001648) includes: RO ID400 impact wrench, RO BP18/2 2.0Ah battery (No. 1000001652), RO BC14/36 charger EU (No. 1000001654), bit holder, belt hook, RO CASE 4414 anthracite (No. 1000001949)

### Model

	Weight	PU	No.
RO ID 400 cordless impact wrench set EU	1.500 kg	1	1000001648
RO ID 400 cordless impact wrench bare tool without battery, without charger	2.280 kg	1	1000002036

### RO AG 8000 cordless angle grinder

Smaller work steps, such as the rough removal of hanger bolts or the cutting of a U-profile are easily and quickly handled. The slim design and the rotatable battery allow work in confined spaces and simplify work areas such as disassembly.

The RO AG8000 cordless angle grinder is the ideal tool for processing of thin sheets, steel cables, thin-walled profiles and pipes made of stainless steel and metals and composites



#### Application Benefits

- Slim design for low-fatigue working in confined spaces or overhead.
- Save time with a tool-free adjustable protective hood, as well as tool-free disc replacement
- Removable dust filter protects the motor from coarse particles

#### Technical Data

System battery	CAS
Type battery	Li-Power
Idle speed	8,000 / min
Weight with battery	2.400 kg
Battery voltage	18 V



No. 1300003338

Set (No.100001649) includes: RO AG8000 angle grinder, RO BP18/4 4.0Ah battery (No. 1000001653), RO BC14/36 charger EU (No. 1000001654), guard, quick-locking nut, side handle, dust filter, ROCASE 4414 anthracite (No. 1000001947)

Model	Weight	PU	No.
RO AG 8000 cordless angle grinder bare tool without battery, without charger	1.700 kg	1	1000002037
RO AG 8000 cordless angle grinder set EU	4.575 kg	1	1000001649

**PROFI PLUS cutting disc**

For burr-free and quick cutting of stainless steel, steel, cast iron and stone

Model	No.	Alloyed and unalloyed steel	High strength steel	Tool steel	Rust- and acid-resistant steel	Edged steel profiles	Steel panel	Welded joints	Edged stainless steel profiles	Cast	Aluminium alloying	Copper	Brass/bronze
Cutting disc INOX PROFI PLUS (115 × 1 × 22)	071533D	✓	✓	✓	✓✓	✓	✓	✓	✓	✓	✓✓	✓✓	✓✓
Cutting disc INOX PROFI PLUS (125 × 1 × 22)	071534D	✓	✓	✓	✓✓	✓	✓	✓	✓	✓	✓✓	✓✓	✓✓

✓✓ = very well suited    ✓ = well suited    ✓ = partially suited

**PROFI PLUS cutting disc**

For burr-free and fast cutting of stainless steel, steel, cast iron and stone



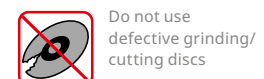
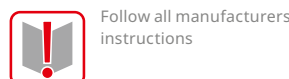
For thin sheet metal (e.g. in car body, tank and container construction), steel cables, thin-walled profiles and pipes made of stainless steel and non-ferrous metals, composite materials (GRP) and high-temperature materials.

**Application Benefits**

- Very thin (1 mm): Allows a clean cut with minimal effort in short time
- Best results: Milimetre accurate use, vibration-free operation, no thermal blue discoloration and no burr formation



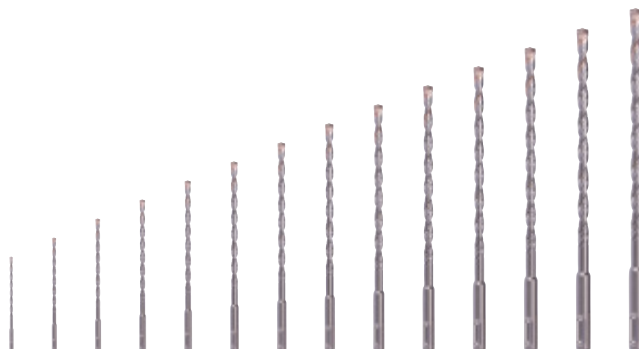
Model	Weight	PU	No.
PROFI PLUS cutting disc INOX, 115 × 1, 10 pieces, box	0.335 kg	1	071533D
PROFI PLUS cutting disc INOX, 125 × 1, 10 pieces, box	0.395 kg	1	071534D



### SDS-plus hammer drill

**For drilling in granite, concrete, concrete reinforcement, clinker, stone, masonry and marble**

Application area: for granite, concrete, concrete reinforcement, clinker, stone, masonry and marble  
 Application: In all rotary hammers with SDS-plus receptacle and 2-slot receptacle such as ROTHENBERGER RO RH4000



Model	Weight	PU	No.
6 × 110 mm	0.490 kg	1	111405
6 × 160 mm	0.440 kg	1	111406
8 × 110 mm	0.050 kg	1	111411
8 × 210 mm	0.070 kg	1	111413
10 × 110 mm	0.070 kg	1	111418
10 × 160 mm	3.980 kg	1	111419
12 × 160 mm	0.090 kg	1	111424
12 × 260 mm	0.150 kg	1	111426
12 × 460/410 mm	0.700 kg	1	111427
14 × 260 mm	0.180 kg	1	111432

Model	Weight	PU	No.
15 × 160 mm	0.135 kg	1	111429
16 × 210 mm	0.340 kg	1	111439
16 × 300 mm	0.170 kg	1	111440
18 × 250 mm	0.440 kg	1	111445
18 × 450/410 mm	0.700 kg	1	111447
20 × 450 mm	0.060 kg	1	111450
22 × 450 mm	0.640 kg	1	111452
24 × 460/410 mm	0.700 kg	1	111454
25 × 450 mm	0.060 kg	1	111455

### Chisel

**High-quality, fully coated steel chisels with high life time. The construction and cutting edge geometry enable a heavy stock removal**



No. 1500002828



No. 1500002827



No. 1500002826



No. 1500002825



No. 1500002824

Set (No. 1500002829) includes: flat chisel SDS-plus (No. 1500002825), sharp chisel SDS-plus (No. 1500002826), tile chisel SDS-plus, 40 mm (No. 1500002828), ROBOX B2650 (No. 1000002763)

Model	Weight	PU	No.
Tile chisel 80 mm SDS-plus 170 mm	0.385 kg	1	1500002824
Flat chisel SDS-plus 250 mm	0.270 kg	1	1500002825
Sharp chisel SDS-plus 250 mm	0.250 kg	1	1500002826
Hollow chisel 22 mm SDS-plus 250 mm	0.300 kg	1	1500002827
Tile chisel 40 mm SDS-plus 250 mm	0.300 kg	1	1500002828
Chisel set, 3 pcs. SDS-plus with ROBOX	1.000 kg	1	1500002829



## RO FL 180 cordless LED lamp

The RO FL180 is the perfect companion for the sanitary and heating installer. Due to the size and the different setting functions, the RO FL180 provides the perfect light and facilitates the daily work of the professional tradesman

### Application Benefits

- Powerful LED rod lamp for uniform, bright working light
- Compact and handy for versatile use
- Lamp head can be rotated and swiveled 180° for virtually unlimited lighting positions
- Rotatable hook for hanging the lamp

### Technical Data

System battery	CAS
Max operating time per battery charge (18V/8.0Ah)	9.1 h
Luminous flux	440 lm
Battery voltage voltage unit	18 V

### Powerful LED inspection lamp

For uniform, bright illumination of the working area

### Robust aluminum die-cast housing

For easy use in confined spaces

### Rotatable lamp head

Can be turned and swiveled through 180° providing almost infinite positions for the lamp

### Compact and handy

For versatile use

### Maximum power

Intelligent battery management with charge indicator to control the status of charge



Set (No.1000001651) includes: RO FL180 LED lamp, RO BP18/2, 2.0 Ah battery (No. 1000001652), RO BC14/36 charger EU (No. 1000001654), RO CASE 4212 anthracite

Model	Weight	PU	No.
RO FL 180 cordless LED lamp without battery, without charger	1.570 kg	1	1000001734
RO FL 180 cordless LED lamp EU	2.540 kg	1	1000001651

### AMPSHare battery packs and charger

All AMPShare battery packs and chargers are fully compatible with tools and machines of the cross-brand AMPShare community—including the entire Bosch Professional 18 V system. The leading battery technology guarantees powerful performance, exceptionally long service life and fast charging technology.



Powered by **BOSCH**

#### Application Benefits

- Coolpack technology with fast heat removal ensures longer service life and long running times
- Compact and lightweight for ergonomic working
- ProCore 18V batteries with even more power for the toughest Applications



No. 1000003859



No. 1000003860



No. 1000003864



No. 1000003863



No. 1000003858



Model	Weight	PU	No.
RO BP18/2, 2.0 Ah 18V	0.400 kg	1	1000003859
RO BP18/4, 4.0 Ah 18V	0.600 kg	1	1000003860
RO BP18/4, 4.0 Ah 18V, ProCORE	0.520 kg	1	1000003863
RO BP18/8, 8.0 Ah 18V, ProCORE	0.960 kg	1	1000003864
RO BC18 charger, 230 V	0.550 kg	1	1000003858



### CAS battery packs and charger

All machines, battery packs and chargers of the CAS system can be easily combined across manufacturers. Powerful 18-volt battery technology in Li-Ion or Li-HD version from 2.0 Ah to 8.0 Ah capacity. The Li-HD version covers a power range of up to 3,200 watts, for particularly energy-intensive applications.



#### Application Benefits

- Intelligent battery management with permanent electronic single cell protection (ESCP) during charging—for particularly long service life
- Level gauge to check battery capacity
- Li-HD versions with extra robustness thanks to rubber buffers between the cells and outer rubber coating of the battery pack as shock protection



No. 1000001652



No. 1000001653



No. 1000002549



No. 1000002548



No. 1000001654

Model	Weight	PU	No.
RO BP18/2, 2.0 Ah 18 V	0.420 kg	1	1000001652
RO BP18/4, 4.0 Ah 18 V	0.575 kg	1	1000001653
RO BP18/4, 4.0 Ah 18 V, Li-HD	0.515 kg	1	1000002548
RO BP18/8, 8.0 Ah 18 V, Li-HD	0.915 kg	1	1000002549
RO BC14/36 charger, 230 V	0.580 kg	1	1000001654



### Fitter's hammer

According to DIN 1041, hickory wooden handle, head secured by sealed shaft



Use the Fitter's hammer for chiselling and driving in nails and dowels as well as for joining components



Model	Weight	PU	No.
Fitter's hammer	0.470 kg	1	322823

### Lump hammer

According to DIN 6475, hickory wooden handle, cast handle for head protection



Complies with DIN 6475, hickory wooden handle, head secured by sealed shaft



Model	Weight	PU	No.
Lump hammer	1.380 kg	1	322922

### Chisel

Safety tempered impact head prevents splintering off the chisel head

#### Application Benefits

- Silver lacquered tip
- Chrome-manganese-silicon-steel



Model	Weight	PU	No.
Mason chisel, flat	0.560 kg	1	77050

### Parallel vice

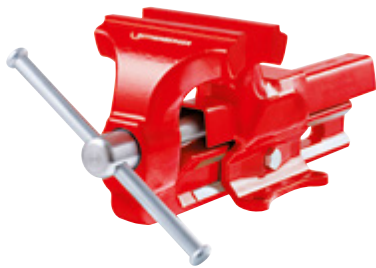
**With forged and hardened pipe clamping jaws, steel forged underneath the parallel vice jaws**



The parallel vice is ideally suited for clamping pipes of all types with Ø 3/8–2"

#### Application Benefits

- Non-breakable
- Protected, powerful spindle with trapezoidal thread
- Re-adjustable prismatic guide on both sides
- Anvil base for levelling and compressing work



Model	Weight	PU	No.
Parallel vice 16–55 mm (3/8–1.1/2")	8.700 kg	1	070705X
Parallel vice 27–70 mm (3/4–2")	15.600 kg	1	070735X

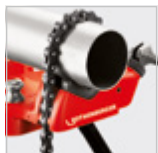
### Chain pipe vice

**Tough, powerful design with V-shaped support, bending device and pipe support, wear-resistant clamping jaws are forged and hardened, powerful chain, quick fastening due to offset lever and pre-tensioning screw, simple conversion to other pipe diameters, extremely robust powder epoxy coating**



#### Application Benefits

- V-shaped pipe supports with teeth and bridge prevent undesired bending during clamping
- Exchangeable jaws



Model	Weight	PU	No.
10–76 mm (1/8–2.1/2")	3.800 kg	1	70713
10–114 mm (1/8–4")	6.200 kg	1	70714
10–165 mm (1/8–6")	9.300 kg	1	70715

### Pipe vice

**Foldable, with automatic closing hook, upper clamping jaw and lower support jaws milled and hardened. Powerful smooth-running spindle. Durable epoxy-powder coated**



Foldable pipe vice for non-slip and deformation-inhibiting clamping of pipes with Ø 1/8–4" of all material types

#### Application Benefits

- Reliable hold: Pipe support and movable upper clamping jaw



Model	Weight	PU	No.
10–60 mm (1/8–2")	3.700 kg	1	70710
10–89 mm (1/8–3")	7.900 kg	1	70712
10–114 mm (1/8–4")	11.730 kg	1	70711

### ROBOY clamping workbench

**For on-site repair and service work**

#### Application Benefits

- Portable, handy and practical workbench with the smallest dimensions
- Mountable on door frames or free-standing walls: Prevents floors damage and saves space
- Pressure plate is coated with rubber to protect against damage
- Spindle with trapezoidal thread allows quick adjustment
- With height-adjustable support pipe for additional stability



Parallel vice (No. 070705X) and rotatable table not included

Model	Weight	PU	No.
ROBOY 650 × 400 mm	14.900 kg	1	70700

### Tripod uni workbench

With/without integrated chain vice

#### Application Benefits

- Collapsible, extremely stable frame
- Attachment of various tools is possible
- Screw fixture for 1" pipe to enable overhead support of the unit with integrated chain vice
- Bending of pipes Ø 3/8-1/2-7/8" without integrated chain vice
- Bending of pipes Ø 3/8-1/2-3/4"
- Universal vice attachments applicable for pipe vice (No. 70710) and chain pipe vices (No. 70713, 70714, 70715)



Model	Weight	PU	No.
Tripod universal workbench with chain vice	16.000 kg	1	70752
Tripod universal workbench without chain vice	15.300 kg	1	70751

### Telescopic workbench

Workbench for all kinds of work

#### Application Benefits

- Stable, collapsible tubular steel frame with smallest dimensions
- Portable, handy and practical
- With tough beech wood plate for an optimum work surface, steel edges all around: Ideal for vice work
- Individually extendable legs allow easy working even on stairs



Model	Weight	PU	No.
Telescopic workbench 700 × 450 × 30 mm	17.400 kg	1	070699X

### Working tool 1/8-2"

With pipe vice

#### Application Benefits

- Collapsible, stable, non-slip frame
- With folding pipe vice, bending holes and large tool tray



Model	Weight	PU	No.
Working tool 1/8-2"	21.000 kg	1	70740

### Universal workbench

Workbench for all kinds of work

#### Application Benefits

- Stable and tough, easy to transport: collapsible tubular frame
- Optimum work surface: work plate made of processed beech wood
- Model "Pipe-fitter" steel edges all around: ideal for vice machining



Model	Weight	PU	No.
Pipe-fitter 1,000 × 700 × 835 mm	32.000 kg	1	70696
Pipe-fitter 1,200 × 750 × 835 mm	38.000 kg	1	70698
Installer 1,200 × 550 × 835 mm	30.000 kg	1	070690X

### Hemp dispenser

For sealing thread connections in water or gas installations



Model	Weight	PU	No.
Hemp dispenser with roll, 40 m	0.060 kg	1	70623

### Carpenter pencil

Suitable for marking, sketching or writing on wood, paper, tiles and glass



Model	Weight	PU	No.
Carpenter pencil	0.020 kg	1	856907

### Cutter knife

For cutting plastics, fabrics, paper and similar materials

#### Application Benefits

- Rubberised handle
- Locking device
- 4 blades included



Model	Weight	PU	No.
Cutter knife with 4 blades, 18 mm	0.110 kg	1	150000087
Blades for cutter knife (10 pcs.)	0.075 kg	1	1500001299

### Trendy tool bag

Tool bag with plenty of storage space for all tools. Comfortable to carry with handle and shoulder strap



Model	Weight	PU	No.
Trendy tool bag 380 × 300 × 370 mm	1.880 kg	1	402311

### Tool bag

Sturdy tool bag with enough space for the most important tools



Model	Weight	PU	No.
Tool bag 450 × 285 × 335 mm	2.300 kg	1	1500001320

## Universal tools

### Hand tool sets

#### Tool bag small

**Sturdy tool bag with enough space for the most important tools**

The tool bag is also suitable for heavy tools, as the plastic base is particularly firm and stable. It offers enough space for the necessary tools in customer service use or also for repairs and new building installations

##### Application Benefits

- Offers many storage compartments and tool holders
- Waterproof bottom included
- Volume approx. 15 l



Model	Weight	PU	No.
Tool bag small, 280 × 360 × 230 mm	1.500 kg	1	1500002182

#### Trendy shoulder toolbox

**Tool shoulder bag for the most important tools. With many compartments and an adjustable shoulder strap**

The practical tool shoulder bag is ideal for transporting hand tools

##### Application Benefits

- Lots of storage room for all your tools



Model	Weight	PU	No.
Trendy shoulder toolbox 250 × 220 × 140 mm	0.580 kg	1	402308

#### Assembly toolbox 5 pieces

**Tool bag with a lot of pockets and tool holders with a waterproof plastic bottom. The set offers a good selection of high quality tools for every craftsman**

The practical tool box contains all the tools for pipe processing

##### Application Benefits

- Diverse: Extensive and practical tool kit
- Portable: Practical and robust carrying case made of galvanized steel



Model	Weight	PU	No.
Assembly toolbox 5 pieces	4.730 kg	1	402312

#### Tool bag universal

**Tool shoulder bag for the most important tools. With many compartments and an adjustable shoulder strap**

The practical tool shoulder bag is ideal for transporting hand tools

##### Application Benefits

- Very light handy bag for the most important tools
- Volume approx. 11 l



Model	Weight	PU	No.
Tool bag universal, 220 × 440 × 230 mm	0.700 kg	1	1500002230

### Apprentice set 50 pieces

**Tool bag with a lot of pockets and tool holders with a waterproof plastic bottom. The set offers a good selection of high quality tools for every craftsman**

The practical tool box contains all the tools for pipe processing

#### Application Benefits

- Extensive and practical tool assortment
- Case made of galvanized steel
- Dimension: 530 × 200 × 200 mm



Fig. similar

Set (No. 19166) includes: water pump wrench type SP 10", corner pipe wrench Super S (1"), ALU-spirit level, anodized (500 mm), hacksaw frame (300 mm), 10 × HSSE 4 PLUS saw blades, fitter's hammer (300 g), lump hammer (1,250 g), PUK-hacksaw (290 mm) + 12 × saw blades, basin nut wrench, stone chisel flat (300 × 16 mm), Ratched key ROCLICK 19 mm, UNI-stepped key + ratchet, EUROLINE screwdriver set (Phillips), chassis punch (32 mm round), wooden ruler (2 m), carpenter pencil, TUBE CUTTER 35 (6–35 mm), MINICUT I PRO (3–16 mm), extension key, corner pipe wrench Super S (1.1/2"), cutter knife, ROGRIP F 10", 1K, installer toolbox, dimensions: 530 × 200 × 200 mm

Model	Weight	PU	No.
Apprentice set 50 pieces	14.000 kg	1	19166

### General purpose tools set 57 pieces

**Tool bag with a lot of pockets and tool holders with a waterproof plastic bottom. The set offers a good selection of high quality tools for every craftsman**



Set (No. 1000001425) includes: TUBE CUTTER 35 DURAMAG (6–35 mm), UNI-step-ped key + ratchet, Uni-small saw PUK, 10 × saw blade for PUK-saw metal, saw bow ROBO Super, 10 × saw blades BI-METALL HSSE 4 Plus, Ratched key ROCLICK 19 mm, EUROLINE screwdriver set (2 × PH, 4 × Sslot), spirit level, carpenters pencil, flexible ruler, MINICUT I Pro (3–16 mm), profi universal knife, hammer with hickory wooden handle, electrician chisel, flat, sanitary four way key, ROGRIP M XL (3.1/2"), ROGRIP M 10", 1K, ROGRIP M 7", 1K, ROCUT TC 42 (0–42 mm), SWO adjustable wrench 8", tool bag (450 × 285 × 335 mm)

Model	Weight	PU	No.
General purpose tools set 57 pieces	10.342 kg	1	1000001425

### General purpose tools set 17 pieces

**Tool bag with a lot of pockets and tool holders with a waterproof plastic bottom. The set offers a good selection of high quality tools for every craftsman**



Set (No. 1000001745) includes: EUROLINE screwdriver set, water pump pliers SP 10", water pump pliers SP 7", professional cutter knife, MINI MAX Tube Cutter, 3–28 mm, GRATFIX HSS with spare blade, sanitary four way key multifunctional 3/8–1", flexible ruler, wooden, 2 m, aluminum spirit level, carpenter pencil, safety glasses UVEX, tool bag (280 × 360 × 230 mm)

Model	Weight	PU	No.
General purpose tools set 17 pieces	4.300 kg	1	1000001745






**ROCASE case system**

**Application Benefits**

- Time saving on the construction site: Easily transport multiple cases at the same time due to one-click connection
- For robust use: made of durable ABS plastic
- Clever features: Foldable handle, shoulder strap and eyelet to lock the ROCASE
- Four different case sizes: perfectly matched to various ROTHENBERGER tools



**Overview case system**

	ROCASE 4212	ROCASE 4407	ROCASE 4414	ROCASE 6414	ROCASE 6427
					
	No. 1300003334	No. 1300005506	No. 1300003541	No. 1300003336	No. 1300003337
Outer dimension	390 × 190 × 120 mm	390 × 190 × 70 mm	390 × 190 × 140 mm	590 × 390 × 140 mm	590 × 390 × 270 mm
Inner dimension	377 × 150 × 100 mm	349 × 356 × 51 mm	348 × 352 × 122 mm	548 × 352 × 122 mm	548 × 352 × 250 mm
Volume	5.7l	6.3l	14.9l	23.5l	48.2l
Weight	0.630 kg	1.200 kg	1.300 kg	1.890 kg	2.640 kg
Color	red, anthracite	red	red, anthracite	red	red
Quantity of inlays	7		16	6	3



Model	Weight	PU	No.
ROCASE 4212 red, without inlay, 39 × 19 × 12 cm	0.630 kg	1	1300003334
ROCASE 4212 anthracite, without inlay, 39 × 19 × 12 cm	0.634 kg	1	1300003649
ROCASE 4407 red, without inlay, 39 × 19 × 12 cm	1.200 kg	1	1300005506
ROCASE 4414 red, without inlay, 39 × 39 × 14 cm	1,554 kg	1	1300003541
ROCASE 4414 anthracite, without inlay, 39 × 39 × 14 cm	1.303 kg	1	1300003338
ROCASE 6414 red, without inlay, 59 × 39 × 14 cm	1.890 kg	1	1300003336
ROCASE 6427 red, without inlay, 59 × 39 × 27 cm	2.640 kg	1	1300003337



### ROCASE 4407

The ROCASE with a transparent lid is compatible with the other cases. In the inside of the case there is a structure to fix the ROBOXes

The ROCASE 4407 is ideal for use on the worksite to perfectly organise small parts.

#### Application Benefits

- Optimisation of the daily work because items are perfectly organised into the case



Model	Weight	PU	No.
ROCASE 4407 with ROBOX	1.700 kg	1	100002625

### ROBOX

The ROBOX system contains different box sizes that can be inserted into the ROCASE 4414. The ROBOX is made of robust ABS plastic and is held firmly in place in the ROCASE by a specially developed inlay



No. 1500002763



No. 1000002108

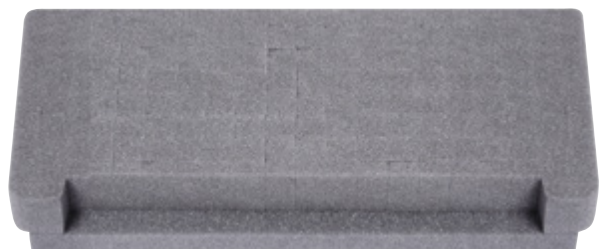


No. 1000002109

Model	Weight	PU	No.
ROBOX B2350 red	0.096 kg	1	1500002779
ROBOX B2350 192 × 114 × 50 mm	0.096 kg	1	1500002641
ROBOX B2650 364 × 114 × 50 mm	0.150 kg	1	1500002763
ROCASE 4414 with 2 inlays for ROBOX	2.100 kg	1	1000002012
ROCASE 4414 with 2 inlays and ROBOXES	3.695 kg	1	1000002108
ROBOX set for ROCASE 4414	1.000 kg	1	1000002109

**Foam inlay for ROCASE 4212**

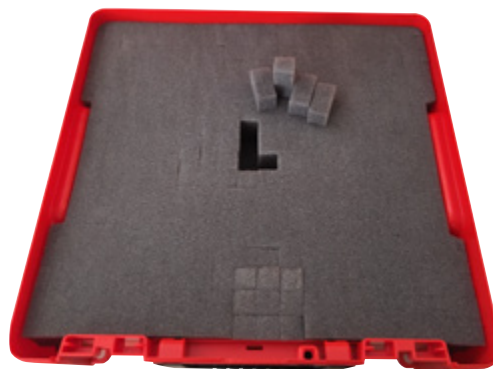
The foam inlay is designed to be used in the ROCASE 4212 to safely store other high quality products for transportation



Model	Weight	PU	No.
Foam inlay for ROCASE 4212	0.100 kg	1	1500002449

**Foam inlay for ROCASE 4414**

The foam insert is designed for use in the ROCASE 4414 to safely store other high value products for transport



Model	Weight	PU	No.
Foam inlay for ROCASE 4414	0.200 kg	1	1500002450

**ROCASE shoulder belt with logo**



Model	Weight	PU	No.
ROCASE shoulder belt with logo	0.177 kg	1	1500002239

**ROCASE Trolley**



Model	Weight	PU	No.
ROCASE trolley 78 × 48.5 × 6 cm	7.000 kg	1	1000002628

## ROBUCKET

The ROBUCKET is a tool bucket for versatile use and can be fixed on ROCASE. To sort small parts, the ROBOX B2650 can be used in the upper section

The ROBUCKET is a tool bucket for versatile use on the worksite

### Application Benefits

- Wide handle allows comfortable transport
- ROBOX B2650 can be stored inside the bucket to stow accessories
- Liter indicator inside the bucket
- Belt mount for shoulder straps



Model	Weight	PU	No.
ROBUCKET with ROBOX	1.600 kg	1	1000002627

## Hand tool kit in ROCASE

Hand tool set in the ROCASE for common installation work in the SHK area



### Application Benefits

- Wide and practice-oriented tool range
- Dimensions: 390 x 390 x 140 mm



Set (No. 1000001955) includes:

TUBE CUTTER 35 DURAMAG, ROCUT TC 42, ROGRIP M 7", 1K, ROGRIP M 10", 1K, ROGRIP XL, pipe wrench 1", uni stepped key set and ratchet, SWO, 8" adjustable wrench, EUROLINE screwdriver set, standard spirit level 430 mm, ROMATIC and ruler, shoulder belt with logo, in ROCASE completely

Model	Weight	PU	No.
Hand tool kit 4414 18 pieces	10.500 kg	1	1000001955

# Alphabetical index

Item	Page	Item	Page	Item	Page	Item	Page
3-piece pressure hose sets	313	Corner pipe wrench 45° SUPER S	337	General purpose tools set 17 pieces	367	One-handed pipe wrench STILLSON	338
<b>A</b>							
Adaptor magazine for R 600/650	259	Cross-blade cutter, serrated	264, 266	General purpose tools set 57 pieces	367	Oxy-acetylene hoses	194
AIRPROP brazing set	182	Cutter knife	365	GRATFIX HSS	42	Oxygen refilling bend	195
ALLGAS 2000 PS 0,5/2 Basic	191	Cutter wheels	37	Grease cutter	266	<b>P</b>	
ALLGAS 2000 PS 0,5/2 Compact	189	Cylinder pressure reducer	195	Groove water pump pliers CL	335	Parallel vice	363
ALLGAS 2000 set	188	Cylinder transport trolley	194	Guidance balls	235	Peeling device	300
ALLGAS 2000 welding tips	189	<b>D</b>		Hand roll groover 1-12"	168	PIPECUT mini	38
ALLGAS Mobile Pro	190	Deburring adapter	41	Hand saw blade HSSE 4 PLUS	40	Pipe cutters, cutting wheels and spare parts	29
AMPShare battery packs and charger	360	Demineralization cartridge PURE H2O	244	Hand tool kit in ROCASE	371	Pipe roughing wrench	167
Analog manifolds	312	Double clamp short	301	Handtool set "Prepare to Press"	21	Pipe supporting column	167
Apprentice set 50 pieces	367	Drop-head auger	265	Hand wire brushes	197	Pipe vice	363
Assembly toolbox 5-part	366	Dry drill bits:	48	Hard solder paste LP 5	200	Pipe wrench 90°	337
Automatic pipe cutter	16, 25	DX High Speed Dry	48	Hard solder powder HKM	200	Plastic pipe chamfering unit	303
<b>B</b>							
Ball head cutter	268	DuraFlex spiral and tool set	271	Hard solder rings	200	Plate fin comb	323
Basin nut pliers	346	DuraFlex spirals	263, 271	HD 13/100	273	Precision die heads	166
Basin nut wrench	346	DX High Speed Dry	50	HD 17/190	273	Precision double flaring press DB 10	113
Basin nut wrench set 3/8"	346	DX High Speed Dry 1.1/4" UNC	51	Heating spigots and sockets (Form A) for P63 S-6	297	Press chains standard	138
Bending segment for ROBULL type E	83, 85	DX High Speed Dry 1/2"	52	Heating spigots and sockets for ROWELD P125	298	Press jaws compact	134
Bending spray	79	DX-HIGH SPEED Plus universal drill bits	62, 63	<b>E</b>			
Blowback prevention	195	<b>E</b>		Hemp dispenser	365	Press jaws compact >B< MaxiPro	132
Bottle connection and adaptors	322	EASYGRIP	342	High-pressure hose	274	Press jaw sets >B< MaxiPro	130
Brush attachments	235	Electrical edge cutter	351	High Speed Plus Natural Stone	61, 62	Press jaws standard	136
Bulb auger	264	Electrical installation pliers	351	HM-cutter clade inserts	37	Press jaws standard >B< MaxiPro	132
Bulb auger long	265	Electrical long nose pliers	351	Hydraulic expander system H 600	105	Press jaws standard 3-elemental	137
Bulb auger short	265	Electrical multi insulation stripper	351	<b>I</b>			
Burners cleaner	196	Electrical power combination pliers	351	Injector suction hose for cleaning agent	275	Press rings	133
Butt welding workshop machines	286	Electro-hydraulic expander pistol H1	106	Interchangeable press jaw compact	135	Press rings >B< MaxiPro	133
<b>C</b>							
Calculation examples ROBEND 4000/ROBEND 4000 E	92	ENORM 4"	27	Internal brushes for copper pipe	197	PRISMACUT	54
Calculation examples TUBE BENDER MAXI	91	EUROLINE screwdriver set	347	Internal deburrer with ratchet	167	PRO BENDER	77
Carbide-tipped cutter	268	Expander A0	102	<b>L</b>			
Carbide-tipped cutters	264	Expander adaptor type S	103, 106	Leak detection spray	215	Professional sets	336
Carpenter pencil	365	Expander head ROLOCK	100	Lightweight steel cylinders, filled	194	PROFI PLUS cutting disc	357
Cartridge extractor set	349	Expander head standard	101	Lump hammer	362	Propane hoses	185
CAS battery packs and charger	361	Expander head type S	103	<b>M</b>			
Chain pipe cutter	17, 26	Extension modules	233	Magnet welding mirror	196	Propane regulators	185
Chain pipe vice	363	Extensions	184	Manifold sets	312	Propane steel cylinder	185
Chain Pipe wrench 4" R/L	339	Extensions for drill bits 1.1/4" UNC	68	Manual drain cleaner type 3 S	250	Protective rubber cap	195
Chain pipe wrench HEAVY DUTY	340	Extensions for drill bits G 1/2"	68	MAPP gas	180	Pull bending	92
Chain-spinning head	264	Extractor	110	Maxigas 400	181	<b>Q</b>	
Chain-spinning heads	267	Extractor cam pincer	111	Metal saw arch	40	Quad clamps	301
Chain-spinning heads with spikes	267	Extractor ratchet	111	MINIBEND	78	Quick clamping column	66
Chisel	358, 362	Extractor set	109	MINICUT 2000	23	<b>R</b>	
Chisel screwdriver set EUROLINE IMPAKT	348	<b>F</b>		MINICUT I PRO/II PRO	23	R 80/100 clutch jaws	259
Clamp device	301	Fitter's hammer	362	MINI MAX	24	R 550	252
Clamping set ROCUT 110	36	Fitting key	341	MLP internal bending springs	79	R 550 clutch jaws	259
Clamping set ROCUT 160	36	Fittings solders	199	MULTIBEND	77	R 600	252
Cleaning and preservation with ROCLEAN	242	Fittings wrench 90°	340	Multigas 300	181	R 600/650 clutch jaws	259
Collet for R 750	259	Fixing set concrete / masonry	66	<b>N</b>			
Copper external bending springs	79	Flame reflectors	197	Neutralization powder	246	R 600 VarioClean	253
Copper rings	67	Flanged riveted expander heads	103	NIPPLE MAX	167	R 650	254
Corner pipe wrench 45°	337	Flaring and bending set	116	Nitrogen set	314	R 750	254
		Flexible pipe welding attachments	189	<b>O</b>			
		Foam inlay for ROCASE 4212	370	One-handed corner pipe wrench 90°	339	R 750 clutch jaws	259
		Foam inlay for ROCASE 4414	370	One-handed pipe wrench ALUDUR	338	Ratchet arm for SUPER CUT	153
		Four-blade cutter	266	One-handed pipe wrench HEAVY DUTY	338	RE 17 cutting tips and heating burners	193
		Funnel auger	264, 265	One-handed pipe wrench OFFSET PATTERN HEAVY DUTY	339	RE 17 three-gas system AMS 5/5	192
		<b>G</b>				RE 17 three-gas system AMS 5/10	192
		Gas test plug / adaptor for ROTEST GW	213			RE 17 three-gas system AMS 10/10	192

# Alphabetical index

Item	Page	Item	Page	Item	Page	Item	Page
Reducer insert ROFROST TURBO 1.1/4"	221	RODIACUT 150/RODIADRILL 160	56	ROPOWER 50 R	162	Special diamond drills for tiles and natural stone	66
Reducer insert ROFROST TURBO 2"	222	RODIACUT 150/RODIADRILL 200	56	ROPOWER HANDY	250	SPEED STAR DX	64, 65
Reducing / extension pieces	272	RODIACUT 250/RODIADRILL 200	58	ROPOWER profile cable	263	Spiral baskets	261
Reduction inserts sets	285	RODIACUT 250/RODIADRILL 500	58	ROPULS eDM App	241	Spiral guide gloves	261
Reeling flaring tool	115	RODIACUT 400/RODIADRILL 500	60	ROPULS eDM Flushing compressor	240	Spiral guide hose for R 550	260
Refilling adaptor	185	RODIADRILL 160	57	ROPULS Flushing compressor	241	Spiral guide hose for R 600/650	260
Refrigerant for air-conditioning units	321	RODIADRILL 200	57, 59	ROPUMP	248	Spiral guide hose for R 750/80/100 SP/R 140 B	260
Re-Rounding clamps	302	RODIADRILL 500	59	ROPUMP SUPER PLUS	248	Spiral retrieving device	260
Retrieving auger	264, 265	RODIADRILL 1800 DRY	49	RO-QUICK	344	Spirals 6/8/10 mm	271
RO AG 8000 cordless angle grinder	356	RODIADRILL Ceramic	55	ROREC PRO	319	Spiral sawtooth cutter	264, 266
ROAIRVAC	317	RODIADUST	68	ROREC PRO A3	320	Spiral-tool set standard, 16-22 mm	270
ROAIRVAC CL	316	RODIA DW CLEANER M	69	ROSCALE 120	321	Spiral-tool set standard, 16 mm	270
ROBEND 4000	88	RODRUM L	257	ROSCOPE mini	228	Spiral-tool set standard, 22 mm	270
ROBEND 4000 / 4000 E bending sets	90	RODRUM M	257	ROSLICE	25	Spiral-tool set standard, 32 mm	270
ROBEND 4000 E	86	RODRUM M and L drums	258	ROSOLAR Pump / ROSOLAR Pump PLUS	247	Squeezing device	300
ROBEND H+W PLUS bender	80	RODRUM S	255	ROSOL soldering paste	199	S-SMK-spirals	263
ROBEND H+W PLUS bending sets	81	RODRUM VarioClean	256	ROSPI H+E Plus	249	S-spirals	263
ROBIT PRO	353	ROFAST pliers wrench	341	ROSPIMATIC CL	251	Standard bender 180°	78
ROBIT PRO torsion	353	ROFIRE 4	179	ROTEST Electronic 4	215	Standard bending plier 90°	77
ROBO MINI	40	ROFIRE 4 PIEZO	179	ROTEST GW 150/4	212	Standard spirals	263
ROBO SUPER	40	ROFIRE GLOBAL	178	ROTHERM 2000	186	Standard spirit level	350
ROBOX	369	ROFIRE SWIVEL PRO Cyclone Piezo	178	ROTORQUE AIRCON / REFRIGERATION	117	Standard expander A1	104
ROBOX pliers sets	336	ROFIRE SWIVEL PRO Twin US	178	ROTRAC 28	23	Straight auger	265
ROBOY clamping workbench	363	ROFIX adapter	161	ROTRAC 42	23	Strap and fittings wrench	342
ROBUCKET	371	RO FL 180 cordless LED lamp	359	ROVLIES cleaning pads	196	SUPER 1.1/4" and 2"	27
ROBULL type E	82	ROFLAME 4 PIEZO	178	ROWELD HE heating plates	299	SUPER CUT	150
ROBULL type ME	84	ROFLARE REVOLVER	114	ROWELD P63 S-6 Sword	296	SUPER FIRE 3	174
ROCADDY 120 R32 (CL) Analog / Digital	310	ROFROST App	221	ROWELD P110	288	SUPER FIRE 4	176
ROCAL 20 / Romatic 20	243	ROFROST CO <sub>2</sub> Set	223	ROWELD P125	298	Supergas C 200 TSS	181
ROCAL Acid Multi	246	ROFROST Freezer Heads	223	ROWELD P160 SANILINE	290	SUPERTRONIC 2 SE	165
ROCAM 4 Plus 30 meter	232	ROFROST heat conductive paste	222	ROWELD P250 A	292	SUPERTRONIC 3 SE	165
ROCAM 4 Plus 65 meter	233	ROFROST TURBO R290 1.1/4"	219	ROWELD ROFUSE Sani 160/315	295	SUPERTRONIC 4 SE	165
ROCAM camera heads	234	ROFROST TURBO R290 2"	220	ROWELD ROFUSE TURBO	294	SUPERTRONIC 1250	154
ROCAM mini HD module 25/22 HD	230	ROGRAT-MLP deburrer and chamfering tool	43	ROWELD type Premium CNC	282	SUPERTRONIC 2000	158
ROCAM mini HD module ROLOC Plus HD	231	ROGRIP F	332	ROWELD type Professional	283	SUPERTRONIC 2000 E	156
ROCAM PE-X expander power torque	99	ROGRIP M	332	ROWELD type Standard	284	Surface-heating burner heads	184
ROCASE 4407	369	ROGRIP pliers sets	336	ROWONAL care and rust remover	261	SWO adjustable wrench	345
ROCASE case system	368	ROGRIP XL	333	ROXY 400 L Set	191	<b>T</b>	
ROCASE shoulder belt with logo	370	ROGROOVER 1-6"	168	RP 30	211	Telescopic basin nut wrench	346
ROCASE Trolley	370	ROGROOVER 1-12"	169	RP 50 Digital	208	Telescopic workbench	364
ROCHECK	349	RO ID 400 cordless impact wrench	355	RP 50-S / RP 50-S INOX	209	Telescoping guide tubes	261
ROCLEAN function	242	ROKLIMA MULTI 4F	308	RP Pro III	210	Threading die head for SUPERTRONIC	160
ROCLIC	344	ROLEAK Aqua 3 Plus	214	<b>S</b>		Threading dies for SUPERTRONIC BSPT R	160
ROCLICK ratchet spanner	345	ROLEAK PRO	315	Safety foot switch	167	Threading dies for SUPERTRONIC NPT	160
ROCOOL 600	311	Rolling skids	235	Safety igniter	195	Thread interfaces	66
ROCUT 42 Twin Cut	31	ROLOCK COMBI KIT expander / extractor	108	Safety propane handles	185	Tool bag	365
ROCUT 110 set	35	ROLOCK expander power torque	98	Safety T-couplings	272	Tool bag small	366
ROCUT 160 set	35	ROLOT hard solders	201	SANIFRESH	322	Tool bag universal	366
ROCUT Plastic Pro	30	ROLUB Anti-Block special gliding shoe	81	SANIGRIP / SANIGRIP PL	341	Toolbox set	353
ROCUT TC 26	34	ROMATIC	350	SANI KIT Tool carrying case	152	Tool set Climate I and II	313
ROCUT TC 32	33	ROMAX 3000 AC	128	Sanitary four way key	343	Tool set L, 16 mm, for R 550/600/650	269
ROCUT TC 42 Professional	32	ROMAX 4000	126	Saw blades for UNI small saw PUK	40	Tool set L, 22 mm, for R 600/650/750	269
ROCUT TC 50 Professional	33	ROMAX AC ECO	129	Schrader valve tool	323	Tool set S, 16 mm, for R 550/600/650	269
ROCUT TC 63 Professional	33	ROMAX Compact III	124	SDS-plus hammer drill	67, 358	Tool set S, 22 mm, for R 600/650/750	269
ROCUT TC 75 Professional	34	RONOL	161	Separating pin	261	Torch spanner	196
ROCUT UKS 160/355	302	RONOL SYN	161	Serrated forked cutter	268		
ROCUT XL	303	ROOFING set	184	Set components for ROTEST GW	213		
RO DD 60 cordless drill driver	352			SMK-spirals	263		
				Space welding	54		
				Spade head cutter	264, 266		
				Spare extractor hook	110		

# Alphabetical index

Item	Page
Torque wrench set	117, 322, 345
TP 25	211
Trendy shoulder toolbox	366
Trendy tool bag	365
Tripod uni workbench	364
TUBE BENDER	74
TUBE BENDER MAXI	75
TUBE CUTTER 30 PRO	24
TUBE CUTTER 30 PRO INOX	26
TUBE CUTTER 35	20
TUBE CUTTER 35, DURAMAG	21
TUBE CUTTER 35 INOX, DURAMAG	21
TUBE CUTTER 35 INOX with cutting wheels	21
TUBE CUTTER 35 MSR / 42 PRO MSR / 42 PRO PVC	18, 28
TUBE CUTTER 42 PRO	22
TUBE CUTTER 42 PRO INOX	22
TUBE CUTTER 42 XL	22
TUBE CUTTER 50	24
TUBE CUTTER 67 / 125 / 168 PL Automatic	28
TUBE CUTTER CSST	26
TUBE CUTTER INOX	26
TURBOPROP brazing set	183
Two-way root cutter	264, 268
<b>U</b>	
UNICUT HM	354
UNIDRILL Automatic 28 / 42	112
UNIGRAT	42
UNI stepped key set	343
Universal flaring tool	116
Universal internal and external Deburrer	41
Universal workbench	364
<b>V</b>	
Vacuum pump RODIA-VAC	66
Vacuum sets	66
VDE screwdriver set	348
Voltage Detector E-Detector 90-1000V	351
<b>W</b>	
Wash lance	274
Water extraction systems	68
Water pump pliers SP	334
Water pump pliers SPK	335
WC-BLITZ RO 3 Toilet Cleaner	250
Welding blanket	197
Welding goggles EN 166	196
Working tool 1/8-2"	364

# Numerical index

No.	Page	No.	Page	No.	Page	No.	Page	No.	Page
<b>0</b>									
01700RD	322	015306X	140	015581X	140	070781X	151	11032	101
015060X	136	015307X	140	015582X	140	070790X	151	11035	101
015062X	136	015308X	140	015583X	140	070821X	160	11038	101
015063X	136	015311X	140	023020X	75	070822X	160	11040	101
015068X	136	015312X	140	023021X	75	070823X	160	11042	101
015080X	136	015313X	140	023022X	75	070824X	160	11044	41
015101X	139	015314X	140	023090X	75	070825X	160	11045	41
015102X	139	015315X	140	023091X	75	070826X	160	11052	101
015103X	139	015317X	140	035521-A	180, 190	070831X	160	11053	101
015104X	139	015318X	140	035521-B	180	070832X	160	11054	101
015105X	139	015321X	139	035521-C	180	070833X	160	11055	101
015106X	139	015322X	139	035648X	175, 177	070834X	160	11056	101
015151X	139	015323X	139	035780X	191	070835X	160	11057	101
015152X	139	015324X	139	045268D	196	070836X	160	11058	101
015153X	139	015325X	139	053890X	297	070840X	153	11059	101
015154X	139	015326X	139	053891X	297	070842X	160	11062	101
015155X	139	015327X	139	053892X	297	070843X	160	11063	101
015161X	139	015328X	139	053893X	297	070849X	160	11078	104
015162X	139	015329X	139	053896X	297	070850X	160	11086	104
015163X	139	015330X	139	053897X	297	070869X	160	11087	104
015164X	139	015331X	139	054230Z	295	070870X	160	11089	104
015180X	139	015333X	139	055053D	37	070891X	151	11093	104
015181X	139	015334X	139	055054D	37	070892X	151	11323	103
015182X	139	015335X	139	055074D	37	070894X	151	11325	103
015183X	139	015336X	139	056255Z	165	070901X	151	11328	103
015211X	139	015337X	139	056465Z	165	070903X	151	11332	103
015212X	139	015338X	139	057950X	82	070904X	151	11335	103
015213X	139	015339X	139	057961X	82	070905X	151	11336	103
015214X	139	015351X	140	057966X	82	070908X	160	11342	103
015215X	139	015352X	140	057969X	84	070912X	160	11346	103
015216X	139	015353X	140	057972X	84	070913X	160	11348	103
015217X	139	015354X	140	057973X	84	070914X	160	11358	103
015218X	139	015355X	140	070007D	23	070915X	160	11362	103
015219X	139	015357X	140	070007X	23	070916X	160	11364	103
015220X	139	015358X	140	070017D	23, 24, 25	070917X	160	11376	103
015222X	139	015362X	140	070027DB	21	070918X	160	11380	103
015223X	139	015364X	140	070028D	28	070919X	160	11400	102
015224X	139	015366X	140	070046D	27	070920X	160	11955	103
015225X	139	015367X	140	070051D	27	070921X	160	11958	103
015226X	139	015368X	140	070056D	22, 26	070945X	160	11962	103
015227X	139	015370X	139	070057D	25	070946X	160	11968	103
015230X	140	015371X	139	070061D	27	071533D	357	11978	103
015231X	140	015374X	139	070088D	27	071534D	357	12001	106
015232X	140	015376X	139	070089D	27	072070X	248	12005	99
015233X	140	015377X	139	070110X	337	072185F	267	12013	105
015234X	140	015378X	139	070111X	337	072945X	270	12097	106
015260X	139	015379X	139	070112X	337	072955X	270	12400	98
015261X	139	015380X	139	070121X	337	072956X	270	12408	100
015262X	139	015385X	139	070122X	337	072962X	270	12410	100
015263X	139	015389X	139	070123X	337	079890X	252	12412	100
015264X	139	015391X	139	070124X	337	088840D	25	12414	100
015265X	139	015392X	140	070130X	336	088841D	25	12415	100
015269X	139	015393H	139	070131X	337	088842D	25	12416	100
015271X	140	015393X	139	070132X	337	<b>1</b>		12418	100
015277X	140	015394X	140	070134X	337	11004	102	12420	100
015280X	140	015395X	139	070135X	336	11006	41	12422	100
015281X	140	015396X	140	070137X	336	11007	103, 106	12428	100
015282X	140	015397X	140	070140X	336	11008	101	12432	100
015283X	140	015398X	139	070188D	28	11010	101	12435	100
015284X	140	015399X	139	070401C	23	11012	101	12438	100
015291X	140	015401X	134, 139	070522D	335	11014	101	12440	100
015292X	140	015530X	140	070523E	335	11015	101	12442	100
015293X	140	015531X	140	070690X	364	11016	101	12452	100
015294X	140	015532X	140	070699X	364	11018	101	12453	100
015302X	140	015533X	140	070705X	363	11020	101	12454	100
015304X	140	015534X	140	070735X	363	11022	101	12455	100
		015580X	140	070780X	151	11028	101	12456	100

# Numerical index

No.	Page	No.	Page	No.	Page	No.	Page	No.	Page
12457	100	15750	129	100000230	114	1000001308	255	1000001895	132
12458	100	15760	129	100000231	114	1000001391	138, 139	1000001896	132
12459	100	19166	367	100000235	139	1000001392	138, 139	1000001923	127
12462	100	19207	243	100000236	139	1000001393	138, 139	1000001924	127
12463	100	100108	346	100000328	333	1000001394	138, 139	1000001925	127
12500	99	100109	346	100000383	283	1000001425	367	1000001926	127
12503	99	100110	346	100000385	285	1000001426	312	1000001927	127
12505	99	100112	346	100000442	215	1000001427	312	1000001932	127
12509	99	100113	346	100000445	77	1000001431	77	1000001938	232
12511	99	100114	346	100000529	190	1000001500	138	1000001955	371
12517	99	111405	358	100000532	302	1000001501	138	1000001959	129
12518	99	111406	358	100000539	311	1000001502	137	1000001989	130, 132
12521	99	111411	358	100000540	311	1000001545	89	1000002002	21
12522	99	111413	358	100000541	311	1000001549	89	1000002011	159
12524	99	111418	358	100000550	285	1000001550	89	1000002012	369
12526	99	111419	358	100000558	190	1000001551	89	1000002035	352
12535	99	111424	358	100000560	282	1000001552	89	1000002036	355
12536	99	111426	358	100000561	282	1000001553	89	1000002037	356
12537	99	111427	358	100000563	282	1000001554	89	1000002065	136
12538	99	111429	67, 358	100000565	282	1000001559	89	1000002067	136
12541	99	111432	358	100000567	282	1000001561	90	1000002068	136
12601	108	111439	358	100000569	311	1000001563	90	1000002069	136
12602	108	111440	358	100000570	311	1000001565	89	1000002077	26
12604	108	111445	358	100000572	311	1000001566	89	1000002108	369
12605	108	111447	358	100000620	190	1000001567	89	1000002109	369
13002	105	111450	67, 358	100000629	190	1000001630	177	1000002134	135
13100	105	111452	358	100000633	195	1000001647	352	1000002135	135
14000	43	111454	358	100000642	190	1000001648	355	1000002136	135
14122	43	111455	358	100000720	168	1000001649	356	1000002180	353
14126	43	168605	319	100000721	168	1000001651	359	1000002181	353
14250	43	168713	319, 320	100000722	168	1000001652	39, 125, 361	1000002182	353
14708	139	169200	318	100000723	168	1000001653	39, 125, 361	1000002189	336
14822	139	170016	322	100000743	190	1000001654	39, 125, 361	1000002207	130, 132
14823	139	170501	312	100000762	195	1000001711	257	1000002222	21
14824	139	170502	312	100000764	195	1000001712	257	1000002266	134, 139
14825	139	170545	312	100000820	283	1000001713	257	1000002267	134, 139
14826	139	170546	312	100000823	283	1000001714	257	1000002268	228
14832	140	170547	312	100000824	283	1000001727	258	1000002298	251
14833	140	170600	312	100000825	283	1000001728	258	1000002299	251
14834	140	170601	312	100000850	168	1000001729	258	1000002358	178
14835	140	170602	312	100000863	283	1000001730	258	1000002359	179
14836	140	170604	313	100000864	283	1000001731	258	1000002360	179
14837	140	170605	313	100000865	283	1000001732	258	1000002364	177
14838	140	170606	312	100000884	282	1000001734	359	1000002366	177
14843	139	170607	312	100000885	282	1000001738	89	1000002368	177
14844	139	170608	312	100000886	282	1000001745	367	1000002369	175
14845	139	170901	322	100000935	285	1000001747	26	1000002370	175
14846	139	170912	321	100000936	285	1000001748	22	1000002371	175
14847	139	170932	321	100000997	283	1000001749	132	1000002399	318
14848	139	170950	322	100000999	294	1000001750	132	1000002481	233
14849	135	170960	321	1000001000	294	1000001751	132	1000002548	39, 361, 125
14852	140	170961	321	1000001001	128	1000001752	132	1000002549	39, 361, 125
14853	140	173204	322	1000001068	336	1000001753	132	1000002560	310
14854	140	173205	322	1000001080	283	1000001754	132	1000002561	310
14855	140	175001	117, 322, 345	1000001081	282	1000001755	132	1000002625	369
14863	139	1000000046	23	1000001082	282	1000001756	132	1000002627	371
14865	139	1000000124	139	1000001126	138	1000001762	248	1000002628	370
14868	139	1000000125	139	1000001134	240	1000001810	137, 139	1000002630	295
14869	135	1000000138	309	1000001231	318	1000001811	137, 139	1000002631	295
14882	140	1000000145	241	1000001245	297	1000001836	235	1000002683	127
14883	140	1000000173	139	1000001256	255	1000001840	127	1000002697	332
14884	140	1000000190	241	1000001257	255	1000001889	132	1000002698	332
14885	140	1000000212	168	1000001270	297	1000001890	132	1000002699	332
14886	140	1000000222	114	1000001273	137, 139	1000001891	132	1000002700	332
14895	135	1000000223	114	1000001274	137, 139	1000001892	132	1000002701	332
15730	129	1000000224	117	1000001275	255	1000001893	132	1000002702	332
15740	129	1000000225	117	1000001276	255	1000001894	132	1000002704	332



# Numerical index

No.	Page	No.	Page	No.	Page	No.	Page	No.	Page
1000002705	332	1000003874	133	1000004215	163	1500000439	261	1500002869	178
1000002713	318	1000003876	133	1000004261	125	1500000789	303	1500002876	213
1000002714	318	1000003877	133	1000004263	125	1500000792	303	1500002892	233
1000002800	134	1000003878	133	1000004265	125	1500000793	303	1500002921	179
1000002801	134	1000003879	133	1000004266	125	1500000795	303	1500002922	179
1000002803	134	1000003880	133	1000004267	125	1500000817	235	1500003163	351
1000002804	134	1000003881	133	1000004269	125	1500000914	246	1500003164	351
1000002823	248	1000003882	133	1000004271	125	1500001235	247	1500003166	351
1000002945	130	1000003883	133	1000004272	125	1500001236	247	1500003167	351
1000002946	130	1000003884	133	1000004273	125	1500001299	365	1500003168	351
1000003011	31	1000003885	133	1000004274	125	1500001320	365	1500003169	351
1000003051	30	1000003920	230	1000004275	125	1500001324	250	1500003296	233
1000003052	30	1000003921	230	1000004276	125	1500001351	169	1500003374	351
1000003104	31, 34	1000003922	230	1000004277	125	1500001352	169	1500003381	322
1000003106	30	1000003930	133	1000004278	125	1500001353	169	1500003517	241
1000003165	39	1000003931	133	1000004279	125	1500001355	177	1500003533	214
1000003199	215	1000003933	133	1000004280	125	1500001503	177	1500003535	214
1000003229	316	1000003934	133	1000004281	125	1500001509	345	1500003621	39
1000003230	316	1000003938	133	1000004283	125	1500001510	345	1500003673	39
1000003231	316	1000003939	133	1000004284	125	1500001547	350	1500003674	39
1000003233	316	1000003940	133	1000004285	125	1500001548	350	1500003693	39
1000003345	253	1000003941	133	1000004286	125	1500001583	350	1500003694	39
1000003346	253	1000003960	230	1000004287	125	1500001736	345	1500003703	263, 271
1000003347	256	1000003962	231	1000004288	125	1500002182	366	1500003704	263, 271
1000003348	256	1000003963	231	1000004289	125	1500002230	366	1500003705	271
1000003371	256	1000003964	231	1000004292	125	1500002239	370	1500003706	256, 271
1000003372	253	1000003965	230	1000004293	125	1500002241	315	1500003707	256, 271
1000003374	39	1000003973	133	1000004332	125	1500002253	258	1500003708	256, 271
1000003387	157	1000003974	133	1000004333	125	1500002254	258	1500003965	287
1000003388	157	1000003975	133	1000004403	294	1500002255	258	1500004021	165
1000003389	157	1000003976	133	1000004423	125	1500002256	258	1500004023	165
1000003390	341	1000003978	69	1000004424	125	1500002257	258	1500004026	165
1000003391	87	1000004000	208	1200000526	302	1500002258	258	1500004028	165
1000003392	87	1000004125	230	1300003334	368	1500002259	258	1500004038	287
1000003393	87	1000004126	230	1300003336	368	1500002260	258	1500004051	51
1000003394	87	1000004127	230	1300003337	368	1500002261	258	1500004054	51
1000003398	39	1000004128	230	1300003338	368	1500002262	258	1500004055	51
1000003580	130, 132	1000004131	230	1300003541	368	1500002263	258	1500004056	51
1000003581	130, 132	1000004132	231	1300003542	81	1500002264	258	1500004057	51
1000003589	133	1000004133	231	1300003649	368	1500002265	258	1500004058	51
1000003590	133	1000004137	231	1300005506	368	1500002266	258	1500004059	51
1000003610	133	1000004138	253	1300007335	187	1500002267	258	1500004060	51
1000003611	133	1000004139	253	1500000024	313	1500002268	258	1500004061	51
1000003612	133	1000004143	256	1500000025	313	1500002271	258	1500004062	51
1000003613	133	1000004144	256	1500000026	313	1500002449	370	1500004063	51
1000003614	133	1000004145	256	1500000027	313	1500002450	370	1500004064	51
1000003615	133	1000004165	127	1500000028	313	1500002453	353	1500004065	51
1000003616	133	1000004166	127	1500000029	313	1500002454	353	1500004066	51
1000003617	133	1000004167	127	1500000030	313	1500002598	295	1500004067	51
1000003622	310	1000004169	127	1500000031	313	1500002613	232	1500004068	51
1000003623	310	1000004170	127	1500000032	313	1500002614	232	1500004069	51
1000003641	133	1000004173	127	1500000087	365	1500002615	233	1500004070	51
1000003642	284	1000004174	127	1500000115	246	1500002616	233	1500004071	51
1000003643	284	1000004180	316	1500000116	246	1500002641	369	1500004072	51
1000003644	284	1000004181	316	1500000117	246	1500002763	369	1500004074	52
1000003645	284	1000004182	316	1500000120	235	1500002779	369	1500004075	52
1000003646	284	1000004183	316	1500000122	234	1500002824	358	1500004076	52
1000003647	284	1000004184	157	1500000123	234	1500002825	358	1500004077	52
1000003648	284	1000004185	157	1500000135	247	1500002826	358	1500004078	52
1000003703	133	1000004186	157	1500000136	247	1500002827	358	1500004080	52
1000003858	125, 360	1000004190	87	1500000157	242	1500002828	358	1500004081	52
1000003859	125, 360	1000004191	87	1500000200	242	1500002829	358	1500004082	52
1000003860	125, 360	1000004192	87	1500000201	242	1500002845	213	1500004083	52
1000003863	125, 360	1000004193	87	1500000202	242	1500002846	213	1500004084	52
1000003864	125, 360	1000004212	163	1500000203	241	1500002847	213	1500004085	52
1000003865	314	1000004213	163	1500000236	41	1500002848	213	1500004086	52
1000003872	133	1000004214	163	1500000237	41	1500002851	213	1500004087	52

# Numerical index

No.	Page	No.	Page	No.	Page	No.	Page	No.	Page
1500004088	52	22038	110	24501	81	25628	90	31091	182
1500004089	52	22042	110	24502	81	25652	90	31092	182
1500004090	52	22050	110	24504	81	25684	90	31094	183
1500004091	52	22054	110	24505	81	25685	90	32077	195
1500004092	52	22060	110	24508	80	26001	113	32081	185
1500004093	52	22061	110	24510	80	26002	113	32088	195
1500004094	52	22062	110	24512	80	26003	113	32201	185
1500004095	52	22063	110	24514	80	26004	113	32207	185
1500004096	52	22064	110	24515	80	26005	113	32223	185
1500004097	52	22065	110	24516	80	26010	113	33079	185
1500004098	52	22066	110	24518	80	26011	113	33310	185
1500004099	52	22068	110	24519	80	26013	113	33311	194
1500004100	51	22080	111	24522	80	26015	113	35012	178
1500004163	53	22100	109	24552	80	26016	113	35016	178
1500004165	53	22103	109	25075	81	26017	113	35178	194
1500004167	53	22109	109	25076	81	26020	116	35179	194
1500004168	53	22111	109	25078	81	27180	111, 343	35188	194
1500004170	53	22121	109	25120	79, 81	27181	111	35189	194
1500004171	53	22124	109	25130	78	222401	115	35199	195
1500004172	53	22126	109	25131	78	222402	115	35210	194
1500004173	53	22127	109	25132	78	222403	115	35221	194
1500004174	53	22135	109	25133	78	222412	115	35222	194
1500004175	53	22214	110	25134	78	222413	115	35223	194
1500004176	53	22242	110	25135	78	222601	116	35300	188
1500004177	53	22246	110	25136	78	224500	323	35303	188
1500004179	53	22254	110	25137	78	252100	350	35304	188
1500004180	53	22260	110	25140	78	255040	350	35305	188, 189
1500004181	53	22263	110	25142	78	255060	350	35306	188, 189
1500004182	53	22264	110	25150	78	259008	314	35307	188, 189
1500004183	53	22265	110	25151	78	259018	314	35308	188, 189
1500004184	53	22266	110	25181	79	211111116	185	35309	188, 189
1500004185	53	22267	110	25182	79	211121116	185	35312	188, 189
1500004186	53	22270	110	25183	79	221031500	183	35313	188, 189
1500004187	53	23001	75	25185	79	221031800	183	35314	188, 189
1500004195	219	23002	75	25186	79	221131416	182	35315	188, 189
1500004196	220	23003	75, 76	25190	79	221131616	182	35324	193
1500004290	245	23004	75	25308	81	221131916	182	35325	193
1500004322	245	23005	75, 76	25310	81	221132216	182	35326	193
1500004325	245	23006	75	25312	81	223090716	184	35327	193
1500004345	287	23007	75	25313	81	223090916	184	35328	193
1500004346	300	23008	75	25314	81	223214500	184	35329	193
1500004347	300	23009	76	25315	81	223215100	184	35334	193
1500004348	300	23010	75	25316	81	223215700	184	35338	193
1500004349	300	23011	75	25318	81	223216300	184	35339	193
1500004350	245	23012	75	25319	81	231010000	184	35341	193
1500004451	320	23013	75	25322	81	232010000	184	35344	193
1500004454	349	23047	75	25401	77	233510000	184	35345	193
<b>2</b>		23050	76	25402	77	236010000	184	35347	193
21300	354	23051	76	25403	77	242206000	185	35348	193
21316	354	23052	75, 76	25404	77	263005400	191	35354	194
21319	354	23053	76	25405	77	263005600	191	35400	192
21334	354	23065	76	25406	77	263005800	191	35401	192
21335	354	23076	76	25441	79	<b>3</b>		35403	192
21395	354	23080	76	25442	79	30102	185	35431	175
21575	112	23083	76	25443	79	30913	182	35436	175
21583	112	23095	76	25445	79	30914	182	35475	193
21652	25	24001	74	25446	79	30915	182	35476	193
21655	42	24006	74	25612	90	30916	182	35477	193
21660	42	24007	74	25614	90	30925	185	35479	193
22010	110	24008	74	25615	90	30927	185	35480	193
22012	110	24048	74	25616	90	30954	184	35580	191
22015	110	24049	74	25618	90	30957	184	35585	191
22016	110	24131	74	25619	90	31032	183	35611	200
22018	110	24132	74	25620	90	31042	197	35629	189
22022	110	24133	74	25622	90	31043	197	35634	195
22028	110	24134	74	25625	90	31050	197	35635	194
22035	110	24500	81	25626	90	31090	183	35636	185

# Numerical index

No.	Page	No.	Page	No.	Page	No.	Page	No.	Page
35651	191	45268	196	54084	291	55322	298	56505	168
35655	189	402308	366	54085	291	55324	289	56506	168
35695	191	402311	365	54086	291	55391	283	56507	168
35696	191	402312	366	54087	291	55505	302	56508	168
35697	191	462212	77	54088	291	55517	299	56509	168
35698	190	462215	77	54089	291	55518	299	56521	168
35712	191	462218	77	54090	291	55524	289	56522	168
35713	191	462222	77	54091	291	55536	298	56523	168
35750	190, 194	490050016	116	54190	283	55539	298	57981	83, 85
35782	191	<b>5</b>		54274	283	55546	298	57983	83, 85
35785	191	52000	32	54950	37	55585	298	57985	83, 85
35794	195	52005	34	54960	37	55587	298	57986	83, 85
35800	193	52010	33	54961	37	55588	298	57987	83, 85
36700	187	52011	34	55005	34	55589	298	57988	83, 85
36702	187	52015	34	55006	34	55590	298	57989	83, 85
300013	40	52016	34	55015	34	55591	298	57990	83, 85
321216	289	52030	33	55019	37	55592	298	57991	83, 85
321218	289	52031	34	55020	36	55593	298	58010	83, 85
322823	362	52040	33	55021	36	55594	298	58011	83, 85
322922	362	52041	34	55022	36	55596	298	58012	83, 85
323126	348	52042	34	55023	36	55597	298	58013	83, 85
350850	341	53200	300	55024	36	55598	298	58014	83, 85
350900	341	53210	300	55025	36	55684	291	58015	83, 85
351043	343	53220	300	55026	36	55685	291	58016	83, 85
351044	343	53251	301	55027	36	55718	293	58182	83, 85, 260
351050	346	53252	301	55029	37	55719	293	58185	83, 85
351220	213	53253	301	55030	36	55721	293	510105	196
351221	213	53254	301	55031	36	55738	293	510106	196
351222	213	53255	301	55032	36	55742	293	511427	195
351223	213	53256	301	55033	36	55743	293	511428	195
351225	213	53258	301	55035	35	55744	293	540360	195
351226	213	53259	301	55047	36	55745	293	540365	195
351227	213	53260	301	55048	36	55746	293	540620	196
351228	213	53261	301	55050	303	55747	293	540621	196
351231	213	53262	301	55051	303	55748	293	540622	196
351232	213	53263	301	55058	303	55749	293	540625	196
351233	213	53271	301	55063	35	55750	293	540626	196
351257	213	53272	301	55075	342	55751	293	540627	196
351260	213	53273	301	55076	342	55752	293	540640	196
351261	213	53274	301	55119	289	55753	293	540641	196
351262	213	53275	301	55120	289	55768	293	540675	196
351263	213	53276	301	55121	289	55787	289	540851	196
351265	213	53277	301	55122	289	55795	293	540855	196
351271	213	53278	301	55123	289	55807	289	561351	197
351272	213	53279	301	55124	289	55808	289	<b>6</b>	
<b>4</b>		53280	301	55125	289	55809	289	60200	209
40005	202	53281	302	55126	289	55826	289	60201	209
40015	203	53282	302	55127	289	55832	289	60203	209
40094	201	53283	302	55128	289	55844	289	60250	211
40202	201	53284	302	55129	289	55851	299	60251	211
40212	202	53285	302	55130	289	55854	299	60999	209
40213	202	53355	283	55131	289	56047	167	61011	213
40500	200	53415	283	55132	289	56051	163	61014	213
40502	202	53425	283	55133	289	56056	167	61017	213
40514	200	53511	297	55134	289	56060	167	61018	213
40528	200	53512	297	55152	289	56061	167	61030	213
44915	203	53513	297	55199	289	56064	167	61041	213
44916	203	53514	297	55232	285	56250	165	61100	243
44917	203	53515	297	55234	285	56253	165	61105	246
45055	203	53516	297	55237	285	56255	165	61106	246
45056	203	54004	291	55240	285	56335	167	61115	246
45220	199	54005	291	55241	285	56465	165	61120	246
45225	199	54040	291	55316	299	56466	165	61130	211
45250	199	54058	294	55317	299	56475	165	61185	210
45252	199	54080	291	55318	289	56500	167	61186	210
45255	199	54082	291	55319	289	56501	167	61190	243
45257	199	54083	291	55321	298	56504	168	61316	209

# Numerical index

No.	Page	No.	Page	No.	Page	No.	Page	No.	Page
61700	212	70080	23	70265	340	70713	363	72186	267
61701	212	70086	27	70266	340	70714	363	72187	267
61702	213	70087	27	70267	340	70715	363	72188	267
62211	221	70105	23	70269	342	70740	364	72191	268
62212	221	70108	28	70285	26	70751	364	72193	268
62213	221	70109	28	70286	26	70752	364	72203	265
62214	221	70113	337	70289	167	71019	24	72208	265
62215	221	70114	337	70340	26	71085	26	72210	272
62216	221	70115	339	70341	26	71206	40	72211	272
62217	221	70116	339	70350	338	71213	40	72221	265
62219	221	70125	337	70351	338	71216	40	72222	265
62221	221	70142	25	70352	338	71217	40	72223	268
62224	221	70148	338	70353	338	71250	159	72224	268
62226	221	70150	338	70354	338	71251	159	72226	268
62227	221	70151	338	70355	338	71256	159	72227	268
62230	221	70152	338	70356	338	71257	159	72228	268
62231	222	70153	338	70374	338	71258	159	72229	266
62232	222	70154	338	70375	338	71259	159	72234	266
62233	222	70155	338	70376	338	71271	161	72250	268
62234	222	70156	338	70377	338	71450	155	72251	268
62235	222	70157	338	70378	338	71453	155	72261	266
62236	222	70158	338	70379	338	71454	155	72263	265
62237	222	70159	338	70380	338	71470	155	72264	265
62291	222	70160	338	70401	23	71975	250	72265	268
65000	215	70161	338	70402	23	71976	250	72266	268
65008	161	70162	338	70412	344	71991	248	72275	266
65010	161	70163	338	70413	344	72003	250	72276	266
65011	161	70166	339	70414	344	72005	249	72277	266
65013	161	70167	339	70415	341	72016	255	72278	267
65015	161	70168	338	70416	341	72071	248	72284	267
65030	223	70169	338	70418	345	72072	248	72285	267
65035	223	70189	338	70419	345	72073	248	72286	267
65036	223	70190	338	70420	345	72090	249	72289	267
65037	223	70191	338, 339	70421	345	72095	249	72295	268
65038	223	70192	338, 339	70422	345	72100	261	72299	267
65039	223	70193	338	70423	345	72101	261	72321	265
65040	223	70194	338, 339	70424	345	72102	261	72322	265
65041	223	70195	338	70426	345	72110	261	72324	268
65042	223	70196	338	70427	345	72111	261	72325	265
69111	235	70197	338	70439	344	72112	261	72326	268
69112	235	70198	338	70490	344, 345	72120	261	72327	268
69113	235	70199	338	70520	334	72121	261	72328	268
69117	235	70200	338	70521	335	72130	261	72329	266
69118	235	70201	338, 339	70522	335	72135	260	72341	267
69119	235	70202	338	70523	335	72140	261	72348	267
<b>7</b>		70203	338, 339	70527	334	72142	261	72350	268
70006	24	70204	338, 339	70528	334	72150	272	72351	268
70010	23	70205	338	70529	334	72151	272	72360	266
70011	23	70206	338	70545	340	72154	266	72363	265
70015	24	70207	338	70571	340	72158	265	72365	268
70027	21	70208	338	70572	340	72159	265	72366	268
70029	22	70225	346	70573	340	72161	265	72412	271
70030	25	70226	346	70574	340	72162	265	72413	251, 271
70031	28	70227	346	70575	340	72163	265	72415	271
70032	28	70228	346	70591	335	72164	266	72420	271
70033	28	70235	339	70592	335	72165	265	72421	271
70040	27	70240	342	70593	335	72166	266	72422	271
70041	23, 24, 26	70241	342	70600	152	72168	268	72423	271
70042	25	70242	340	70623	365	72169	266	72424	271
70045	27	70243	340	70661	349	72170	266	72425	251
70053	27	70244	340	70667	349	72171	266	72428	263
70055	21	70245	340	70696	364	72172	268	72431	263
70060	27	70246	340	70698	364	72175	266	72433	263
70064	27	70247	340	70700	363	72176	266	72435	263
70065	24	70262	340	70710	363	72177	266	72441	263
70070	22	70263	340	70711	363	72178	266	72442	263
70072	28	70264	340	70712	363	72185	267	72443	263

# Numerical index

No.	Page	No.	Page	No.	Page	No.	Page
72444	263	87800	323	FF34160	56	FF44810	61
72451	263	88812	25	FF34200	58	FF44812	61
72452	263	88815	25	FF34260	58	FF44814	61
72453	263	88818	25	FF34500	60	FF44815	61, 66
72455	263	88822	25	FF35015	66	FF44816	61
72460	272	88832	25	FF35028	67	FF44820	61, 66
72461	272	89501	322	FF35040	68	FF44822	62
72463	272	89503	322	FF35045	68	FF44824	62
72490	263	854179	197	FF35050	68	FF44830	62
72494	250	854181	197	FF35055	68	FF44835	62
72514	259	854182	197	FF35060	68	FF44840	62
72515	259	854183	197	FF35065	68	FF44850	62
72522	271	854184	197	FF35070	68	FF44855	62
72536	259	854185	197	FF35075	68	FF44860	62
72538	259	854186	197	FF35080	66	FF44867	62
72540	260	854187	197	FF35095	66	<b>R</b>	
72541	260	854188	197	FF35120	66	R17300416	321
72559	260	854390	349	FF35121	66	R2403200	74
72561	259	856907	365	FF35190	67	R2403300	74
72562	259	865008700	155	FF35200	66	R2403400	74
72563	259	887307000	168	FF35301	67	R2403500	74
72638	259	887308000	168	FF35302	67	R6112500	209
72666	259	887309000	168	FF35700	68	R17300416	321
72680	254	<b>9</b>		FF35710	66	<b>V</b>	
72686	252	996277400	83, 85	FF35730	68	V12102000	210
72687	252	<b>F</b>		FF35740	66		
72688	254	FF00025	65	FF40056	68		
72689	254	FF00030	65	FF40150	55		
72820	274	FF00045	65	FF40165	56, 57		
72869	252	FF00050	65	FF40185	49		
72910	254	FF00055	65	FF40220	56, 57, 58, 59		
72915	259	FF00065	65	FF40400	58, 59, 60		
72918	258	FF00075	65	FF44030	63		
72936	269	FF00100	65	FF44040	63		
72937	269	FF00110	65	FF44050	63		
72938	269	FF00120	65	FF44060	63		
72939	269	FF00130	65	FF44070	63		
72942	251	FF00140	65	FF44080	63		
73280	343	FF00150	65	FF44090	63		
73297	343	FF00160	65	FF44100	63		
73298	343	FF00200	65	FF44110	63		
73570	347	FF00250	65	FF44120	63		
73571	347	FF00280	65	FF44125	63		
73575	348	FF00300	65	FF44130	63		
76020	273	FF00350	65	FF44140	63		
76065	275	FF00500	65	FF44150	63		
76067	275	FF00610	64	FF44160	63		
76068	274	FF00612	64	FF44170	63		
76070	273	FF00616	64	FF44180	63		
76088	275	FF00618	64	FF44200	63		
76089	275	FF00620	64	FF44220	63		
77050	362	FF00625	64	FF44250	63		
77397	350	FF00632	64	FF44300	63		
77506	275	FF00640	64	FF44620	63		
78551	250	FF00645	64	FF44630	63		
701011500	27	FF00650	64	FF44640	63		
750004100	25	FF00655	64	FF44650	63		
762955300	90	FF00665	65	FF44660	63		
762955700	90	FF00675	65	FF44670	63		
766004016	74	FF00680	65	FF44680	63		
766100016	75	FF00700	65	FF44690	63		
767050016	77	FF00710	65	FF44700	63		
767750016	77	FF00730	65	FF44710	63		
775004000	83, 85	FF30030	60	FF44720	63		
775504100	83, 85	FF30150	56	FF44730	63		
<b>8</b>		FF30250	58	FF44806	61		
85800	322	FF34150	56	FF44808	61		

# Abbreviations

Abbreviation	Description
A/S	Acetylene/Oxygen
ABS	Acrylonitrile Butadiene Styrene
ADR	Agreement concerning the International Carriage of Dangerous Goods by Road
Ag	Silver
Al	Aluminium
AMS	Acetylen-Maxigas-Oxygen
AS	Anti-slip
B	Gasoline
BGV	Professional association regulations
BSP	British Standard Pipe
BSPP	British Standard Pipe Parallel thread
BSPT	British Standard Pipe Taper thread
BSR	Band saw pipe
BSW	British Standard Whitworth
BTU	British Thermal Unit
CE	European conformity
CEN	European Committee for Standardization
CFC	Chlorofluorocarbon
CFM	Cubic feet per minute
CFT	Constant Force Technology
CL	Channel lock
CNC	Computer numerical control
Cu	Copper
DK	Pressure class
DN	Nominal diameter
DVGW	German Technical and Scientific Association for Gas and Water
DVS	German Welding Society
EAN	European Article Number
EPT	Enclosed Power Transmission
Fe	Iron
FS	Guide hose
G	Cylindrical threads according to ISO 228-1
GW	Gas/Water
HCFC	Hydrochlorofluorocarbon
HD	High pressure
HFC	Hydrofluorocarbon
HM	Hard metal
HR	Hardness according to Rockwell
HSS	High-speed steel
Hz	Hertz
IP	Protection class against water and dust
ISO	International Organization for Standardization
kcal	Kilocalorie
KSO	Capillary gap optimization
L	Large
LCD	Liquid-crystal display
LED	Light-emitting diode
MIM	Metal injection molding
MPa	Megapascal
Ms	Brass
MLP	Multilayer composite pipe
Nm	Newton meter
NPT	American National Standard Taper Pipe Thread
PB	Polybutylene
PD	Power Driver
PD-E	Power Drive-Electronic
PE	Polyethylene
PEX	Cross-linked polyethylene
PL	Plastic
PP	Polypropylene
PS	Professional
PSI	Pound per square inch
PVC	Polyvinyl chloride
PVDF	Polyvinylidene fluoride
RC	Rodiacut
SAE	Society of Automotive Engineers

Abbreviation	Description
SD-Card	Secure digital memory card
SDR	Standard dimension ratio
SMK	Spiral with plastic core
SML	Super metallite delivery program
SP	Standard plier
SP	Special performance
SPK	Standard plastic plier
SS	Quick cut
SW	Spanner size
TC	Tube cutter
TFT	Thin-film transistor
TiN	Titanium nitride
TPI	Bits per inch
TRGI	Technical rule for gas installation
TRWI	Technical rules for drinking water installation
TÜV	Technical Inspection Association
UKS	Orbital circular saw
UNC	Unified coarse threads
UNF	Unified fine threads
USB	Universal Serial Bus
VA steel	Corrosion resistant steel
VDE	Association for Electrical, Electronic and Information Technologies
PU	Packaging unit
WG	Hot gas
Zn	Zinc
ZPZ	Bits per inch
ZVSHK	Central Association for Sanitation, Heating and Air Conditioning

# Pictograms

AC 230V	AC 115V	AC 110V	Three-phase current 400V	Battery-powered	Can be used in confined spaces
Suitable for tight spaces	Light and compact	Basic soft soldering up to 450 °C	Hot brazing 450–1,100 °C	Max autogen welding 1,100 °C	Fast cut
No deformation from use	Dry drilling	Wet drilling	Up to 50% time-saving 50 %	Portable operation	360° rotatable
Ergonomic design	Meets DIN standards	Propane control	Oxygen control	Acetylene control	Shock absorption
Inspection window	Pressure hose length 1,5 m	Lock button	Bayonet coupling	Push lock	Thread lock
Pressure gauge display adjustable	Pressure gauge classe 1–6 class 1.6	Pressure gauge size 80 mm	Counter display	Measuring accuracy up to Xg 10 g	Scale range up to Xkg max. 100 kg
Economy valve	With USB connection	Touchscreen	WiFi	Piezo ignition	Fine adjustment of the flame
With video function	With photo function	Memory card	Cable length 30 m	Sturdy casing	Pressure hose ball valve
Transport case	ROCASE case system	RO SERVICE+ warranty services	Electric motor without carbon brushes	DURA LAZR TEC laser hardening process	Constant Force Technology
Eco-friendly refrigerant	eTOOL (NFC tag)	One-handed operation	180° rotatable	App for Android and iOS	

# General conditions for the sale of Goods

## § 1 Scope

1. These General Terms and Conditions of Sale apply to all business relationships between ROTHENBERGER Werkzeuge GmbH, Industriestr. 7, 65779 Kelkheim, Germany ("we" or "us") with our customers ("Buyer" or "Purchaser"). The General Terms and Conditions of Sale (GTCs) shall only apply if the Buyer is a company, an entrepreneur, a legal person under public law or federal special funds (B2B business).

2. The GTCs apply, in particular, to contracts on the sale and/or delivery of movable items ("Goods") without consideration given to whether we manufacture the Goods or purchase these from suppliers (§§ 433, 651 BGB). Unless otherwise agreed, the GTCs in the version valid at the time of the Buyer's order or in any case in the version last notified to him in text form shall also apply as a framework agreement for similar future contracts, without us having to refer to them again in each individual case.

3. Our GTCs apply exclusively. Deviating, conflicting or supplementary general terms and conditions of the Buyer shall only become an integral part of the contract if and insofar as we have expressly agreed in writing to the validity of such conditions. In particular, no consent can be seen in the acceptance of the subject matter of the contract or the payment, even if the acceptance or payment is made with knowledge of conflicting or supplementary general terms and conditions of the Buyer. Similarly, any previously agreed general terms and conditions of the Buyer that conflict with or supplement these GTCs shall no longer be recognized.

4. Individual agreements entered into with the Buyer in individual cases (including subsidiary agreements, supplementary information and amendments) shall have preference over these GTCs. Subject to proof to the contrary, a written contract or our written confirmation shall be decisive for the content of such agreements.

## § 2 Conclusion of contract

1. All offers are subject to change without notice. Catalogue and leaflet details are only approximate. Constructive changes are reserved. Technical documentation (e.g. drawings, plans, calculations, references to DIN standards) are not binding for us unless otherwise agreed in writing.

2. The Buyer shall be bound by his pending order for 4 weeks after receipt by us. The contract of purchase shall be deemed entered into if the order has been accepted in text form within this period or the delivery has been performed.

3. Supplementary information, amendments and subsidiary agreements are subject to written confirmation by us.

## § 3 Prices and terms of payment

1. Unless otherwise agreed or stated, the prices apply EXW (INCOTERMS 2020), based on our respective location, excluding packaging, freight, postage, customs duties, surcharges and insurance etc. plus VAT. These costs shall be charged separately.

2. Insofar as the agreed prices are based on our list prices and the delivery takes place more than 2 months after conclusion of the contract, the list prices valid at the time of delivery shall apply.

3. For orders that do not exceed an order value of 250.00 € net, we charge a minimum quantity surcharge of 15.00 €.

4. For orders that are sent to an address that differs from the Buyer's address (so-called drop shipment), we charge a surcharge of 5.00 €.

5. Unless advance payment has been agreed, the payment of deliveries within the EU, EFTA and UK must be made within 30 days of the invoice date without deduction to one of our named accounts.

6. Payment for deliveries outside the EU, EFTA and UK shall be made exclusively by advance payment.

7. In the event of default in payment on the part of the Buyer, we shall at least be entitled to the statutory default interest. This does not affect additional claims for default, for example against merchants in respect of the commercial interest after the due date (§ 353 HGB), remain unaffected.

8. Except in cases of a fixed price agreement, the parties undertake, at the request of a party, to agree, based on good faith principles, on an appropriate price correction if, in the case of a contract with term of at least 12 months, at least three months after entering

into the contract order-related costs increase or drop for us, in a manner that is verifiable and significant (more than 5%) for reasons that are not our responsibility, e.g. as a result of increased raw material prices or energy costs.

9. In the event of default in payment on the part of the Buyer or in the case of reasonable doubt about the Buyer's creditworthiness (including facts that already applied at the time of entering into the contract) and which we were not aware of (or which we should have been aware of), we shall be entitled, prior to further performing the contract, to request advance payment for outstanding services or request the provision of security. Following the lapse in vain of a reasonable additional period for providing such securities, we shall be entitled (irrespective of further statutory rights) to withdraw from the contract.

10. Where the Buyer has authorized us to use SEPA direct debiting, such a direct transfer order collection shall normally be announced in advance in conjunction with the invoicing at the latest 1 (one) calendar day prior to the due date of the direct debit (pre-notification).

## § 4 Setting off, right of retention

The Buyer may only have the right to offset if his counterclaims have become *res judicata*, are not disputed or have been recognized by us. The Buyer shall only be entitled to exercise a right of retention insofar as his counterclaim is based on the same contractual relationship.

## § 5 Scope of delivery, deviation from the order, procurement risk

1. Our written order confirmation is decisive for the scope of the delivery. Partial deliveries are permitted and shall be noted on the delivery note.

2. Where special tools or parts are ordered, and production based on a specific quantity is not economically possible, we shall be entitled to increase or decrease the order quantity in a manner that is customary in trade by up to 10%, at least however by two items. The actual delivery quantity shall be charged.

3. Where products can only be delivered in a certain packaging unit, we reserve the right to round up to the amount for the next higher quantity of packaging unit.

4. We do not accept any procurement risk for the Goods to be delivered.

5. The cost of dead freight that is the responsibility of the Buyer or his shipping agent shall be borne by the Buyer.

## § 6 Delivery and performance time

1. Binding delivery times must be expressly agreed upon as such in writing. Other delivery time details that are not expressly agreed upon as binding are non-binding or approximate delivery time details, and we shall endeavour to honor these, but from which the Buyer cannot derive any claims for compensation.

2. If, in exceptional cases, binding delivery periods have been agreed, they run from the date on which we confirm an order but not, however, before all technical and commercial details of the order including delivery have been clarified and all the preconditions to be met by the Buyer have been met. Where the Buyer requests amendments after placing an order, and we consent to the amendment or if amendments become absolutely necessary for reasons for which we are not responsible, a new reasonable delivery period shall start to run.

3. The day of collection from us shall be deemed to be the day of delivery, but at the latest 2 days after notification of readiness for dispatch, the Goods shall be deemed to have been delivered. Deliveries prior to expiry of the agreed delivery time are permitted.

4. If events of force majeure (e.g. warlike events, terrorist attacks, natural disasters, nuclear accidents), labor disputes, official measures and other unforeseeable, unavoidable, serious events outside the scope of risk occur to us or the Buyer, the respective contractual party shall be released from its performance obligations for the duration of the disruption and to the extent of its effect. The occurrence of an event of force majeure shall be notified to the respective other party within 3 working days. If the hindrance lasts longer than 3 months, the respective other contracting party shall be entitled, after setting a reasonable grace period, to withdraw from the contract with regard to the part not yet fulfilled. Other rights of termination shall remain unaffected by this provision.

5. In the case of so-called call-off orders, we may request a binding classification two weeks after confirmation of order. If the Buyer fails to honor this request within three weeks, or if the Buyer defaults in acceptance, we shall be entitled to set an additional period of two weeks and once such a period has lapsed withdraw from the contract and claim for damages. Where not agreed to the contrary, as a matter of principle, deliveries ordered by way of a call-off are to be accepted within six months following confirmation of order.

6. Insofar as we are responsible for the failure to meet delivery dates that have been assured with binding force in exceptional cases, the Buyer shall be entitled to compensation of the proven damage sustained by the Buyer as a result of the default but, however, in terms of amount limited at most to 0.5% of the Goods value that is in default for each full week of the default and at most shall be entitled to 5% of the Goods value affected by the default. Compensation for further damage, in particular the loss of expected profit and other indirect damage, is excluded in accordance with Section 9 of these GTCs ("Limitation of Liability").

## § 7 Dispatch and transfer of risk

1. Unless otherwise agreed or stated (e.g. for deliveries within Germany), all deliveries apply ex warehouse or ex works (see Section 3 of these GTCs), which is also deemed the place of performance for potential subsequent performance. As a result, the Buyer is responsible for transport/shipping and the risk of accidental loss or accidental deterioration shall pass to the Buyer upon handover to the carrier/the person otherwise determined in respect of performing the consignment. This also applies to drop shipments.

2. Similarly, the risk of accidental loss/accidental deterioration shall pass to the Buyer upon dispatch if we send the Goods to the Buyer at the Buyer's request. We reserve the right to select the transport route and the means of transport. We are entitled, but do not undertake, to insure deliveries in the name and on account of the Buyer.

3. The handover or acceptance shall continue to apply if the Buyer defaults in acceptance. In addition, in the event of default in acceptance we shall be entitled, but do not undertake, to store the Goods at the Buyer's cost and risk.

4. In the event of a delivery stop as a result of default in payment or acceptance, or for another reason that is the Buyer's responsibility, the risk of the accidental loss/accidental deterioration shall pass to the Buyer at the latest upon notification of the readiness to dispatch.

5. Goods for which notice of readiness for dispatch has been given must be called-off without delay. Otherwise, we shall be entitled to send the Goods at our discretion or store them at the Buyer's cost and risk.

6. If acceptance is proposed or agreed, this is to be performed swiftly, following notification of the readiness for dispatch, at our respective, stated, supply plant. If acceptance is not performed irrespective of the setting of a reasonable additional period, or the Buyer waives acceptance, we shall be entitled to send the Goods without acceptance or store them at the Buyer's cost and risk.

## § 8 Warranty

1. The warranty period is 12 months from the transfer of risk. By contrast, the statutory period applies with respect to claims resulting from the German Product Liability Act or claims attributable to the loss of life, physical injury or detrimental effects on health. Wear-and-tear parts are excluded from the guarantee. We shall not provide any quality guarantees where an individual agreement has not been entered into. Performing work under warranty does not constitute recognition or acceptance of a defect.

2. If the Buyer grants his customer a longer warranty period, this has no effect on the period according to paragraph 1 of this Section.

3. Returns that are not based on a faulty object of sale are not permitted. In the event that a return is permitted in an exceptional case as a result of an express, written agreement, a credit note shall only be issued by way of deducting at least 25% of the purchase price. All return delivery costs shall be borne by the Buyer.

4. In respect of the Buyer's warranty claims, it is required that the Buyer has honored his obligations to inspect and provide notification of defects. We are to be notified in text form of obvious defects within eight calendar days from delivery and notified of hidden de-



fects within the same period from the time at which they are identified. If the Buyer fails to properly inspect and/or provide notification of defects, our liability for the defect for which notification has not been provided, or has not been provided in good time, shall be excluded.

5. If the delivered item is faulty, we may choose whether to provide subsequent performance by way of rectifying the defect (subsequent improvement) or by delivering a fault-free item (replacement). Subsequent performance shall neither entail the dismantling of the faulty item nor new installation if we did not originally undertake to provide installation. The Buyer is to give us the necessary time and opportunity to provide the due subsequent performance, in particular handover the Goods for which notification of defects has been provided for inspection purposes. In the event of replacement, the Buyer is to return the faulty item to us. The limitation period does not begin to run again after subsequent performance.

6. If it becomes clear following an inspection that an item was not faulty, we may request compensation from the Buyer for the costs arising from the unjustified complaint (in particular inspection and transport costs) unless the Buyer could not recognize that the item was not faulty.

7. The Buyer's claims for compensation for loss suffered or reimbursement of expenses incurred in vain shall only apply, including in the case of defects, in accordance with Section 9 and in other respects are excluded.

8. The above limitation periods of the sales law also apply to the Buyer's contractual and non-contractual claims for damages that are based on faulty Goods unless application of the normal statutory limitation period (e.g. §§ 195, 199 BGB) would, in an individual case, result in a shorter limitation period.

#### § 9 Limitation of liability

1. Claims for compensation for loss suffered, irrespective of on which legal grounds these are based, are excluded unless we are to be accused of intent or gross negligence or of violating a key contractual obligation (see paragraph 2 of this Section) more than just insignificantly. Where we are liable for simple negligence, the liability shall be limited to compensation of foreseeable, typical and direct damage. Compensation for indirect or collateral damage such as the loss of expected profit, loss of production and use and pecuniary damage regarding third party claims is excluded.

2. Essential contractual obligations are a) obligations that protect the Buyer's essential contractual legal positions that are to be granted to him in accordance with the content and purpose of the contract and b) such contractual obligations, the honoring of which is required to properly execute the contract and compliance with which the Buyer can normally expect.

3. The aforementioned liability limitations also apply in the case of violations of obligations by, or in favor of, persons whose culpability is our responsibility in accordance with legal requirements. They do not apply if we have fraudulently concealed a defect, in the case of guaranteed provided in an exceptional case, to the Buyer's claims in accordance with the German Product Liability Act or as a result of loss of life, physical injury or detrimental effects on health.

#### § 10 Rental containers and pallets

1. If we make the ordered Goods available to the Buyer on Euro pallets or other re-usable packaging, these are to be replaced by the Buyer within 7 calendar days with replacement items of the same type and value, or are to be returned to us. If this does not occur, we shall be entitled to invoice the Buyer for the used pallets/packaging at the replacement price.

2. In the case of gas deliveries, rental containers or pallets shall only be handed over to the Buyer on a rental basis for the transport, storage and for the Buyer's own use of the acquired gasses. Any other use, or forwarding to third parties, is prohibited. After emptying, the Buyer is to return the containers and pallets to us without delay at his own cost.

3. The Buyer shall be liable for any damage, pollution or loss of rental containers or pallets, and in such cases undertakes to inform us without delay.

4. In respect of surrendered rental containers that are not contrasted with appropriate gas containers for longer than three months, we may request as security an amount in the sum of the respective list price of similar, new, containers. Such an amount falls due for payment immediately. As soon as the Buyer returns a container for which security has been provided, the security shall be returned to the Buyer without interest and less potential repair costs. If the Buyer fails to return the containers, the security amount shall be set off against the compensation for damages payable by the Buyer. Potential residual content in returned containers shall not be remunerated.

#### § 11 Product Discontinuations

We reserve the right to cancel products with 6 months' notice.

#### § 12 Reservation of title

1. We reserve title to the supplied Goods up until all existing claims resulting from the business connection (current account reservation) against the Buyer have been settled in full. Processing/finishing or conversion shall apply at all times in our name and by our order for us, however without any obligation for us, and without loss of our ownership.

2. The parties agree that the reservation of title also applies as extended reservation of title. The Buyer is entitled to sell the Goods during the course of normal business activities. Other disposal is prohibited, in particular an agreement on assignment prohibition with customers is prohibited that could result in the loss of our ownership.

3. The Buyer assigns to us at this point in time any claims to which the Buyer is entitled resulting from the use of the reserved Goods. If the Goods are sold with external items, or used as a substance, the assignment only applies to the revenue part that corresponds to the joint ownership part.

4. The entitlement to resell the object of sale shall become inapplicable if the Buyer discontinues his payment or defaults in payment. In such cases, we shall be entitled to disclose the assignment and collect the claim. The Buyer is to notify us without delay if an application is filed for the institution of insolvency proceedings regarding his assets.

5. The Buyer is only entitled to collect assigned claims during the ordinary course of business activities. The Buyer is to provide notification of third party access to the reserved Goods without delay, and carry the cost of potential intervention. The Buyer is to insure the reserved Goods at replacement value and at its own cost, in particular against theft, water, breakage, fire and other damage. The Buyer is to treat the reserved Goods with due care, in particular comply with the proposed maintenance and use notices.

6. We undertake at the Buyer's request to release securities insofar as the realizable value of the security exceeds the claims that are to be secured by more than 10%. We are free to choose the securities that are to be released.

7. In the event of non-payment of the due purchase price irrespective of a reasonable additional period or if this can be dispensed with, we shall be entitled, in ac-

cordance with the statutory requirements, to withdraw from the contract and/or demand return of the Goods as a result of the reservation of title. The demand for the return of the Goods does not simultaneously contain a statement of withdrawal. Moreover, we are entitled to merely demand the return of the Goods and reserve the right to withdraw.

8. For the duration of the reservation of title, in the event of the occurrence of damage we shall be entitled to all rights resulting from insurance policies entered into by the Buyer. In the absence of agreements to the contrary, benefits resulting from the comprehensive insurance are to be used in full for the repair of the delivery item. If a repair is waived following our approval in the case of severe damage, we shall use the insurance benefit to repay the purchase price and the cost of ancillary performance.

#### § 13 Resale and export restrictions

1. Subject to deviating individual agreements, the Goods purchased from us are only intended for use within the territorial scope of the legal framework existing at the place of delivery. The catalogued offer of a product as a country version for a specific country or territory is equivalent to an individual agreement in this respect.

2. The transfer of the Goods purchased from us to a country other than that of the place of delivery is prohibited if the transfer violates an existing and subsequent export ban. This applies in particular to legal export restrictions, war weapons control, boycotts, embargoes and US sanctions.

3. Failure to comply with the limitation of paragraph 2 of this Section constitutes a serious breach of contract which entitles us to withdraw from the contract or to terminate the contract and obliges the customer to compensate for all damages and disadvantages incurred by us.

#### § 14 Applicable law, place of jurisdiction

1. The law of the Federal Republic of Germany applies to these General Terms and Conditions of Sale and the legal relations between us and the Buyer, by way of exclusion of international uniform law, in particular the UN Convention on Contracts for the International Sale of Goods (CISG) and the conflict of laws.

2. The place of business stated in paragraph 1 of this Section is deemed the exclusive, including the international, place of jurisdiction for all disputes resulting directly or indirectly from the contractual relationship. However, in all cases we are also entitled to bring legal action at the place of performance of the delivery obligation in accordance with these General Terms and Conditions of Sale or at the Buyer's general place of jurisdiction. This does not affect prior-ranking statutory requirements, in particular in respect of exclusive places of jurisdiction.

#### § 15 Severability clause

In the event that individual provisions of these General Terms and Conditions of Sale are or become invalid, this shall not affect the validity of the other provisions. The parties undertake to replace the invalid provision with a legally valid regulation that comes closest to the economic objective of the invalid provision.

Date: June 2022

## Additional terms of delivery and payment for Germany

The following terms apply in addition to the general conditions for the sale of Goods (Pages 382–383):

#### Surcharges:

<b>Hazardous material</b>	€ 9.50 surcharge for dangerous Goods, per delivery
<b>Solder material</b>	The prices for solder material depend largely on the current silver and copper prices. Price surcharges due to increased raw material prices are reserved; please ask for the current prices.
<b>Route delivery</b>	€ 5.00
<b>Minimum quantities</b>	For orders under € 250.00 net surcharge of € 15.00

#### Shipping / Shipping costs flat rate within Germany:

Shipping is carried out by us via transport carriers of our choice. We charge a flat rate for this:

Goods value	Surcharge	Flat rates
Up to € 250.00	€ 15.00	€ 12.00 net
Up to € 399.99	-	€ 12.00 net
As of € 400.00	-	free house

#### Payment of deliveries within EU, EFTA and UK:

30 days net from invoice date (no discount)

#### Payment of deliveries outside the EU, EFTA and UK:

Prepayment



## Imprint

This catalog is a publication of

### **ROTHENBERGER Werkzeuge GmbH**

Industriestraße 7

65779 Kelkheim (Taunus)

Germany

Phone +49 6195 800-0

Fax +49 6195 800-3500

info@rothenberger.com

Company register and number: Königstein im Taunus, HRB 2732

Great care was taken in compiling this catalog and reproduction of the product information. Nevertheless we cannot completely exclude the possibility of error. For this reason, ROTHENBERGER disclaims any liability for any errors which may have arisen despite careful checking of the contents.

The design, compilations, performance data, features, dimensions and weight of products can alter as a result of further technical developments and adaptation of our products to the requirements and wishes of our customers, without any duty on our part to announce this in advance.

We are not obliged to alter already delivered products to match such new developments. We also reserve the right to remove articles from our product program.

This catalog invalidates all previous versions. Standard specifications are non-binding. The operating instructions and suggestions for use and safety are non-binding and do not in any way replace legal or other regulations, such as employer's liability insurance association regulations, in the respective countries.

No part of this catalog may be reproduced in any way whether by reprinting, photocopying, putting onto microfilm or any other process, or be converted into a machine-readable language or stored in any electronic systems and processed there without prior written permission from ROTHENBERGER Werkzeuge GmbH.

It is not permitted to make any changes and additions to the catalog. We reserve all rights for all countries.

© 2024 ROTHENBERGER Werkzeuge GmbH, Germany

# ROTHENBERGER worldwide

<b>Australia</b>	ROTHENBERGER Australia Pty. Ltd. Unit 6/13 Hoyle Avenue Castle Hill NSW 2154 Australia Phone: +61 2 9899 7577 sales-au@rothenberger.com rothenberger.com.au	rothenberger.nl
<b>Austria</b>	ROTHENBERGER Werkzeuge und Maschinen Handelsgesellschaft mbH Gewerbeparkstraße 9, 5081 Anif, Austria Phone: +43 6246 72091 -250, Fax: +43 6246 72091 -215 office@rothenberger.at rothenberger.com/at-de	<b>Poland</b> ROTHENBERGER Polska Sp. z o.o. Ul. Annopol 4A, Hala C, PL-03-236 Warszawa, Poland Phone: +48 22 213 59 00 biuro@rothenberger.pl rothenberger.pl
<b>Belgium</b>	ROTHENBERGER Benelux bv Antwerpsesteenweg 59, 2630 Aartselaar, Belgium Phone: +32 3 877 22 77, Fax: +32 3 877 03 94 info@rothenberger.be rothenberger.be	<b>Sweden</b> ROTHENBERGER WERKZEUGE GmbH Sales Office Nordic c/o SIEVERT AB P.O. Box 1366 SE-171 26 Solna, Sweden Visiting address: Hemvärnsgatan 22, Solna, Sweden Phone: +46 8 629 2299 roscan@rothenberger.com
<b>Brazil</b>	ROTHENBERGER do Brasil LTDA Avenida Fagundes de Oliveira, 538 Galpão A4, Piraporinha, Diadema, Sao Paulo, Brazil Phone: +55 11 4044 4748 contato-br@rothenberger.com rothenberger.com.br	<b>South Africa</b> ROTHENBERGER TOOLS SA (Pty) Ltd P.O. Box 4360, Edenvale 1610 165 Van Der Bijl Street, Meadowdale Germiston Gauteng (Johannesburg), South Africa Phone: +27 11 372 9631, Fax: +27 11 372 9632 info@rothenberger.co.za rothenberger.com/za-en
<b>Bulgaria</b>	ROTHENBERGER Bulgaria EOOD Blvd. Sitnjakovo 79, BG-1111 Sofia, Bulgaria Phone: +359 2 946 14 59 info@rothenberger.bg rothenberger.com/bg-bg	<b>Spain</b> ROTHENBERGER Werkzeuge GmbH Ctra. Durango-Elorrio, Km. 2, 48220 Abadiano (Vizcaya), Spain Phone: +34 94 621 01 00, Fax: +34 94 621 01 02 ventas@rothenberger.com rothenberger.es
<b>China</b>	ROTHENBERGER (Wuxi) Pipe Technologies Co., Ltd. Building D, No 9 Lianhe Road Hudai Industrial Park, 214161 Wuxi, Jiangsu, China Phone: 00886-13681711513, Fax: +86 0510 83217263 lily.xu@rothenberger.cn	<b>Switzerland</b> ROTHENBERGER (Schweiz) AG Herostr. 9, CH-8048 Zürich, Switzerland Phone: +41 44 435 30 30, Fax: +41 44 401 06 08 info@rothenberger-werkzeuge.ch
<b>Czech Republic</b>	ROTHENBERGER CZ Prumyslova 1306/7, 102 00 Praha 10, Czech Republic Phone: +420 271 730 183 prodej@rothenberger.com rothenberger.cz	<b>Turkey</b> ROTHENBERGER Türkiye ROTHENBERGER Center, Barbaros Bulvarı No:9 TR-34775 Şerifali/Ümraniye İstanbul, Turkey Phone: +90 216 449 24 85, Fax: +90 216 449 24 87 rothenberger@rothenberger.com.tr rothenberger.com.tr
<b>France</b>	ROTHENBERGER France 39 Quai de Marne, F-51206, Épernay, Cedex, France Phone: +33 3 87 74 92 92 info-fr@rothenberger.com rothenberger.fr	<b>UAE</b> ROTHENBERGER Middle East FZCO PO Box 261190, Jebel Ali Free Zone Dubai, United Arab Emirates Phone: +971 4 883 97 77, Fax: +971 4 883 97 57 office-ae@rothenberger.com  ROTHENBERGER Middle East Equipment Trading LLC PO Box 261190, Al Quoz Industrial Area 3 Dubai, United Arab Emirates Phone: +971 4 885 48 65, Fax: +971 4 883 97 57 servicecenter-ae@rothenberger.com
<b>Germany</b>	ROTHENBERGER Deutschland GmbH Industriestraße 7, 65779 Kelkheim (Taunus), Germany Phone: +49 6195 800 -0, Fax: +49 6195 800 -3500 verkauf-deutschland@rothenberger.com rothenberger.com	<b>UK</b> ROTHENBERGER UK Ltd. 2, Kingsthorpe Park, Henson Way Kettering, GB-Northants NN16 8PX, UK Phone: +44 15 36 31 03 00, Fax: +44 15 36 31 06 00 sales@rothenberger.co.uk
<b>Greece</b>	ROTHENBERGER Hellas S.A. Head Office: 5 Amfitheas Av., 17122 N. Smyrni, Greece Warehouse: 45 Agias Kyriakis Str., 17564 P. Faliro, Greece Phone: +30 21 09 40 20 49, +30 21 09 40 73 02-3 Fax: +30 21 09 40 73 22 ro-he@otenet.gr rothenberger.com	<b>USA</b> ROTHENBERGER USA Inc. 7130 Clinton Road, Loves Park, IL 61111, USA Phone: +1 80 05 45 76 98, Fax: +1 81 56 33 08 79 customerservice-us@rothenberger.com rothenberger.com/us-en
<b>Hungary</b>	ROTHENBERGER Szerszám és Gép Kereskedelmi Kft. Gubacsi út 24, H-1097 Budapest, Hungary Phone: +36 1 3 47 50 40, Fax: +36 1 3 47 50 59 info-hu@rothenberger.com rothenberger.hu	
<b>India</b>	ROTHENBERGER India Pvt. Ltd. Unit No. 410, 4th Floor, Vipul Business Park Sohna Road, Sector-48, Gurgaon -122018, India Phone: +91 9873840900 rothenberger.in	
<b>Italy</b>	ROTHENBERGER Italiana s.r.l. Via G. Reiss Romoli 17-19, I-20019 Settimo Milanese, Italy Phone: +39 02 33 50 601 rothenberger.italia@rothenberger.com rothenberger.it	
<b>Netherlands</b>	ROTHENBERGER Nederland bv Postbus 45, NL-5120 AA Rijen, Netherlands Phone: +31 1 61 29 35 79, Fax: +31 1 61 29 39 08 info@rothenberger.nl	

---

## ROTHENBERGER Partners

<b>Romania</b>	ROWALT S.R.L. Strada 1 Mai, nr. 4, Otopeni, Ilfov, 075100, Romania Phone: +40 21 350 37 44/45/46 info@rothenberger.ro rothenberger-romania.ro
<b>Ukraine</b>	ROTHENBERGER-CENTER LTD. Salskoho str. 11, Kyiv, 04060, Ukraine Phone: +380 444941597 info@rothenberger.com.ua

**ROTHENBERGER**  
pipetool technologies at work



**We connect people with water and energy.  
Safe. Sustainable.**



 **Carbon neutral**  
Print product  
ClimatePartner.com/11798-2311-1001

**ROTHENBERGER Werkzeuge GmbH**  
Industriestraße 7  
65779 Kelkheim (Taunus)  
Germany

Phone +49 6195 800 - 0  
Fax +49 6195 800 - 3500  
info@rothenberger.com



**rothenberger.com**